



UNIVERZA NA PRIMORSKEM  
FAKULTETA ZA MATEMATIKO, NARAVOSLOVJE IN  
INFORMACIJSKE TEHNOLOGIJE

DOKTORSKA DISERTACIJA  
(DOCTORAL THESIS)

**O TERWILLIGERJEVI ALGEBRI DVODELNIH  
RAZDALJNO-REGULARNIH GRAFOV  
(ON THE TERWILLIGER ALGEBRA OF  
BIPARTITE DISTANCE-REGULAR GRAPHS)**

SAFET PENJIĆ

KOPER, 2019



UNIVERZA NA PRIMORSKEM  
FAKULTETA ZA MATEMATIKO, NARAVOSLOVJE IN  
INFORMACIJSKE TEHNOLOGIJE

DOKTORSKA DISERTACIJA  
(DOCTORAL THESIS)

**O TERWILLIGERJEVI ALGEBRI  
DVODELNIH RAZDALJNO-REGULARNIH  
GRAFOV  
(ON THE TERWILLIGER ALGEBRA OF  
BIPARTITE DISTANCE-REGULAR  
GRAPHS)**

SAFET PENJIĆ



---

# Acknowledgement

---

I would like to express my sincere gratitude to my supervisor Štefko Miklavič for introducing me to distance-regular graphs, to the Terwilliger algebra, for his patience and for all help and healthy discussions during my PhD studies. I would like to thank him for helpful and constructive comments that greatly contributed to improving the final version of this PhD thesis. I am also very grateful to Mark S. MacLean for all his help, support, and valuable discussions - among else, he has been my academic advisor during my Foreign Fulbright student program; Mark hosted me at Seattle University (Seattle, USA) in the period from November 2018 till May 2019. Of course, I thank the prestigious Fulbright Foreign Student Program for the 2018-2019 academic year together with the Fulbright Office in Bosnia and Herzegovina, that allowed me to undertake research in mathematics at Seattle University - Graduate School.

I am very grateful to Erasmus+ program (Erasmus+ KA103 and KA107 staff mobility for teaching) that allowed me to make research visits and to share my research and my teaching experience with students and professors from Beijing Jiaotong University (Beijing, China), Universidad Del Pais Vasco/Euskal Herriko Unibertsitatea (Bilbao, Spain), Indian Institute of Technology (Roorkee, India) and The University of Western Australia (Perth, Australia). I am also very grateful to professors from each of these four institutions that helped me to make these research visits. Without them my research probably would not be so fruitful.

I would also like to thank all the personnel of the Faculty of Mathematics, Natural Sciences and Information Technologies and Andrej Marušič Institute who made the process of my study smooth.

In the end, I would not have been able to complete this without some amazing people for whose help I am immeasurably grateful: to my parents for believing this PhD thesis would (one day) see the light.

Safet Penjić



---

# Abstract

---

Distance-regular graphs are highly regular combinatorial objects which must satisfy a number of strong conditions. A wish (which is currently beyond our reach) is a classification of those with sufficiently large diameter. The Terwilliger algebra was introduced to help in this project. There has been some success in relating local conditions plus an additional global regularity to the structure of the Terwilliger algebra. Much, but certainly not all, work in this program has focused on the  $Q$ -polynomial case. The present PhD Thesis fits in this program, tackling a situation related to the  $Q$ -polynomial case. On the other hand this PhD Thesis is also part of a program to relate algebraic and combinatorial properties of (bipartite) distance-regular graphs.

Our central results are the following. Let  $\Gamma = (X, \mathcal{R})$  denote a bipartite distance-regular graph with diameter  $D \geq 4$  and valency  $k \geq 3$ .

- For a bipartite  $Q$ -polynomial distance-regular graph  $\Gamma$  with  $c_2 \leq 2$ : We show that  $\Gamma$  is either the  $D$ -dimensional hypercube, or the antipodal quotient of the  $2D$ -dimensional hypercube, or  $D = 5$ .

Let (a.1) denote the following property of  $\Gamma$ : for  $2 \leq i \leq D - 1$ , there exist complex scalars  $\alpha_i, \beta_i$  such that for all  $x, y, z \in X$  with  $\partial(x, y) = 2, \partial(x, z) = i, \partial(y, z) = i$ , we have  $\alpha_i + \beta_i |\Gamma_1(x) \cap \Gamma_1(y) \cap \Gamma_{i-1}(z)| = |\Gamma_{i-1}(x) \cap \Gamma_{i-1}(y) \cap \Gamma_1(z)|$ . Note that if  $\Gamma$  is  $Q$ -polynomial then (a.1) holds (and the converse is not true).

Suppose the graph  $\Gamma$  satisfies the property (a.1). For that case we showed the following.

- We found an equitable partition for  $\Gamma$  when  $c_2 \in \{1, 2\}$ .
- We showed that for any irreducible  $T$ -module  $W$  with endpoint 2 we have

$$W = \text{span}\{v_2^+, v_3^+, \dots, v_D^+, v_2^-, v_3^-, \dots, v_{D-2}^-\},$$

where  $v \in E_2^*W$  ( $v \neq \mathbf{0}$ ),  $v_i^+ = E_i^*A_{i-2}E_2^*v$ , and  $v_i^- = E_i^*A_{i+2}E_2^*v$ .

Let us define parameters  $\Delta_i$  ( $1 \leq i \leq D - 1$ ) in terms of the intersection numbers by  $\Delta_i = (b_{i-1} - 1)(c_{i+1} - 1) - (c_2 - 1)p_{2i}^i$ . Let (a.2) denote the following:  $\Delta_2 = 0, \Delta_i \neq 0$  for at least one  $i$  ( $3 \leq i \leq D - 2$ ), and (a.1) holds.

Suppose the graph  $\Gamma$  satisfies the property (a.2) and  $c_2 = 1$ . For this case we showed the following.

- We found the structure of irreducible  $T$ -modules of endpoint 2.
- We showed that up to isomorphism there exists exactly one irreducible  $T$ -module with endpoint 2, and this module is not thin.
- We gave a basis for this irreducible  $T$ -module, and gave the action of  $A$  on this basis.

Suppose the graph  $\Gamma$  satisfies the property (a.2) and  $c_2 = 2$ . Then we showed the following.

- We found the structure of irreducible  $T$ -modules of endpoint 2.
- We showed that up to isomorphism there exists exactly one irreducible  $T$ -module with endpoint 2, and this module is not thin.
- We gave a basis for this irreducible  $T$ -module, and we gave the action of  $A$  on this basis.

Suppose the graph  $\Gamma$  satisfies the property (a.2) and  $D \leq 5$ . We showed the following.

- We found the structure of irreducible  $T$ -modules of endpoint 2 for graphs  $\Gamma$ .
- We showed that up to isomorphism there exists exactly one irreducible  $T$ -module with endpoint 2 and it is not thin.
- We gave a basis for this irreducible  $T$ -module, and we gave the action of  $A$  on this basis.

**Math. Subj. Class (2010):** 05C50, 05E30

**Key words:** bipartite distance-regular graph, Terwilliger algebra, Subconstituent algebra,  $Q$ -polynomial property, equitable partition



---

# Izveček

---

Razdaljno-regularni grafi so kombinatorični objekti z visoko stopnjo regularnosti. Želja (ki je, kot kaže, trenutno nedosegljiva) je klasifikacija razdaljno-regularnih grafov z dovolj velikim premerom. Terwilligerjeva algebra je bil definirana in vpeljana v raziskovanje razdaljno-regularnih grafov kot pomoč pri tem projektu. V procesu klasifikacije je bil dosežen določen uspeh. Veliko dela (vsekakor ne vse) v tem programu se je osredotočilo na  $Q$ -polinomske razdaljno-regularne grafe. Ta doktorska disertacija sodi v ta program, saj proučuje primere, ki so tesno povezani s  $Q$ -polinomskimi razdaljno-regularnimi grafi. Po drugi strani je ta doktorska disertacija tudi del programa, ki ima za svoj cilj povezati algebraične in kombinatorične lastnosti (dvodelnih) razdaljno-regularnih grafov, ter te povezave tudi pojasniti in interpretirati.

Naj bo  $\Gamma = (X, \mathcal{R})$  dvodelen razdaljno-regularen graf s premerom  $D \geq 4$  in stopnjo  $k \geq 3$ . Znanstveni prispevki te disertacije so sledeči:

- Za dvodelne  $Q$ -polinomske razdaljno-regularne grafe  $\Gamma$  s  $c_2 \leq 2$  smo pokazali, da je  $\Gamma$  bodisi  $D$ -dimenzionalna hiperkocka, bodisi antipodni kvocient  $2D$ -dimenzionalne hiperkocke, bodisi je  $D = 5$ .

Naj bo (a.1) naslednja lastnost grafa  $\Gamma$ : za vsak  $2 \leq i \leq D - 1$  obstajajo taka kompleksna števila  $\alpha_i, \beta_i$ , da za vse  $x, y, z \in X$  z lastnostjo  $\partial(x, y) = 2, \partial(x, z) = i, \partial(y, z) = i$  velja, da je  $\alpha_i + \beta_i |\Gamma_1(x) \cap \Gamma_1(y) \cap \Gamma_{i-1}(z)| = |\Gamma_{i-1}(x) \cap \Gamma_{i-1}(y) \cap \Gamma_1(z)|$ . Opazimo da, če je graf  $\Gamma$   $Q$ -polinomski, potem ima vedno lastnost (a.1) (obratno ne drži vedno).

Za grafe  $\Gamma$ , ki imajo lastnost (a.1):

- Podali smo opis ekvitalne particije grafa  $\Gamma$ , v primeru, ko je  $c_2 \in \{1, 2\}$ .
- Pokazali smo, da za vsak nerazcepen  $T$ -modul s krajiščem 2 velja

$$W = \text{span}\{v_2^+, v_3^+, \dots, v_D^+, v_2^-, v_3^-, \dots, v_{D-2}^-\},$$

kjer je  $v \in E_2^* W$  ( $v \neq \mathbf{0}$ ),  $v_i^+ = E_i^* A_{i-2} E_2^* v$  in  $v_i^- = E_i^* A_{i+2} E_2^* v$ .

Definirajmo parametre  $\Delta_i$  ( $1 \leq i \leq D - 1$ ) s prepisom  $\Delta_i = (b_{i-1} - 1)(c_{i+1} - 1) - (c_2 - 1)p_{2i}^i$ , in naj bo (a.2) naslednja lastnost:  $\Delta_2 = 0, \Delta_i \neq 0$  za nek  $i$  ( $3 \leq i \leq D - 2$ ), in  $\Gamma$  ima lastnost (a.1).

Za grafe  $\Gamma$ , ki imajo lastnost (a.2) in  $c_2 = 1$ :

- Opisali smo strukturo nerazcepnih  $T$ -modulov s krajiščem 2.
- Pokazali smo, da do izomorfizma natančno obstaja en sam nerazcepen  $T$ -modul s krajiščem 2, ter da ta modul ni tanek.
- Podali smo bazo nerazcepnega  $T$ -modula s krajiščem 2. Opisali smo delovanje matrike sosednosti  $A$  na tej bazi.

Za grafe  $\Gamma$ , ki imajo lastnost (a.2) in  $c_2 = 2$ :

- Opisali smo strukturo nerazcepnih  $T$ -modulov s krajiščem 2.
- Pokazali smo, da do izomorfizma natančno obstaja en sam nerazcepen  $T$ -modul s krajiščem 2, ter da ta modul ni tanek.
- Podali smo bazo nerazcepnega  $T$ -modula s krajiščem 2. Opisali smo delovanje matrike sosednosti  $A$  na tej bazi.

Za grafe  $\Gamma$ , ki imajo lastnost (a.2) in  $D \leq 5$ :

- Opisali smo strukturo nerazcepnih  $T$ -modulov s krajiščem 2.
- Pokazali smo, da do izomorfizma natančno obstaja en sam nerazcepen  $T$ -modul s krajiščem 2, ter da ta modul ni tanek.
- Podali smo bazo nerazcepnega  $T$ -modula s krajiščem 2. Opisali smo delovanje matrike sosednosti  $A$  na tej bazi.

**Math. Subj. Class (2010):** 05C50, 05E30

**Ključne besede:** dvodelni razdaljno-regularni grafi, Terwilligerjeva algebra, Sferična algebra,  $Q$ -polinomski razdaljno-regularni grafi, ekvitalna particija

---

# Contents

---

<b>Acknowledgement</b>	<b>iii</b>
<b>Abstract</b>	<b>v</b>
<b>Izveček</b>	<b>vii</b>
<b>Contents</b>	<b>ix</b>
<b>1 Introduction</b>	<b>1</b>
<b>2 Background: Adjacency and Bose-Mesner algebras</b>	<b>4</b>
2.1 Basic definitions . . . . .	4
2.2 Primitive idempotents . . . . .	6
2.3 Adjacency and Bose-Mesner algebras . . . . .	10
2.4 Inner products on $\text{Mat}_X(\mathbb{F})$ and $\mathbb{F}_d[x]$ . . . . .	13
2.5 Krein parameters $q_{ij}^h$ . . . . .	16
2.5.1 The operator $\rho(x)$ . . . . .	18
<b>3 Distance-regular graphs</b>	<b>20</b>
3.1 Distance-regular graph . . . . .	20
3.2 Standard module . . . . .	23
3.3 Dual eigenvalue sequence . . . . .	24
3.4 The $Q$ -polynomial property . . . . .	24
3.5 Examples . . . . .	26
3.5.1 Johnson graphs . . . . .	27
3.5.2 Hamming Graphs and Cubes . . . . .	27
3.5.3 Halved Cubes . . . . .	28
3.5.4 Antipodal quotients of cubes . . . . .	28
<b>4 On bipartite QDRG with <math>c_2 \leq 2</math></b>	<b>29</b>
4.1 The case $D \geq 6$ . . . . .	29
4.2 The partition - part I . . . . .	31
4.3 The partition - part II . . . . .	35
4.4 The case $D = 4$ . . . . .	37
<b>5 Terwilliger algebra</b>	<b>41</b>
5.1 Dual Bose-Mesner algebra . . . . .	41
5.2 Terwilliger algebra . . . . .	41
5.3 Irreducible $T$ -module with endpoint 0 . . . . .	45
5.4 Irreducible $T$ -modules with endpoint 1 . . . . .	46

5.5	Note about the case when $\Gamma$ is thin . . . . .	47
5.6	The raising and lowering matrices . . . . .	48
<b>6</b>	<b>The scalars <math>\Delta_i</math></b>	<b>49</b>
<b>7</b>	<b>On the Terwilliger algebra of a bipartite DRG with <math>c_2 = 1</math></b>	<b>52</b>
7.1	Maps $G_i, H_i$ and $I_i$ . . . . .	52
7.2	The sets $\mathcal{D}_i^i(0), \mathcal{D}_i^i(1)$ and the partition . . . . .	54
7.3	Some products in $T$ . . . . .	57
7.4	More products in $T$ . . . . .	59
7.5	Some scalar products . . . . .	61
7.6	The irreducible $T$ -modules with endpoint 2 . . . . .	62
7.7	The irreducible $T$ -modules with endpoint 2: the $A$ -action . . . . .	63
7.8	The isomorphism class of an irreducible $T$ -module with endpoint 2 . . . . .	64
<b>8</b>	<b>On the Terwilliger algebra of a bipartite DRG with <math>c_2 = 2</math></b>	<b>65</b>
8.1	The sets $\mathcal{D}_j^i, \mathcal{D}_i^i(0), \mathcal{D}_i^i(1)$ and $\mathcal{D}_i^i(2)$ . . . . .	65
8.2	Maps $G_i, H_i$ and $I_i$ . . . . .	69
8.3	Equitable partition . . . . .	70
8.4	Some products in $T$ . . . . .	71
8.5	More products in $T$ . . . . .	73
8.6	Some scalar products . . . . .	74
8.7	The irreducible $T$ -modules with endpoint 2 . . . . .	76
8.8	The irreducible $T$ -modules with endpoint 2: the $A$ -action . . . . .	77
8.9	The isomorphism class . . . . .	78
<b>9</b>	<b>On the Terwilliger algebra of a bipartite DRG with <math>D \leq 5</math></b>	<b>79</b>
9.1	Background . . . . .	79
9.2	Some products in $T$ . . . . .	80
9.3	Irreducible $T$ -modules with endpoint 2 . . . . .	81
9.4	The case $\Delta_2 = 0$ and $\Delta_3 \neq 0$ . . . . .	82
9.5	Some scalar products . . . . .	83
9.6	A basis . . . . .	85
	<b>Bibliography</b>	<b>87</b>
	<b>Index</b>	<b>90</b>
	<b>List of Figures</b>	<b>93</b>
	<b>Povzetek v slovenskem jeziku</b>	<b>94</b>
	Kazalo . . . . .	103
	Stvarno kazalo . . . . .	106
	<b>Declaration</b>	<b>107</b>

# Introduction

---

Throughout this introduction let  $\Gamma$  denote a bipartite distance-regular graph with diameter  $D \geq 4$  and valency  $k \geq 3$ . Let  $X$  denote the vertex set of  $\Gamma$ . For  $x \in X$  and  $0 \leq i \leq D$ , let  $\Gamma_i(x)$  denote the set of vertices in  $X$  that are distance  $i$  from vertex  $x$ , and let  $T = T(x)$  denote the Terwilliger algebra of  $\Gamma$  with respect to  $x$ . To each irreducible  $T$ -module we associate two parameters - the endpoint and the diameter. It turns out that the dimension of such a module is at least one more than its diameter. Whenever this bound is met, we say that the module is thin.

It is known that there exists a unique irreducible  $T$ -module with endpoint 0, it is thin, and it has diameter  $D$  [9, Section 5]. It is also known that up to isomorphism  $\Gamma$  has exactly one irreducible  $T$ -module with endpoint 1, it is thin, and it has diameter  $D - 2$  [9, Theorem 7.6, Corollary 7.7]. Moreover, Curtin showed that in general, there may be many nonisomorphic irreducible  $T$ -modules of endpoint 2, they need not be thin, and their diameter is one of  $D - 2$ ,  $D - 3$  and  $D - 4$  [10, Theorem 10.1], [11].

To explain our motivation, let us define parameters  $\Delta_i$  ( $1 \leq i \leq D - 1$ ) in terms of the intersection numbers by  $\Delta_i = (b_{i-1} - 1)(c_{i+1} - 1) - (c_2 - 1)p_{2i}^i$ , and just for a moment consider a graph  $\Gamma$  with one of the following properties:

- (a.1)  $\Gamma$  has, up to isomorphism, a unique irreducible  $T$ -module of endpoint 2 and this module is thin.
- (a.2)  $\Gamma$  has, up to isomorphism, exactly two irreducible  $T$ -modules of endpoint 2, and these modules are thin.
- (a.3)  $\Gamma$  has, up to isomorphism, a unique irreducible  $T$ -module  $W$  of endpoint 2, this module is not thin,  $\dim(E_i^*W) \leq 2$  for every  $i$  ( $2 \leq i \leq D$ ),  $\dim(E_2^*W) = 1$  and  $\dim(E_{D-1}^*W) \leq 1$ .
- (a.4)  $\Delta_i = 0$  for every  $i$  ( $1 \leq i \leq D - 1$ ).
- (a.5)  $\Delta_i = 0$  for every  $i$  ( $1 \leq i \leq D - 2$ ).
- (a.6) For all  $i$  ( $1 \leq i \leq D - 2$ ) and for all  $x, y, z \in X$  with  $\partial(x, y) = 2$ ,  $\partial(x, z) = i$ ,  $\partial(y, z) = i$ , the number  $|\Gamma_1(x) \cap \Gamma_1(y) \cap \Gamma_{i-1}(z)|$  is independent of  $x, y, z$ .
- (a.7)  $\Gamma$  has the property that for  $2 \leq i \leq D - 1$ , there exist complex scalars  $\alpha_i, \beta_i$  such that for all  $x, y, z \in X$  with  $\partial(x, y) = 2$ ,  $\partial(x, z) = i$ ,  $\partial(y, z) = i$ , we have

$$\alpha_i + \beta_i |\Gamma_1(x) \cap \Gamma_1(y) \cap \Gamma_{i-1}(z)| = |\Gamma_{i-1}(x) \cap \Gamma_{i-1}(y) \cap \Gamma_1(z)|.$$

- (a.8)  $\Gamma$  has the property that for  $2 \leq i \leq D - 2$ , there exist complex scalars  $\alpha_i, \beta_i$  such that for all  $x, y, z \in X$  with  $\partial(x, y) = 2$ ,  $\partial(x, z) = i$ ,  $\partial(y, z) = i$ , we have

$$\alpha_i + \beta_i |\Gamma_1(x) \cap \Gamma_1(y) \cap \Gamma_{i-1}(z)| = |\Gamma_{i-1}(x) \cap \Gamma_{i-1}(y) \cap \Gamma_1(z)|.$$

(a.9)  $\Delta_2 > 0$  and (a.8) holds.

(a.10)  $\Delta_2 = 0$ ,  $\Delta_i \neq 0$  for at least one  $i$  ( $3 \leq i \leq D - 1$ ), and (a.7) holds.

Curtin [8, 12] showed that properties (a.1), (a.5) and (a.6) are equivalent. Moreover, (a.4) holds if and only if (a.1) and (a.5) hold and the unique irreducible  $T$ -module of endpoint 2 has diameter  $D - 4$ . MacLean and Miklavič [27, Theorem 9.6] showed that properties (a.2) and (a.9) are equivalent.

Several chapters of the present thesis are part of an effort to show that the properties (a.3) and (a.10) are equivalent. We are interested in bipartite distance-regular graphs with property (a.7), because they arise as a natural family in the study of the Terwilliger algebra of a bipartite distance-regular graph, as by the following very important example indicates.

Suppose that  $\Gamma$  is  $Q$ -polynomial. Then  $\Gamma$  has, up to isomorphism, at most one irreducible  $T$ -module of endpoint 2 and diameter  $D - 2$ , at most one irreducible  $T$ -module of endpoint 2 and diameter  $D - 4$  (they are both thin), and no other irreducible  $T$ -modules of endpoint 2 [5]. Furthermore, Terwilliger's *balanced set condition* ([48, Theorem 3.3]) implies the property (a.7) (see [34, Theorem 9.1]).

In the first part of the thesis we assume  $\Gamma$  is a bipartite  $Q$ -polynomial distance-regular graph with diameter  $D \geq 4$  and valency  $k \geq 3$ . Caughman [6] proved that if  $D \geq 12$  then  $\Gamma$  is either the  $D$ -dimensional hypercube, or the antipodal quotient of the  $2D$ -dimensional hypercube, or the intersection numbers of  $\Gamma$  satisfy  $c_i = (q^i - 1)/(q - 1)$  ( $0 \leq i \leq D$ ) for some integer  $q$  at least 2. Note that if  $c_2 \leq 2$ , then the last of the above possibilities cannot occur. The aim of the first part of the thesis is to further investigate these graphs. We will show that if  $c_2 \leq 2$  then  $\Gamma$  is either the  $D$ -dimensional hypercube, or the antipodal quotient of the  $2D$ -dimensional hypercube, or  $D = 5$ .

In the second part of the thesis we will not assume the  $Q$ -polynomial property for  $\Gamma$ , but rather the property (a.7). It is our goal to describe the irreducible  $T$ -modules with endpoint 2 for this case. Once we assume (a.7), to get further results, it is much easier to split (a.7) in two cases, with respect to parameter  $\Delta_2$ : the case when  $\Delta_2 > 0$  and the case when  $\Delta_2 = 0$  (by [8, Theorem 12],  $\Delta_2$  is non-negative). Since  $\Delta_2 > 0$  yields (a.2) [27], here we assume that  $\Delta_2 = 0$ . By [28, Theorem 4.4], this implies  $D \leq 5$  or  $c_2 \in \{1, 2\}$ . In light of this result, it is natural to treat cases  $c_2 = 1$ ,  $c_2 = 2$  and  $D \leq 5$  separately. If (a.10) holds and  $c_2 = 1$ , then it was proven in [28] that (a.3) holds (in that case the unique irreducible  $T$ -module of endpoint 2 is not thin and the diameter of this module is  $D - 4$  or  $D - 2$ ). In this paper we assume  $c_2 = 2$ . We assume that  $\Delta_i \neq 0$  for at least one  $i$  ( $3 \leq i \leq D - 2$ ), since graphs with property (a.4) are already well-understood ([12]). We describe the irreducible  $T$ -modules with endpoint 2 for this case.

Chapters 2 and 3 contain some definitions and basic concepts on Bose-Mesner algebra and distance-regular graph theory.

The main result of Chapter 4 is the following theorem.

**Theorem 1.1** *Let  $\Gamma$  denote a bipartite  $Q$ -polynomial distance-regular graph with diameter  $D \geq 4$ , valency  $k \geq 3$ , and intersection number  $c_2 \leq 2$ . Then one of the following holds:*

- (i)  $\Gamma$  is the  $D$ -dimensional hypercube;
- (ii)  $\Gamma$  is the antipodal quotient of the  $2D$ -dimensional hypercube;
- (iii)  $\Gamma$  is a graph with  $D = 5$  not listed above.

To prove the above theorem we use the results of Caughman [5] and, in case when  $c_2 = 2$ , a certain equitable partition of the vertex set of  $\Gamma$ , which involves  $4(D - 1) + 2\ell$  cells for some integer  $\ell$  with  $0 \leq \ell \leq D - 2$ .

Chapter 5 contains some definitions and basic concepts on the theory of Terwilliger algebra. In Chapter 6 we define (and study) scalars  $\Delta_i$  which will be used till the end of the thesis.

Let

$$f = \min\{i \in \mathbb{N} \mid 3 \leq i \leq D - 2 \text{ and } \Delta_i \neq 0\},$$

$$\ell = \max\{i \in \mathbb{N} \mid 3 \leq i \leq D - 1 \text{ and } \Delta_i \neq 0\}.$$

Results of Chapter 7 are as follows. We first show that  $\Delta_2 = 0$  implies  $D \leq 5$  or  $c_2 \in \{1, 2\}$ . In light of this result, it is natural to treat cases  $c_2 = 1$  and  $c_2 = 2$  separately. In this chapter we assume  $c_2 = 1$ . Furthermore, we assume  $\Gamma$  is not almost 2-homogeneous in the sense of Curtin [12], since these graphs are already well-understood. We describe the irreducible  $T$ -modules with endpoint 2 for this case. We show that up to isomorphism there exists exactly one irreducible  $T$ -module  $W$  with endpoint 2. The dimension of  $W$  depends on the number of scalars  $\Delta_i$  that are nonzero. Under our assumptions above, we give an orthogonal basis for  $W$  as follows. Pick nonzero  $v \in E_2^*W$  and let  $A_i$  ( $0 \leq i \leq D$ ) be the distance matrices of  $\Gamma$ . If either  $\ell \leq D - 2$ , or both  $\ell = D - 1$  and  $b_{D-1} = 1$ , then the following is a basis for  $W$ :

$$E_i^*A_{i-2}v \quad (2 \leq i \leq \ell), \quad E_i^*A_{i+2}v \quad (f \leq i \leq D - 2).$$

If  $\ell = D - 1$  and  $b_{D-1} \neq 1$ , then the following is a basis for  $W$ :

$$E_i^*A_{i-2}v \quad (2 \leq i \leq D), \quad E_i^*A_{i+2}v \quad (f \leq i \leq D - 2).$$

Furthermore, we give the action of the adjacency matrix on this basis in each case. We note that the Foster graph [3, Theorem 7.5.1] is an example of a bipartite distance-regular graph that is not  $Q$ -polynomial, but which meets our assumptions above. We know of no other examples. However, we remark that our basis for  $W$  is similar to Hobart and Ito's "ladder basis" for nonthin irreducible  $T$ -modules of endpoint 1 for distance-regular graphs with classical parameters [24].

Results of Chapter 8 are as follows. We show that up to isomorphism there exists exactly one irreducible  $T$ -module  $W$  with endpoint 2. The diameter of  $W$  is  $D - 4$  or  $D - 3$  (depends on the number of scalars  $\Delta_i$  that are nonzero). Under our assumptions above, we give a basis for  $W$  as follows. Pick nonzero  $v \in E_2^*W$  and let  $A_i$  ( $0 \leq i \leq D$ ) be the distance matrices of  $\Gamma$ . Then the following is a basis for  $W$ :

$$E_i^*A_{i-2}v \quad (2 \leq i \leq \ell), \quad E_i^*A_{i+2}v \quad (f \leq i \leq D - 2).$$

Furthermore, we give the action of the adjacency matrix on this basis. We note that the Double coset graph of the binary Golay code [3, Section 11.3E] is an example of a bipartite distance-regular graph that is not  $Q$ -polynomial, but which meets our assumptions above. We know of no other examples. Our irreducible  $T$ -module  $W$  with endpoint 2 is not thin and appears with multiplicity  $k_2 - k$  in the standard module. Note that this module is only a little larger than thin modules in the sense that its intersection with  $i$ th subconstituent has dimension 2 for  $f \leq i \leq \ell$  and dimension 1 for  $1 \leq i \leq f - 1$  and  $\ell + 1 \leq i \leq D - 1$ , if  $\ell = D - 1$  and  $\ell + 1 \leq i \leq D - 2$ , if  $\ell \leq D - 2$ .

Main results of Chapter 9 are Theorems 9.10 and 9.24. Let  $W$  denote irreducible  $T$ -module with endpoint 2 and pick  $v \in E_2^*W$ . In Theorem 9.10 we prove that a spanning set for  $W$  is

$$W = \text{span}\{v, E_3^*Av, \dots, E_D^*A_{D-2}v, E_2^*A_4v, E_3^*A_5v, \dots, E_{D-2}^*A_Dv\}$$

under assumption that (a.3) holds. In Theorem 9.24 we prove that (a.3) is equivalent with (a.10).

# Background: Adjacency and Bose-Mesner algebras

---

Let  $\Gamma = (X, \mathcal{R})$  denote a simple connected graph with  $d + 1$  distinct eigenvalues, diameter  $D$ , adjacency matrix  $A$ , distance- $i$  matrices  $\{A_i\}_{i=0}^D$  and let  $J$  denote all-1 matrix. The vector space  $\mathcal{A} = \mathcal{A}(\Gamma) = \{p(A) \mid p \in \mathbb{R}[x]\}$  is of dimension  $d + 1$  which is also an algebra for the ordinary product of matrices. The linear span of the set  $\{A_0, A_1, \dots, A_D\}$  forms an algebra  $\mathcal{D} = \mathcal{D}(\Gamma)$  with the elementwise Hadamard (Schur, componentwise, coefficientwise, entrywise) product of matrices known as the distance- $\circ$  algebra. In general case algebras  $\mathcal{A}$  and  $\mathcal{D}$  are different from the Bose-Mesner algebra  $\mathcal{M} = \mathcal{M}(\Gamma)$ , which is defined as algebra generated by  $\{A_0, A_1, \dots, A_D\}$  with respect to the ordinary matrix operation. In this chapter we overview some basic definition and results. For example, we overview how to compute orthogonal basis of primitive idempotents  $\{E_0, E_1, \dots, E_d\}$  of  $\mathcal{A}$  (orthogonal with respect to Hermitian form  $\langle R, S \rangle = |X|^{-1} \text{trace}(RS^{\top})$ ).

## 2.1 Basic definitions

In this section we review some definitions and basic results concerning linear algebra and algebraic graph theory.

Let  $\mathbb{F}$  denote the complex number or real number field and let  $X$  denote a nonempty finite set. Let  $\text{Mat}_X(\mathbb{F})$  denote the  $\mathbb{F}$ -algebra consisting of all matrices whose rows and columns are indexed by  $X$  and whose entries are in  $\mathbb{F}$ . Let  $\mathcal{V} = \mathbb{F}^X$  denote the vector space over  $\mathbb{F}$  consisting of column vectors whose coordinates are indexed by  $X$  and whose entries are in  $\mathbb{F}$ . We observe  $\text{Mat}_X(\mathbb{F})$  acts on  $\mathcal{V}$  by left multiplication. We call  $\mathcal{V}$  the *standard module*. We endow  $\mathcal{V}$  with the Hermitian inner product  $\langle \cdot, \cdot \rangle$  that satisfies  $\langle u, v \rangle = u^{\top} \bar{v}$  for  $u, v \in \mathcal{V}$ , where  $t$  denotes transpose and  $\bar{\cdot}$  denotes complex conjugation. Recall that

$$\langle u, Bv \rangle = \langle \bar{B}^{\top} u, v \rangle$$

for  $u, v \in \mathcal{V}$  and  $B \in \text{Mat}_X(\mathbb{F})$ . For  $y \in X$  let  $\hat{y}$  denote the element of  $\mathcal{V}$  with a 1 in the  $y$  coordinate and 0 in all other coordinates. We observe  $\{\hat{y} \mid y \in X\}$  is an orthonormal basis for  $\mathcal{V}$ .

A *graph*  $\Gamma$  is a pair  $(X, \mathcal{R})$ , where  $X = \{u, v, w, \dots\}$  is a nonempty set and  $\mathcal{R} = \{uv, wz, \dots\}$  is a collection of two element subsets of  $X$ . The elements of  $X$  are called the *vertices* of  $\Gamma$ , and the elements of  $\mathcal{R}$  are called the *edges* of  $\Gamma$ . When  $xy \in \mathcal{R}$ , we say that vertices  $x$  and  $y$  are *adjacent*, or that  $x$  and  $y$  are *neighbors*. Adjacency between vertices  $x$  and  $y$  will be denoted by  $x \sim y$ . A subset  $C \subseteq X$  is called a *clique* if every distinct  $x, y \in C$  are neighbors. A graph is *finite* if both its vertex set and edge set are finite. An edge with identical ends is called a *loop*, and a graph is *simple* if it has no loops and no two of its edges join the same pair of vertices.



Let  $\Gamma = (X, \mathcal{R})$  be a graph. For any two vertices  $x, y \in X$ , a *walk of length  $h$  from  $x$  to  $y$*  is a sequence  $[x_0, x_1, x_2, \dots, x_h]$  ( $x_i \in X$ ,  $0 \leq i \leq h$ ) such that  $x_0 = x$ ,  $x_h = y$ , and  $x_i$  is adjacent to  $x_{i+1}$  for all  $i$  ( $0 \leq i \leq h-1$ ). We say that  $\Gamma$  is *connected* if for any  $x, y \in X$ , there is a walk from  $x$  to  $y$ . From now on, assume that  $\Gamma$  is finite, simple and connected.

For any  $x, y \in X$ , the *distance* between  $x$  and  $y$ , denoted  $\partial(x, y)$ , is the length of the shortest walk from  $x$  to  $y$ . The *diameter*  $D = D(\Gamma)$  is defined on the following way

$$D = \max\{\partial(u, v) \mid u, v \in X\}. \quad (2.1)$$

A walk in  $\Gamma$  is said to be *closed* if it starts and ends at the same vertex.

Let  $\Gamma = (X, \mathcal{R})$  be a graph with diameter  $D$ . For a vertex  $x \in X$  and any non-negative integer  $h$  not exceeding  $D$ , let  $\Gamma_h(x)$  denote the subset of vertices in  $X$  that are at distance  $h$  from  $x$ . Put  $\Gamma_{-1}(x) = \Gamma_{D+1}(x) := \emptyset$ . For any two vertices  $x$  and  $y$  in  $X$  at distance  $h$ , let

$$\begin{aligned} C_h(x, y) &:= \Gamma_{h-1}(x) \cap \Gamma_1(y), \\ A_h(x, y) &:= \Gamma_h(x) \cap \Gamma_1(y) \quad \text{and} \\ B_h(x, y) &:= \Gamma_{h+1}(x) \cap \Gamma_1(y). \end{aligned}$$

We say  $\Gamma$  is *regular* with *valency*  $k$  if each vertex in  $\Gamma$  has exactly  $k$  neighbours. A graph  $\Gamma$  is called *distance-regular* if there are integers  $b_i, c_i$  ( $0 \leq i \leq D$ ) which satisfy  $c_i = |C_i(x, y)|$  and  $b_i = |B_i(x, y)|$  for any two vertices  $x$  and  $y$  in  $X$  at distance  $i$ . Clearly such a graph is regular of valency  $k := b_0$ . From this definition it is routine to show that  $\Gamma$  is distance-regular if and only if for all triples  $h, i, j$  ( $0 \leq h, j, i \leq D$ ), and for all  $x, y \in X$  with  $\partial(x, y) = h$ , the number  $|\Gamma_i(x) \cap \Gamma_j(y)|$  is independent of choice of  $x$  and  $y$ .

For  $0 \leq i \leq D$  let  $A_i$  denote the matrix in  $\text{Mat}_X(\mathbb{F})$  with  $(x, y)$ -entry

$$(A_i)_{xy} = \begin{cases} 1 & \text{if } \partial(x, y) = i, \\ 0 & \text{if } \partial(x, y) \neq i \end{cases} \quad (x, y \in X). \quad (2.2)$$

For notational convenience, we define  $A_i$  to be the zero matrix for all integers  $i < 0$  or  $i > D$ . We call  $A_i$  the *distance- $i$  matrix* of  $\Gamma$ . We abbreviate  $A := A_1$  and call this the *adjacency matrix* of  $\Gamma$ . We observe  $A_0 = I$ ;  $\sum_{i=0}^D A_i = J$ ;  $\overline{A_i} = A_i$  ( $0 \leq i \leq D$ ) and  $A_i^\top = A_i$  ( $0 \leq i \leq D$ ), where  $I$  (resp.  $J$ ) denotes the identity matrix (resp. all 1's matrix) in  $\text{Mat}_X(\mathbb{F})$ .

In order to present and relate all the results, we recall some basic results from algebraic graph theory (for more details, see e.g. [49]):

- (a.1) If  $\Gamma$  is a simple regular graph then  $k$  is an eigenvalue of  $\Gamma$  and for any eigenvalue  $\lambda$  of  $\Gamma$ ,  $|\lambda| \leq k$ . Moreover, if  $\Gamma$  is connected then the multiplicity of  $k$  is 1.
- (a.2) The number of walks of length  $\ell \geq 0$  between vertices  $u$  and  $v$  is  $(u, v)$ -entry of  $A^\ell$ .
- (a.3)  $\{I, A, A^2, \dots, A^D\}$  is linearly independent set.

We recall some basic definitions from linear algebra. Subspaces  $\mathcal{X}, \mathcal{Y}$  of a space  $\mathcal{W}$  are said to be *complementary* whenever  $\mathcal{W} = \mathcal{X} + \mathcal{Y}$  and  $\mathcal{X} \cap \mathcal{Y} = \{\mathbf{0}\}$ , in which case  $\mathcal{W}$  is said to be the *direct sum* of  $\mathcal{X}$  and  $\mathcal{Y}$ , and this is denoted by writing  $\mathcal{W} = \mathcal{X} + \mathcal{Y}$  (direct sum) or by  $\mathcal{W} = \mathcal{X} \oplus \mathcal{Y}$ . This is equivalent to saying that for each  $v \in \mathcal{W}$  there are unique vectors  $x \in \mathcal{X}$  and  $y \in \mathcal{Y}$  such that  $v = x + y$ . The vector  $x$  is called the *projection* of  $v$  onto  $\mathcal{X}$  along  $\mathcal{Y}$ . Vector  $y$  is called the projection of  $v$  onto  $\mathcal{Y}$  along  $\mathcal{X}$ . Operator  $P$  defined by  $Pv = x$  is unique linear operator with property  $Pv = x$  ( $v = x + y$ ,  $x \in \mathcal{X}$  and  $y \in \mathcal{Y}$ ) and is called the *projector* onto  $\mathcal{X}$  along  $\mathcal{Y}$ . Vector  $m$  is called the *orthogonal projection* of  $v$  onto  $\mathcal{M}$  if and only if  $v = m + n$  where  $\mathcal{M} \subseteq \mathcal{W}$  is subspace of  $\mathcal{W}$ ,  $m \in \mathcal{M}$  and  $n \in \mathcal{M}^\perp$ . The projector  $P_{\mathcal{M}}$  onto

$\mathcal{M}$  along  $\mathcal{M}^\perp$  is called the *orthogonal projector* onto  $\mathcal{M}$ . Let  $\mathcal{Z}$  denote a vector space and let  $\mathcal{L}(\mathcal{Z}, \mathcal{W})$  denote the space of all linear maps from the vector space  $\mathcal{Z}$  to the vector space  $\mathcal{W}$ . The *adjoint* of  $T \in \mathcal{L}(\mathcal{Z}, \mathcal{W})$  is the function  $T^* : \mathcal{W} \rightarrow \mathcal{Z}$  such that  $\langle Tv, w \rangle = \langle v, T^*w \rangle$  for every  $v \in \mathcal{Z}$  and every  $w \in \mathcal{W}$ . An operator  $T \in \mathcal{L}(\mathcal{Z})$  is called *self-adjoint* if  $T = T^*$ . An operator on an inner product space is called *normal* if it commutes with its adjoint.

A triple  $(\mathcal{V}, +, \cdot)$  is an *algebra* if and only if  $\mathcal{V}$  is a vector space over  $\mathbb{F}$ ,  $(\mathcal{V}, +, \cdot)$  is a ring and  $\alpha(uv) = (\alpha u)v = u(\alpha v)$  for every  $u, v \in \mathcal{V}$  and  $\alpha \in \mathbb{F}$ .

We recall three very important and well known claims (for more details, see e.g. [1]):

- (b.1) If  $\mathbb{F} = \mathbb{C}$  and  $T \in \mathcal{L}(\mathcal{V})$  then the following (i)–(iii) are equivalent: (i)  $T$  is normal; (ii)  $\mathcal{V}$  has an orthonormal basis consisting of eigenvectors of  $T$ ; (iii)  $T$  has a diagonal matrix with respect to some orthonormal basis of  $V$ .
- (b.2) If  $\mathbb{F} = \mathbb{R}$  and  $T \in \mathcal{L}(\mathcal{V})$  then the following (i)–(iii) are equivalent: (i)  $T$  is self-adjoint; (ii)  $\mathcal{V}$  has an orthonormal basis consisting of eigenvectors of  $T$ ; (iii)  $T$  has a diagonal matrix with respect to some orthonormal basis of  $V$ .

As immediate consequence of (b.1) and (b.2) we have:

- (c.1)  $\mathbb{F}^X$  has an orthonormal basis consisting of eigenvectors of  $A$ .

We recall the commutative association schemes. Let  $X$  be a finite set and  $\text{Mat}_X(\mathbb{F})$  the set of matrices over  $\mathbb{F}$  with rows and columns indexed by  $X$ . Let  $\mathcal{R} = \{R_0, R_1, \dots, R_n\}$  be a set of nonempty subsets of  $X \times X$ . For each  $i$ , let  $A_i \in \text{Mat}_X(\mathbb{F})$  be the adjacency matrix of the graph  $(X, R_i)$  (directed, in general). The pair  $(X, \mathcal{R})$  is an *association scheme*<sup>1</sup> with  $n$  classes if

(AS1)  $A_0 = I$ , the identity matrix;

(AS2)  $\sum_{i=0}^n A_i = J$ ;

(AS3)  $\bar{A}_i^\top \in \{A_0, A_1, \dots, A_n\}$  for  $0 \leq i \leq n$ ;

(AS4)  $A_i A_j$  is a linear combination of  $A_0, A_1, \dots, A_n$  for  $0 \leq i, j \leq n$ .

We say that  $(X, \mathcal{R})$  is *commutative* if algebra generated by the set  $\{A_0, A_1, \dots, A_n\}$  is commutative, and that  $(X, \mathcal{R})$  is *symmetric* if  $A_i$  are symmetric matrices. A symmetric association scheme is commutative. We recommend the survey articles [32, 15, 5] for more information.

We recall a coherent algebra on  $X$ . Let  $X$  be a finite set. A subalgebra  $\mathcal{F}$  of  $\text{Mat}_X(\mathbb{C})$  is *self-adjoint* if  $F \in \mathcal{F}$  implies  $F^* \in \mathcal{F}$  ( $F^*$  is the adjoint of  $F$ ). *Coherent algebra* on  $X$  is a self-adjoint subalgebra of  $(\text{Mat}_X(\mathbb{C}), +, \cdot)$  which is also a subalgebra of  $(\text{Mat}_X(\mathbb{C}), +, \circ)$ . Thus a subalgebra of  $\text{Mat}_X(\mathbb{C})$  is coherent if and only if it is closed under the adjoint map and elementwise Hadamard multiplication and contains the all 1 matrix  $J$ . For more background results see, for example, [23].

## 2.2 Primitive idempotents

In this section we study primitive idempotent of arbitrary simple connected graph  $\Gamma$ , which doesn't need to be regular.

Let  $\Gamma = (X, \mathcal{R})$  denote a simple graph with adjacency matrix  $A$  and with  $d + 1$  distinct eigenvalues  $\lambda_0 > \lambda_1 > \dots > \lambda_d$ . Since  $A$  is symmetric  $|X| \times |X|$  matrix,  $A$  has  $|X|$  distinct

<sup>1</sup>The notion coincides with that of homogeneous coherent configuration

eigenvectors  $\mathcal{U} = \{u_1, u_2, \dots, u_{|X|}\}$  which form orthonormal basis for  $\mathbb{F}^X$  (see (c.1)). Let  $V_i$  denote the eigenspace  $V_i = \ker(A - \lambda_i I)$  and let  $\dim(V_i) = m_i$ , for  $0 \leq i \leq d$ . For every vector  $u_i \in \mathcal{U}$  there exists exactly one eigenspace  $V_j$  such that  $u_i \in V_j$ , and since  $V_i \cap V_j = \{\mathbf{0}\}$  for  $i \neq j$ , we can divide set  $\mathcal{U}$  to sets  $\mathcal{U}_0, \mathcal{U}_1, \dots, \mathcal{U}_d$  such that

$$\mathcal{U}_i \text{ is a basis for } V_i, \quad \mathcal{U} = \mathcal{U}_0 \cup \mathcal{U}_1 \cup \dots \cup \mathcal{U}_d \quad \text{and} \quad \mathcal{U}_i \cap \mathcal{U}_j = \emptyset.$$

Note that

$$\mathbb{F}^X = V_1 \oplus V_2 \oplus \dots \oplus V_d$$

and

$$m_0 + m_1 + \dots + m_d = |X|. \quad (2.3)$$

**Definition 2.1 (primitive idempotents)** With the notation from above, for each eigenvalue  $\lambda_i$  ( $0 \leq i \leq d$ ) let  $U_i$  be the matrix whose columns form an orthonormal basis of its eigenspace  $V_i$ . The *primitive idempotents* of  $A$  are matrices

$$E_i := U_i U_i^\top \quad (0 \leq i \leq d).$$

**Lemma 2.2** *With reference to Definition 2.1,*

$$p(A) = \sum_{i=0}^d p(\lambda_i) E_i$$

for every polynomial  $p \in \mathbb{F}[t]$ .

PROOF. Pick  $i$  ( $0 \leq i \leq d$ ) and note that  $AU_i = \lambda_i AU_i$ . So, if  $P = [U_1|U_2|\dots|U_d]$  denote matrix which columns form orthonormal basis of eigenvectors of  $A$  we have

$$A = PGP^\top, \quad \text{where} \quad G = \begin{bmatrix} \lambda_0 I & 0 & \dots & 0 \\ 0 & \lambda_1 I & \dots & 0 \\ \vdots & \vdots & \dots & \vdots \\ 0 & 0 & \dots & \lambda_d I \end{bmatrix}$$

and  $\lambda_i I \in \text{Mat}_{m_i \times m_i}(\mathbb{F})$  ( $0 \leq i \leq d$ ). Now it is not hard to see that

$$\begin{aligned} p(A) &= Pp(G)P^{-1} = [U_0|U_1|\dots|U_d] \begin{bmatrix} p(\lambda_0)I & 0 & \dots & 0 \\ 0 & p(\lambda_1)I & \dots & 0 \\ \vdots & \vdots & \dots & \vdots \\ 0 & 0 & \dots & p(\lambda_d)I \end{bmatrix} \begin{bmatrix} U_0^\top \\ U_1^\top \\ \vdots \\ U_d^\top \end{bmatrix} \\ &= p(\lambda_0)U_0U_0^\top + p(\lambda_1)U_1U_1^\top + \dots + p(\lambda_d)U_dU_d^\top \\ &= p(\lambda_0)E_0 + p(\lambda_1)E_1 + \dots + p(\lambda_d)E_d. \end{aligned}$$

■

**Proposition 2.3** *With reference to Definition 2.1,*

$$\text{trace}(E_i) = m_i \quad (0 \leq i \leq d). \quad (2.4)$$

PROOF. It is not hard to see that  $\text{trace}(BC) = \text{trace}(CB)$  (for every matrices  $B$  and  $C$  of appropriate form), and thus

$$\text{trace}(E_i) = \text{trace}(U_i U_i^\top) = \text{trace}(U_i^\top U_i) = \text{trace}(I),$$

where  $I \in \text{Mat}_{m_i \times m_i}(\mathbb{F})$  is identity matrix. The result follows. ■

**Proposition 2.4** *With reference to Definition 2.1,*

$$E_i^\top = E_i \quad (0 \leq i \leq d), \quad (2.5)$$

$$\Gamma \text{ regular and connected} \quad \Rightarrow \quad E_0 = |X|^{-1}J \quad (J = \text{all 1's matrix}), \quad (2.6)$$

$$E_i E_j = \delta_{ij} E_i \quad (0 \leq i, j \leq D), \quad (2.7)$$

$$A E_i = \lambda_i E_i \quad (0 \leq i \leq d), \quad (2.8)$$

$$E_0 + E_1 + \dots + E_d = I, \quad (2.9)$$

$$\sum_{i=0}^d \lambda_i E_i = A, \quad (2.10)$$

$$E_i A = \lambda_i E_i \quad (0 \leq i \leq d). \quad (2.11)$$

PROOF. The relation (2.5) follows from the definition of  $E_i$ . Multiplicity of  $\lambda_0$  is 1 and if  $\Gamma$  is regular  $\mathbf{j} = (1, 1, \dots, 1)^\top$  is eigenvector corresponding to  $\lambda_0$  (see (a.1)). From this it follows that

$$E_0 = U_0 U_0^\top = \frac{\mathbf{j} \mathbf{j}^\top}{\|\mathbf{j}\| \|\mathbf{j}\|} = \frac{1}{\|\mathbf{j}\|^2} \begin{bmatrix} 1 \\ \vdots \\ 1 \end{bmatrix} [1 \quad \dots \quad 1] = \frac{1}{|X|} \begin{bmatrix} 1 & 1 & \dots & 1 \\ 1 & 1 & \dots & 1 \\ \vdots & \vdots & & \vdots \\ 1 & 1 & \dots & 1 \end{bmatrix}.$$

The product  $\begin{bmatrix} U_1^\top \\ U_2^\top \\ \vdots \\ U_d^\top \end{bmatrix} [U_1 | U_2 | \dots | U_d] = I$  yields  $U_i^\top U_j = \begin{cases} I & \text{if } i = j, \\ 0 & \text{otherwise.} \end{cases}$  Thus,

$$E_i E_j = U_i U_i^\top U_j U_j^\top = \begin{cases} U_i U_j^\top & \text{if } i = j \\ 0 & \text{if } i \neq j \end{cases} = \delta_{ij} E_i,$$

and (2.7) follows. To prove relation (2.8) note that

$$A E_i = A U_i U_i^\top = \lambda_i U_i U_i^\top = \lambda_i E_i.$$

Relations (2.9) and (2.10) follow from Lemma 2.2. Relation (2.11) follows from (2.7) and (2.10).  $\blacksquare$

**Proposition 2.5** *With reference to Definition 2.1,*

$$E_i = \frac{1}{\pi_i} \prod_{\substack{j=0 \\ j \neq i}}^d (A - \lambda_j I) \quad (0 \leq i \leq d),$$

where  $\pi_i = \prod_{j=0(j \neq i)}^d (\lambda_i - \lambda_j)$ .

PROOF. Pick  $i$  ( $0 \leq i \leq d$ ), and consider a polynomial  $g_i \in \mathbb{F}_d[t]$  defined as follows

$$g_i(t) = \frac{1}{\pi_i} \prod_{\substack{j=0 \\ j \neq i}}^d (t - \lambda_j).$$

Immediate from the definition of  $g_i$  we have

$$g_i(A) = \frac{1}{\pi_i} \prod_{\substack{j=0 \\ j \neq i}}^d (A - \lambda_j I).$$

On the other hand, by

$$g_i(t) = \begin{cases} 1, & \text{if } t = \lambda_i \\ 0, & \text{if } t \in \{\lambda_0, \lambda_1, \dots, \lambda_d\} \setminus \{\lambda_i\} \end{cases},$$

Lemma 2.2 yields

$$g_i(A) = g_i(\lambda_0)E_0 + g_i(\lambda_1)E_1 + \dots + g_i(\lambda_d)E_d = E_i.$$

The result follows. ■

**Corollary 2.6 (Hoffman polynomial)** ([25, Theorem 1]) *Let  $\Gamma = (X, \mathcal{R})$  denote a simple graph. There exists a polynomial  $h \in \mathbb{F}_d[t]$  such that  $J = h(A)$  if and only if  $\Gamma$  is regular and connected.*

PROOF. One direction follows immediate from (2.6) and Proposition 2.5. The other direction is trivial. ■

**Theorem 2.7** *Primitive idempotents of  $\Gamma$  represents the orthogonal projectors onto  $V_i = \ker(A - \lambda_i I)$  (along  $\text{im}(A - \lambda_i I)$ ).*

PROOF. Recall that for any  $B \in \text{Mat}_{m \times n}(\mathbb{F})$  we have

$$\dim \text{im}(B) + \dim \ker(B) = n,$$

$$\text{im}(B)^\perp = \ker(\overline{B}^\top), \quad \ker(B)^\perp = \text{im}(\overline{B}^\top).$$

For any subspace  $\mathcal{X}$  of a inner-product space  $\mathcal{V}$ , we have that  $\mathcal{V} = \mathcal{X} \oplus \mathcal{X}^\perp$ . This yields

$$\mathbb{F}^X = \text{im}(E_i) \oplus \ker(E_i).$$

It is only left to show that  $\text{im}(E_i) = \ker(A - \lambda_i I)$  and that  $\ker(E_i) = \text{im}(A - \lambda_i I)$ . To establish that  $\text{im}(E_i) = \ker(A - \lambda_i I)$ , use  $\text{im}(AB) \subseteq \text{im}(A)$  and  $U_i^\top U_i = I$  to find

$$\text{im}(E_i) = \text{im}(U_i U_i^\top) \subseteq \text{im}(U_i) = \text{im}(U_i U_i^\top U_i) = \text{im}(E_i U_i) \subseteq \text{im}(E_i).$$

Thus

$$\text{im}(E_i) = \text{im}(U_i) = \ker(A - \lambda_i I).$$

To show  $\ker(E_i) = \text{im}(A - \lambda_i I)$ , use  $A = \sum_{j=1}^d \lambda_j E_j$  with the already established properties of the  $E_i$ 's to conclude

$$E_i(A - \lambda_i I) = E_i \left( \sum_{j=1}^d \lambda_j E_j - \lambda_i \sum_{j=1}^d E_j \right) = \mathbf{O} \quad \Rightarrow \quad \text{im}(A - \lambda_i I) \subseteq \ker(E_i).$$

But we already know that  $\ker(A - \lambda_i I) = \text{im}(E_i)$ , so  $\dim \text{im}(A - \lambda_i I) = n - \dim \ker(A - \lambda_i I) = n - \dim \text{im}(E_i) = \dim \ker(E_i)$ , and therefore,

$$\text{im}(A - \lambda_i I) = \ker(E_i).$$

Thus,  $E_i$  is orthogonal projector onto  $V_i$  (along  $\text{im}(A - \lambda_i I)$ ). ■

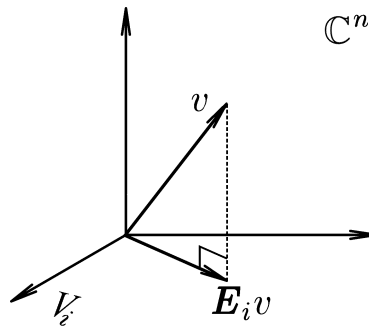

**Figure 2.1.**  $E_i$  projects on the  $\lambda_i$ -eigenspace  $V_i$ .

**Corollary 2.8** *With reference to Definition 2.1, let  $V = \mathbb{F}^X$  be the set of all  $|X|$ -dimensional column vectors (coordinates are indexed by  $X$ ). Then*

$$E_i V = \ker(A - \lambda_i I) \quad (0 \leq i \leq d)$$

and

$$V = E_0 V \oplus E_1 V \oplus \dots \oplus E_d V$$

(orthogonal direct sum of maximal  $A$ -eigenspaces).

PROOF. Routine. ■

### 2.3 Adjacency and Bose-Mesner algebras

In this section we continue to work with an arbitrary simple connected graph  $\Gamma$  (of diameter  $D$ ), which do not need to be regular. By our definition Bose-Mesner and adjacency algebras are in general two different spaces. Also, Bose-Mesner algebra defined our way does not have any connection with association schemes, so we do not need to assume that there exists an association scheme.

**Definition 2.9** Let  $A$  denote adjacency matrix of a simple connected graph  $\Gamma = (X, \mathcal{R})$ . The *adjacency algebra* of a graph  $\Gamma$  is subalgebra  $\mathcal{A} = \mathcal{A}(\Gamma) = (\langle A \rangle, +, \cdot) = \{p(A) : p \in \mathbb{R}[x]\}$  of  $(\text{Mat}_X(\mathbb{F}), +, \cdot)$  generated by  $A$  under the usual matrix operations. The subalgebra

$$\begin{aligned} \mathcal{M} = \mathcal{M}(\Gamma) &= (\langle I, A, \dots, A_D \rangle, +, \cdot) \\ &\supseteq \{p_0(I) + p_1(A) + \dots + p_D(A_D) \mid p_0, p_1, \dots, p_D \in \mathbb{F}[t]\} \end{aligned}$$

of  $(\text{Mat}_X(\mathbb{F}), +, \cdot)$  generated by the set of distance- $i$  matrices  $\{A_0, A_1, \dots, A_D\}$  under the usual matrix operations, we call the *Bose-Mesner algebra* of  $\Gamma$ . Note that  $\mathcal{A} \subseteq \mathcal{M}$ .

By our definition, the Bose-Mesner algebra is the adjacency algebra form theory of coherent configuration. A configuration  $(X, \{f_i\}_{i \in I})$  on  $X$  over a set  $I$  consists of a nonempty set  $X$  together with a family  $\{f_i\}_{i \in I}$  of nonempty binary relations on  $X$ . A configuration in this sense can be identified with its family  $\{\Gamma_i\}_{i \in I}$  of graphs  $\Gamma_i = (X, f_i)$ , or with the family  $\{A_i\}_{i \in I}$  of matrices of the  $f_i$ , which are the adjacency matrices of the configuration. For more background information see [23, 22].

**Proposition 2.10** *With reference to Definition 2.1, each power of  $A$  can be expressed as a linear combination of the idempotents  $E_i$  ( $0 \leq i \leq d$ ), that is,*

$$A^h = \sum_{i=0}^d \lambda_i^h E_i \quad (h \in \mathbb{N}).$$

PROOF. By Lemma 2.2,  $p(A) = \sum_{i=0}^d p(\lambda_i)E_i$  for every polynomial  $p \in \mathbb{F}[t]$ . If for polynomial  $p$  we pick  $p \in \{1, t, t^2, \dots, t^h, \dots\}$ , the result follows. ■

**Corollary 2.11** *If a simple graph  $\Gamma$  has  $d + 1$  distinct eigenvalues, then  $\{E_0, E_1, \dots, E_d\}$  is an orthogonal basis of the adjacency algebra  $\mathcal{A} = (\langle A \rangle, +, \cdot)$ .*

PROOF. Since (2.4) hold,  $E_i$  are not zero matrices. By Proposition 2.10 we have that  $\mathcal{A} = \text{span}\{E_0, E_1, \dots, E_d\}$ . Relation (2.7) yields that the set  $\{E_0, E_1, \dots, E_d\}$  is linearly independent. The result follows. ■

**Proposition 2.12** *If a simple graph  $\Gamma$  has  $d + 1$  distinct eigenvalues, then  $\{I, A, A^2, \dots, A^d\}$  is a basis of the adjacency algebra  $\mathcal{A} = (\langle A \rangle, +, \cdot)$ .*

PROOF. We want to prove that the set  $\{I, A, \dots, A^d\}$  is linearly independent. We show that the system

$$\alpha_0 I + \alpha_1 A + \dots + \alpha_d A^d = 0$$

has only one solution  $\alpha_0 = \alpha_1 = \dots = \alpha_d = 0$ . By Proposition 2.10, we have

$$\begin{aligned} I &= E_0 + E_1 + \dots + E_d, \\ A &= \lambda_0 E_0 + \lambda_1 E_1 + \dots + \lambda_d E_d, \\ &\dots \\ A^d &= \lambda_0^d E_0 + \lambda_1^d E_1 + \dots + \lambda_d^d E_d, \end{aligned}$$

that is

$$\begin{aligned} \alpha_0 I &= \alpha_0 (E_0 + E_1 + \dots + E_d), \\ \alpha_1 A &= \alpha_1 (\lambda_0 E_0 + \lambda_1 E_1 + \dots + \lambda_d E_d), \\ &\dots \\ \alpha_d A^d &= \alpha_d (\lambda_0^d E_0 + \lambda_1^d E_1 + \dots + \lambda_d^d E_d). \end{aligned}$$

This yield

$$\beta_0 E_0 + \beta_1 E_1 + \dots + \beta_d E_d = 0$$

where

$$\beta_i = \alpha_0 + \alpha_1 \lambda_i + \dots + \alpha_d \lambda_i^d \quad (0 \leq i \leq d).$$

Since the set  $\{E_0, E_1, \dots, E_d\}$  is linearly independent, we can conclude that  $\beta_0 = \beta_1 = \dots = \beta_d = 0$ . If we consider connection between numbers  $\alpha_i$  and  $\beta_i$  we have

$$\underbrace{\begin{bmatrix} 1 & \lambda_0 & \lambda_0^2 & \dots & \lambda_0^d \\ 1 & \lambda_1 & \lambda_1^2 & \dots & \lambda_1^d \\ 1 & \lambda_2 & \lambda_2^2 & \dots & \lambda_2^d \\ \vdots & \vdots & \vdots & & \vdots \\ 1 & \lambda_d & \lambda_d^2 & \dots & \lambda_d^d \end{bmatrix}}_{=B} \begin{bmatrix} \alpha_0 \\ \alpha_1 \\ \alpha_2 \\ \vdots \\ \alpha_d \end{bmatrix} = \begin{bmatrix} \beta_0 \\ \beta_1 \\ \beta_2 \\ \vdots \\ \beta_d \end{bmatrix} = \begin{bmatrix} 0 \\ 0 \\ 0 \\ \vdots \\ 0 \end{bmatrix}.$$

Since  $B$  is actually a Vandermonde matrix (see, for example, [33, page 185]), above system has unique solution, and  $\alpha_0 = \alpha_1 = \dots = \alpha_d = 0$ . Thus  $\{I, A, \dots, A^d\}$  is a linearly independent set.

In the end, for example, note that

$$\begin{bmatrix} I \\ A \\ A^2 \\ \vdots \\ A^d \end{bmatrix} = \underbrace{\begin{bmatrix} 1 & 1 & \dots & 1 \\ \lambda_0 & \lambda_1 & \dots & \lambda_d \\ \lambda_0^2 & \lambda_1^2 & \dots & \lambda_d^2 \\ \vdots & \vdots & & \vdots \\ \lambda_0^d & \lambda_1^d & \dots & \lambda_d^d \end{bmatrix}}_{=B^\top} \begin{bmatrix} E_0 \\ E_1 \\ E_2 \\ \vdots \\ E_d \end{bmatrix}.$$

The result follows. ■

**Corollary 2.13** *In a simple connected graph  $\Gamma$  with  $d + 1$  distinct eigenvalues and diameter  $D$ , the diameter is always less than the number of distinct eigenvalues:  $D \leq d$ .*

PROOF. By (a.3),  $\{I, A, A^2, \dots, A^D\}$  is a linearly independent set. Proposition 2.12 yield that  $\{I, A, A^2, \dots, A^d\}$  is maximal linearly independent set. The result follows. ■

**Corollary 2.14** *Let  $\Gamma = (X, \mathcal{R})$  denote a simple graph with  $d + 1$  distinct eigenvalues. The number of closed walks starting at  $x$ , of length  $\ell \geq 0$  is the same for any  $x \in X$  if and only if the diagonal entries in  $E_i$  are all equal, for any  $i$  ( $1 \leq i \leq d$ ).*

PROOF. Recall that the number of walks of length  $\ell \geq 0$  in  $\Gamma$ , joining  $u$  to  $v$  is the  $(u, v)$ -entry of the matrix  $A^\ell$  (see (a.2)). The result now follows immediate from Corollary 2.11 and Proposition 2.12. ■

If  $P_3$  is the path graph on three vertices, then diagonal entries of  $E_i$  for  $P_3 \times P_3$  have at most three different values, for any  $i$  ( $1 \leq i \leq 4$ ) (see [42, Example 11.3]).

**Corollary 2.15** ([18, Characterizations D and E]) *Let  $\Gamma = (X, \mathcal{R})$  denote a simple graph with  $d + 1$  distinct eigenvalues. For each non-negative integer  $\ell$ , the number of walks of length  $\ell$  between vertices  $u, v \in X$  only depends on  $h = \partial(u, v)$  if and only if for every  $0 \leq i \leq d$  and for every pair of vertices  $(u, v)$  of  $\Gamma$ , the  $(u, v)$ -entry of  $E_i$  depends only on the distance between  $u$  and  $v$ .*

PROOF. Similar to the proof of Corollary 2.14. ■

**Remark 2.16** Graphs  $\Gamma$  which satisfy conditions from Corollary 2.14 are known as walk-regular graphs. A distance-regular graph  $\Gamma$  satisfy both conditions from Corollary 2.15, and vice versa.

**Lemma 2.17** *With reference to Definition 2.9, let  $\Gamma$  denote a simple graph with  $d + 1$  distinct eigenvalues. Then the following (i)–(iv) hold.*

- (i) *If  $\dim(\mathcal{M}) = D + 1$  then  $d = D$  and  $\mathcal{M} = \mathcal{A}$ .*
- (ii) *If  $\dim(\mathcal{M}) = d + 1$  then  $\mathcal{M} = \mathcal{A}$ .*
- (iii) *If  $A_i \in \mathcal{A}$  for all  $i$  ( $0 \leq i \leq D$ ) then  $\mathcal{M} = \mathcal{A}$ .*
- (iv) *If  $\Gamma$  is a regular connected graph of diameter 2 then  $\mathcal{M} = \mathcal{A}$ .*

PROOF. Routine. ■

**Lemma 2.18** *With reference to Definition 2.9, if  $A_i \in \mathcal{A}$  for some  $i$  ( $0 \leq i \leq D$ ) then  $|\Gamma_i(x)|$  does not depend on  $x \in X$ .*

PROOF. If  $A_i = p(A)$  for some  $p \in \mathbb{R}[t]$  then  $A_i \mathbf{j} = p(\lambda_0) \mathbf{j}$ . The result follows. ■

**Research problem 2.19** *Pick  $i$  ( $0 \leq i \leq D$ ). Find under which combinatorial conditions of  $\Gamma$  we have that  $A_i \in \mathcal{A} = (\langle A \rangle, +, \cdot)$ .*



## 2.4 Inner products on $\text{Mat}_X(\mathbb{F})$ and $\mathbb{F}_d[x]$

For a nonempty finite set  $X$  let  $\text{Mat}_X(\mathbb{F})$  denote the  $\mathbb{F}$ -algebra consisting of the matrices whose rows and columns are indexed by  $X$  and whose entries are in  $\mathbb{F}$ . For  $C \in \text{Mat}_X(\mathbb{F})$  let  $\overline{C}$ ,  $C^\top$ ,  $\overline{C}^\top$  and  $\text{trace}(C)$  denote the complex conjugate, the transpose, the conjugate transpose and the trace of  $C$ , respectively.

**Lemma 2.20** *Let  $X$  be a finite nonempty set. For  $B, C \in \text{Mat}_X(\mathbb{F})$  put*

$$\langle B, C \rangle = \frac{1}{|X|} \text{trace}(B\overline{C}^\top) \quad (2.12)$$

and

$$\|C\|^2 = \langle C, C \rangle.$$

Then for all  $B, B', C \in \text{Mat}_X(\mathbb{F})$  and  $\alpha \in \mathbb{F}$  the following (i)–(v) hold.

- (i)  $\langle \alpha B, C \rangle = \alpha \langle B, C \rangle$  (homogeneity in first slot).
- (ii)  $\langle B, C \rangle = \overline{\langle C, B \rangle}$  (conjugate symmetry).
- (iii)  $\langle B + B', C \rangle = \langle B, C \rangle + \langle B', C \rangle$  (additivity in first slot).
- (iv)  $\|B\|^2$  is nonnegative real number (positivity).
- (v)  $\|B\|^2 = 0$  if and only if  $B = 0$  (definiteness).

In other words  $\langle \star, \star \rangle$  is an inner product on  $\text{Mat}_X(\mathbb{F})$ .

PROOF. Routine. ■

Inner product on  $\text{Mat}_X(\mathbb{F})$  from Lemma 2.20 can be also defined as follows. For any  $R, S \in \text{Mat}_X(\mathbb{F})$

$$\langle R, S \rangle = \frac{1}{|X|} \sum_{u \in X} (R\overline{S}^\top)_{uu} = \frac{1}{|X|} \sum_{u \in X} \sum_{v \in X} (R)_{uv} (\overline{S})_{uv} = \frac{1}{|X|} \sum_{u, v \in X} (R \circ \overline{S})_{uv}. \quad (2.13)$$

**Lemma 2.21** *With reference to Lemma 2.20,*

$$\langle AB, C \rangle = \langle B, \overline{A}^\top C \rangle = \langle A, \overline{C} B^\top \rangle.$$

PROOF. Routine using  $\text{trace}(AB) = \text{trace}(BA)$  for any  $A, B \in \text{Mat}_X(\mathbb{F})$ . ■

Consider the vector space  $\mathbb{F}_d[t] = \{a_0 + a_1t + \dots + a_d t^d \mid a_0, a_1, \dots, a_d \in \mathbb{F}\}$  of all polynomials of degree at most  $d$ . The following questions immediately appear:

- (1) How to define multiplication on  $\mathbb{F}_d[t]$  so that  $(\mathbb{F}_d[t], +, \cdot)$  is a ring?
- (2) For a such operation of multiplication from (1) is it possible to find a map  $T$ , so that  $T$  is an isomorphism between rings  $(\mathbb{F}_d[t], +, \cdot)$  and  $(\mathcal{A}, +, \cdot)$ ? Is such an isomorphism  $T$  important at all?
- (3) How to define inner product on  $\mathbb{F}_d[t]$ , so that there exists some map  $T : \mathbb{F}_d[t] \rightarrow \mathcal{A}$ , which is an isometry of a vector spaces, that is, so that  $\|Tp\| = \|p\|$  for any  $p \in \mathbb{F}_d[t]$ ?

The answer to the first question from above is very well known. Let  $z(t) := \prod_{i=0}^d (t - \lambda_i)$ . In a vector space  $\mathbb{F}_d[t]$  we can define polynomial multiplication modulo  $z(t)$  and obtain that  $(\mathbb{F}_d[t], +, \cdot)$  is an algebra. This algebra is isomorphic to  $(\mathbb{F}[t]/(z), +, \cdot)$ , where  $(z) = \mathbb{F}[t] \cdot z = \{pz \mid p \in \mathbb{F}[t]\}$  is an ideal in  $\mathbb{F}[t]$  (note that  $(z)$  is a set of all polynomials of degree  $\geq d + 1$ ). An answer to the first part of the second question we do not know, and in our case we do not need it. What is very important for our case is an answer to the third question. We give this answer in Proposition 2.23.

**Example 2.22** For a given graph  $\Gamma$ , with  $d + 1$  eigenvalues  $\lambda_0 > \lambda_1 > \dots > \lambda_d$ , and the notation from above, let  $h = h(t) = \frac{|X|}{\pi_0} \prod_{i=1}^d (t - \lambda_i)$  denote the Hoffman polynomial, where  $\pi_0 = \prod_{i=1}^d (\lambda_0 - \lambda_i)$ . We want to calculate  $t \cdot h(t)$  in space  $\mathbb{F}_d[t]$ . Since  $h(t - \lambda_0) = \frac{|X|}{\pi_0} z$  we have that  $h(t - \lambda_0) = 0$  in  $\mathbb{F}_d[t]$ , and with that  $t \cdot h = \lambda_0 h$ .

**Proposition 2.23** ([4, Section 2], [19, Section 3]) *Let  $\Gamma = (X, \mathcal{R})$  denote a simple graph with adjacency matrix  $A$  and  $d + 1$  distinct eigenvalues  $\lambda_0 > \lambda_1 > \dots > \lambda_d$ . Let  $z = z(t) = \prod_{i=0}^d (t - \lambda_i)$  and let  $\mathbb{F}_d[t] = \{a_0 + a_1 t + \dots + a_d t^d \mid a_i \in \mathbb{F}, 0 \leq i \leq d\}$  be a set of all polynomials of degree at most  $d$  with coefficients from  $\mathbb{F}$ . For every  $p, q \in \mathbb{F}_d[t]$  we define*

$$\langle p, q \rangle = \frac{1}{|X|} \text{trace}(p(A) \overline{q(A)}^\top),$$

and

$$\|p\|^2 = \langle p, p \rangle.$$

Then the following (i), (ii) hold.

- (i)  $\langle \cdot, \cdot \rangle$  is a inner product in  $\mathbb{F}_d[x]$ .
- (ii) The map  $T : \mathbb{F}_d[t] \rightarrow \mathcal{A}$  defined with

$$T(a_0 + a_1 t + \dots + a_d t^d) = a_0 I + a_1 A + \dots + a_d A^d$$

is an isomorphism of vector spaces  $\mathbb{F}_d[t]$  and  $\mathcal{A}$ . Moreover,  $T$  is an isometry, that is,

$$\|Tp\| = \|p\| \quad \forall p \in \mathbb{F}_d[t].$$

PROOF. (i) Since  $p(A), q(A) \in \text{Mat}_X(\mathbb{F})$ , the result follows immediate from Lemma 2.20.

(ii) It is easy to see that  $T$  is isomorphism of vector spaces. On the other hand, we have

$$\|Tp\|^2 = \langle Tp, Tp \rangle = \langle p(A), p(A) \rangle = \frac{1}{|X|} \text{trace}(p(A) \overline{p(A)}^\top) = \|p\|^2.$$

The result follows. ■

**Proposition 2.24** *With reference to Proposition 2.23, let*

$$\text{spec}(\Gamma) = \{\lambda_0^{m(\lambda_0)}, \lambda_1^{m(\lambda_1)}, \dots, \lambda_d^{m(\lambda_d)}\}.$$

Then for any  $p, q \in \mathbb{F}_d[t]$

$$\langle p, q \rangle = \frac{1}{|X|} \sum_{i=0}^d m_i p(\lambda_i) q(\lambda_i) \tag{2.14}$$

where  $m_i = m(\lambda_i)$  ( $0 \leq i \leq d$ ).

PROOF. With the notation from the proof of Lemma 2.2, for any  $p \in \mathbb{F}_d[t]$  we have  $A = PGP^\top$  and  $p(A) = Pp(G)P^t$ . Thus

$$\langle p, q \rangle = \frac{1}{|X|} \text{trace}(Pp(G)q(G)P^\top) = \frac{1}{|X|} \text{trace}(p(G)q(G)) = \frac{1}{|X|} \sum_{i=0}^d m(\lambda_i) p(\lambda_i) q(\lambda_i).$$

■

**Lemma 2.25** *With reference to Proposition 2.23, let  $\{q_0, q_1, \dots, q_d\}$  denote the set of orthogonal polynomials from  $\mathbb{F}_d[t]$  such that  $\text{dgr}(q_i) = i$  ( $0 \leq i \leq d$ ). Then the following (i)–(iv) hold.*

- (i) Every  $q_h$  ( $0 \leq h \leq d$ ) is orthogonal to arbitrary polynomial of lower degree.
- (ii)  $\langle tq_i, q_j \rangle = \langle q_i, tq_j \rangle$ .
- (iii) If  $|i - j| > 1$  then  $\langle tq_i, q_j \rangle = \langle q_i, tq_j \rangle = 0$ .
- (iv) There exists numbers  $a_i^{(q)}, b_i^{(q)}, c_i^{(q)} \in \mathbb{F}$  ( $0 \leq i \leq d$ ) such that

$$\begin{aligned} tq_0 &= a_0^{(q)} q_0 + c_1^{(q)} q_1, \\ tq_i &= b_{i-1}^{(q)} q_{i-1} + a_i^{(q)} q_i + c_{i+1}^{(q)} q_{i+1} \quad (1 \leq i \leq d-1), \\ tq_d &= b_{d-1}^{(q)} q_{d-1} + a_d^{(q)} q_d. \end{aligned}$$

PROOF. (i) By the definition  $\{q_0, q_1, \dots, q_d\}$  is an orthogonal set of polynomials such that  $\text{dgr}(q_i) = i$  ( $0 \leq i \leq d$ ). So for any polynomial  $p$  of degree  $i$  ( $0 \leq i \leq d$ ) we have  $p \in \text{span}\{q_0, q_1, \dots, q_i\}$ , and this yield that if  $h > i$  then  $\langle p, q_h \rangle = 0$ .

- (ii) Immediate from (2.14).
- (iii) Immediate from (i) and (ii).
- (iv) Pick  $h$  ( $1 \leq h \leq d-1$ ). By (iii), we have

$$\begin{aligned} tq_h &= \sum_{i=0}^d \frac{\langle tq_h, q_i \rangle}{\|q_i\|^2} q_i = \sum_{i=0}^d \frac{\langle q_h, tq_i \rangle}{\|q_i\|^2} q_i \\ &= \underbrace{\frac{\langle q_h, tq_{h-1} \rangle}{\|q_{h-1}\|^2}}_{b_{h-1}^{(q)}} q_{h-1} + \underbrace{\frac{\langle q_h, tq_h \rangle}{\|q_h\|^2}}_{a_h^{(q)}} q_h + \underbrace{\frac{\langle q_h, tq_{h+1} \rangle}{\|q_{h+1}\|^2}}_{c_{h+1}^{(q)}} q_{h+1}, \end{aligned}$$

and the second equality follows. Similarly for the first and the third one. ■

**Lemma 2.26** ([4, Proposition 2.6], [19, Section 2], [20]) *With reference to Proposition 2.23, let  $\{p_0, p_1, \dots, p_d\}$  be a set of orthogonal polynomials in  $\mathbb{F}_d[t]$  such that  $\text{dgr}(p_i) = i$ ,  $0 \leq i \leq d$ . Then the following (i)–(iii) are all equivalent.*

- (i)  $\|p_i\|^2 = p_i(\lambda_0)$  ( $0 \leq i \leq d$ ).
- (ii)  $p_0 + p_1 + \dots + p_d = \frac{|X|}{\pi_0} \prod_{i=1}^d (t - \lambda_i)$ , where  $\pi_0 = \prod_{h=1}^d (\lambda_0 - \lambda_h)$ .
- (iii)  $p_0 = 1$ ,  $a_0 + b_0 = \lambda_0$ ,  $a_i + b_i + c_i = \lambda_0$  ( $1 \leq i \leq d-1$ ) and  $a_d + c_d = \lambda_0$ , where  $a_i, b_i, c_i$  ( $0 \leq i \leq d$ ) are numbers such that

$$\begin{aligned} tp_0 &= a_0 p_0 + c_1 p_1, \\ tp_i &= b_{i-1} p_{i-1} + a_i p_i + c_{i+1} p_{i+1} \quad (1 \leq i \leq d-1), \\ tp_d &= b_{d-1} p_{d-1} + a_d p_d. \end{aligned}$$

We note that  $\frac{|X|}{\pi_0} \prod_{i=0}^d (t - \lambda_i)$  is the Hoffman polynomial  $h = h(t)$  from the Corollary 2.6.

PROOF. Let  $h = h(t) := \frac{|X|}{\pi_0} \prod_{i=1}^d (t - \lambda_i)$  denote the Hoffman polynomial, and note that  $h(\lambda_0) = |X|$ ,  $h(t) = 0$  for  $t \in \{\lambda_1, \lambda_2, \dots, \lambda_d\}$ .

We will show that (i)  $\Rightarrow$  (ii)  $\Rightarrow$  (iii)  $\Rightarrow$  (i).

(i) $\Rightarrow$ (ii). The Fourier expansion of  $h$  is

$$h = \frac{\langle h, p_0 \rangle}{\|p_0\|^2} p_0 + \frac{\langle h, p_1 \rangle}{\|p_1\|^2} p_1 + \dots + \frac{\langle h, p_d \rangle}{\|p_d\|^2} p_d \quad (2.15)$$

On the other hand,

$$\langle h, p_j \rangle = \frac{1}{|X|} \sum_{i=0}^d m_i h(\lambda_i) p_j(\lambda_i) = p_j(\lambda_0) = \|p_j\|^2 \quad (0 \leq j \leq d). \quad (2.16)$$

By (2.15) and (2.16), the result follows.

(ii) $\Rightarrow$ (iii). Using the fact that  $\|p_0\|^2 = p_0(\lambda_0)$  and  $\text{dgr}(p_0) = 0$ , it is not hard to see that  $p_0 = 1$ . By Lemma 2.25(iv), there exist numbers  $a_i, b_i, c_i$  ( $0 \leq i \leq d$ ) such that Lemma 2.25(iv) hold, and with that

$$t \cdot h = \sum_{i=0}^d t p_i = (a_0 + b_0) p_0 + \sum_{i=0}^{d-1} (a_i + b_i + c_i) p_i + (c_d + a_d) p_d.$$

On the other hand  $xh = \lambda_0 h = \sum_{i=0}^d \lambda_0 p_i$ . The result follows.

(iii) $\Rightarrow$ (i). Since  $\sum_{i=0}^d x p_i = \sum_{i=0}^d (a_i + b_i + c_i) p_i = \sum_{i=0}^d \lambda_0 p_i$  we have

$$(x - \lambda_0) \sum_{i=0}^d p_i = 0 = (x - \lambda_0) h$$

in  $\mathbb{F}_d[x]$ . This yield  $\sum_{i=0}^d p_i = h$ . Now, for any  $j$  ( $0 \leq j \leq d$ ) we have

$$\|p_j\|^2 = \langle p_j, \underbrace{p_0 + p_1 + \dots + p_d}_{=h} \rangle = p_j(\lambda_0).$$

The result follows. ■

Note that, if  $\Gamma$  is regular then Lemma 2.26(iii) yields  $a_i + b_i + c_i = k$ .

**Definition 2.27 (predistance polynomials)** *Orthogonal set of polynomials  $\{p_0, p_1, \dots, p_d\}$  ( $\text{dgr}(p_i) = i$ ,  $0 \leq i \leq d$ ) in  $\mathbb{F}_d[t]$  which satisfies conditions (i)–(iii) of Lemma 2.26 are called predistance polynomials.*

## 2.5 Krein parameters $q_{ij}^h$

In this section we study adjacency algebra  $\mathcal{A} = \mathcal{A}(\Gamma)$  under additional assumption that the vector space  $\text{span}\{E_0, E_1, \dots, E_d\}$  is closed under elementwise Hadamard multiplication  $B \circ C$  of matrices.

**Definition 2.28** Let  $\Gamma = (X, \mathcal{R})$  denote a simple connected graph for which the vector space  $\text{span}\{E_0, E_1, \dots, E_d\}$  is closed under elementwise Hadamard multiplication  $B \circ C$  of matrices. Then there exist real numbers  $q_{ij}^h$  such that

$$E_i \circ E_j = \frac{1}{|X|} \sum_{h=0}^d q_{ij}^h E_h \quad (0 \leq i, j \leq d). \quad (2.17)$$

The numbers  $q_{ij}^h$  are called the *Krein parameters* for  $\Gamma$  with respect to the ordering  $E_0, E_1, \dots, E_d$  of the primitive idempotents.

By definition, it is obvious that

$$q_{ij}^h = q_{ji}^h \quad (0 \leq i, j, h \leq d). \quad (2.18)$$

Following J. J. SEIDEL [44], let us define  $\sum(B) := \sum_{x,y \in X} (B)_{xy}$ , the sum of all entries of a matrix  $B \in \text{Mat}_X(\mathbb{F})$ . Then

$$\sum(M \circ N) = \text{trace}(MN^\top) \quad (2.19)$$

and

$$JBJ = \sum(B)J. \quad (2.20)$$

**Theorem 2.29** ([39, proof of Theorem 1.1]) *With respect to Definition 2.28, let  $\sum(B)$  denote the sum of all entries of the matrix  $B$ . Then for all  $i, j, h \in \{0, 1, \dots, d\}$*

$$q_{ij}^h = \frac{|X|}{m_h} \sum (E_i \circ E_j \circ E_h). \quad (2.21)$$

Moreover

$$q_{ij}^h \geq 0, \quad (2.22)$$

with equality if and only if

$$\sum_{x \in X} (E_i)_{ux} (E_j)_{vx} (E_h)_{wx} = 0 \quad \text{for all } u, v, w \in X. \quad (2.23)$$

PROOF. Since the  $E_i$  are symmetric idempotent matrices

$$(E_i)_{xy} = \sum_{u \in X} (E_i)_{ux} (E_i)_{uy}.$$

Hence, if we denote the left hand side of (2.23) by  $q_{uvw}$ , we have

$$\begin{aligned} \sum (E_i \circ E_j \circ E_h) &= \sum_{x,y \in X} (E_i)_{xy} (E_j)_{xy} (E_h)_{xy} \\ &= \sum_{x,y \in X} \left( \left( \sum_{u \in X} (E_i)_{ux} (E_i)_{uy} \right) \left( \sum_{v \in X} (E_j)_{vx} (E_j)_{vy} \right) \left( \sum_{w \in X} (E_h)_{wx} (E_h)_{wy} \right) \right) \\ &= \sum_{u,v,w \in X} \left( \left( \sum_{x \in X} (E_i)_{ux} (E_j)_{vx} (E_h)_{wx} \right) \cdot \left( \sum_{y \in X} (E_i)_{uy} (E_j)_{vy} (E_h)_{wy} \right) \right) = \sum_{u,v,w \in X} q_{uvw}^2. \end{aligned}$$

Since we also have

$$|X| \sum (E_i \circ E_j \circ E_h) = |X| \text{trace}((E_i \circ E_j)E_h) = \text{trace} \left( \sum_{\ell=0}^d q_{ij}^\ell E_\ell E_h \right) = m_h q_{ij}^h,$$

inequality (2.22) holds. Note that equality in (2.22) holds if and only if  $\sum_{u,v,w \in X} q_{uvw}^2 = 0$ , which is equivalent to (2.23).  $\blacksquare$

The inequalities (2.22) are referred to as the Krein conditions. When  $q_{ij}^h = 0$  for some  $h, i, j$  equality (2.23) has also a combinatorial meaning for the structure of a given graph (see [7, Theorem 3] in case when  $\Gamma$  is a distance-regular graph).

**Remark 2.30** Assume that for a graph  $\Gamma$ , we have that subalgebra  $\text{span}\{E_0, E_1, \dots, E_d\}$  of  $(\text{Mat}_X(\mathbb{F}), +, \circ)$  is of dimension  $d+1$ . From adjacency matrix we can compute the eigenvalues and then we can use Proposition 2.5 to compute primitive idempotents  $E_i$  ( $0 \leq i \leq d$ ). Multiplicities of eigenvalues can be obtained using Proposition 2.4. Now (2.21) can be used to compute Krein parameters  $q_{ij}^h$ .

**Lemma 2.31** *With reference to Definition 2.28, let  $m_i$  denote the multiplicity of  $\lambda_i$ , that is,  $m_i := m(\lambda_i) = \dim(V_i)$ . If the graph  $\Gamma$  is regular then*

$$q_{0j}^h = \delta_{hj} \quad (0 \leq j, h \leq d), \quad (2.24)$$

$$q_{i0}^h = \delta_{ih} \quad (0 \leq i, h \leq d), \quad (2.25)$$

$$q_{ij}^0 = \delta_{ij} m_i \quad (0 \leq i, j \leq d), \quad (2.26)$$

$$q_{ij}^h m_h = q_{ih}^j m_j = q_{jh}^i m_i, \quad (2.27)$$

$$\sum_{\ell=0}^d q_{ij}^\ell q_{\ell h}^m = \sum_{\ell=0}^d q_{i\ell}^m q_{j\ell}^h \quad (0 \leq i, j, m, h \leq d), \quad (2.28)$$

$$\sum_{h=0}^d q_{mh}^i q_{j\ell}^h = \sum_{h=0}^d q_{jh}^i q_{m\ell}^h \quad (0 \leq i, j, m, \ell \leq d). \quad (2.29)$$

PROOF. Pick  $j$  ( $0 \leq j \leq d$ ). We have  $E_0 \circ E_j = \frac{1}{|X|} \sum_{h=0}^d q_{0j}^h E_h$ , and because of (2.6),  $E_0 \circ E_j = \frac{1}{|X|} E_j$ . This yields (2.24). The proof for (2.25) is similar. Note that

$$\sum (E_i) = \delta_{0i} |X|, \quad (2.30)$$

since  $\sum (E_i) J = J E_i J = |X| E_0 E_i J = \delta_{0i} |X| J$  (see (2.20)). Now (2.26) follows from  $q_{ij}^0 = \sum (E_i \circ E_j) = \text{trace}(E_i E_j) = \delta_{ij} m_j$  (see (2.19)). Since

$$E_i \circ E_j \circ E_h = \frac{1}{|X|} \sum_{\ell=0}^d q_{ij}^\ell (E_\ell \circ E_h) = \frac{1}{|X|^2} \sum_{\ell=0}^d \sum_{m=0}^d q_{ij}^\ell q_{\ell h}^m E_m$$

and

$$E_i \circ E_j \circ E_h = \frac{1}{|X|} \sum_{\ell=0}^d q_{jh}^\ell (E_i \circ E_\ell) = \frac{1}{|X|^2} \sum_{\ell=0}^d \sum_{m=0}^d q_{i\ell}^m q_{j\ell}^h E_m,$$

we have (2.28). The proof for (2.29) is similar, however instead of  $E_i \circ E_j \circ E_h$  we consider  $E_m \circ (E_j \circ E_\ell) = E_j \circ (E_m \circ E_\ell)$ . Relation (2.27) follows from (2.28) by taking  $m = 0$ . ■

### 2.5.1 The operator $\rho(x)$

To our knowledge a notion of operator  $\rho(x)$  is due to P. TERWILLIGER [49]. We use this operator to prove that  $\sum_{i=0}^d q_{ij}^h = m_j$  ( $0 \leq j \leq d$ ) holds for walk-regular graphs.

**Definition 2.32** Let  $\Gamma = (X, \mathcal{R})$  denote a simple graph. For any  $x \in X$  and any  $B \in \text{Mat}_X(\mathbb{F})$  let  $B^{\rho(x)}$  denote the diagonal matrix in  $\text{Mat}_X(\mathbb{F})$  with  $(y, y)$ -entry

$$(B^{\rho(x)})_{yy} := B_{xy} \quad \forall y \in X,$$

that is,

$$B = x \begin{pmatrix} \vdots & \vdots & & \vdots \\ a & b & \dots & c \\ \vdots & \vdots & & \vdots \\ \vdots & \vdots & & \vdots \end{pmatrix} \xrightarrow{\rho(x)} \begin{pmatrix} a & 0 & \dots & 0 \\ 0 & b & \dots & 0 \\ \vdots & \vdots & & \vdots \\ 0 & 0 & \dots & c \end{pmatrix} = B^{\rho(x)}.$$

**Lemma 2.33** *With the reference to Definition 2.32, pick  $x \in X$ . Then the following (i)–(iii) hold.*

$$(i) \quad (B \circ C)^{\rho(x)} = B^{\rho(x)} C^{\rho(x)} \quad \forall B, C \in \text{Mat}_X(\mathbb{F}).$$

$$(ii) \quad J^{\rho(x)} = I.$$

(iii) *If  $\Gamma$  is walk-regular then for all  $B, C \in \mathcal{A} = (\langle A \rangle, +, \cdot)$  we have*

$$\langle B^{\rho(x)}, C^{\rho(x)} \rangle = |X|^{-1} \langle B, C \rangle.$$

PROOF. (i), (ii) Routine.

(iii) Pick  $B, C \in \mathcal{A}$ . We have

$$\begin{aligned} \langle B^{\rho(x)}, C^{\rho(x)} \rangle &= |X|^{-1} \text{trace}(B^{\rho(x)} \overline{(C^{\rho(x)})^\top}) = |X|^{-1} \text{trace}(B^{\rho(x)} C^{\rho(x)}) = \\ &= |X|^{-1} \sum_{y \in X} (B^{\rho(x)})_{yy} (C^{\rho(x)})_{yy} = |X|^{-1} \sum_{y \in X} B_{xy} \overline{C_{xy}} = |X|^{-1} (B \overline{C}^\top)_{xx} \end{aligned}$$

and since number of closed walks of length  $\ell \geq 0$  does not depend on choice of vertex the diagonal entries in  $B \overline{C}^\top$  are all equal and thus

$$\langle B, C \rangle = |X|^{-1} \text{trace}(B \overline{C}^\top) = |X|^{-1} \sum_{y \in X} (B \overline{C}^\top)_{yy} = (B \overline{C}^\top)_{xx}.$$

The result follows. ■

**Corollary 2.34** *If  $\Gamma$  is walk-regular then*

$$(E_h)_{xx} = \frac{m_h}{|X|}, \quad \langle I^{\rho(x)}, E_h^{\rho(x)} \rangle = |X|^{-2} m_h \quad (0 \leq h \leq d)$$

and

$$\langle (I \circ E_j)^{\rho(x)}, E_h^{\rho(x)} \rangle = m_j |X|^{-1} \langle I^{\rho(x)}, E_h^{\rho(x)} \rangle \quad (0 \leq j, h \leq d).$$

PROOF. Note that  $(I \circ E_j)^{\rho(x)} = m_j |X|^{-1} I^{\rho(x)}$ . The result follows from Propositions 2.3, 2.4, 2.5, Definition 2.32 and Lemma 2.33. ■

**Theorem 2.35** *With reference to 2.28, if the graph  $\Gamma$  is walk-regular then*

$$\sum_{i=0}^d q_{ij}^h = m_j \quad (0 \leq j \leq d). \quad (2.31)$$

PROOF. By Corollary 2.34, we have

$$\begin{aligned} \sum_{i=0}^d q_{ij}^h &= |X| m_h^{-1} \langle E_h, E_h \rangle \sum_{i=0}^d q_{ij}^h = |X| m_h^{-1} \sum_{i=0}^d \langle q_{ij}^h E_h, E_h \rangle = |X| m_h^{-1} \sum_{i=0}^d \langle \sum_{\ell=0}^d q_{ij}^\ell E_\ell, E_h \rangle \\ &= |X|^2 m_h^{-1} \sum_{i=0}^d \langle E_i \circ E_j, E_h \rangle = |X|^2 m_h^{-1} \langle \sum_{i=0}^d E_i \circ E_j, E_h \rangle = |X|^2 m_h^{-1} \langle I \circ E_j, E_h \rangle \\ &= |X|^3 m_h^{-1} \langle (I \circ E_j)^{\rho(x)}, E_h^{\rho(x)} \rangle = |X|^3 m_h^{-1} m_j |X|^{-1} \langle I^{\rho(x)}, E_h^{\rho(x)} \rangle \\ &= |X|^2 m_h^{-1} m_j |X|^{-2} m_h = m_j. \end{aligned}$$

■

# Distance-regular graphs

In this chapter, we recall some definitions and basic concepts. See the book of Brouwer, Cohen and Neumaier [3] or a recent survey by E.R. Van Dam, J. H. Koolen and H. Tanaka [14] for more background information.

## 3.1 Distance-regular graph

**Definition 3.1** Let  $\Gamma = (X, \mathcal{R})$  be a graph with diameter  $D$ . For a vertex  $x \in X$  and any non-negative integer  $h$  not exceeding  $D$ , let  $\Gamma_h(x)$  denote the subset of vertices in  $X$  that are at distance  $h$  from  $x$ . Put  $\Gamma_{-1}(x) = \Gamma_{D+1}(x) := \emptyset$ . For any two vertices  $x$  and  $y$  in  $X$  at distance  $h$ , let

$$\begin{aligned} C(x, y) &= C_h(x, y) := \Gamma_{h-1}(x) \cap \Gamma_1(y), \\ A(x, y) &= A_h(x, y) := \Gamma_h(x) \cap \Gamma_1(y), \\ B(x, y) &= B_h(x, y) := \Gamma_{h+1}(x) \cap \Gamma_1(y) \end{aligned}$$

and

$$\Gamma_{ij}(x, y) = \Gamma_{ij}^h(x, y) := \Gamma_i(x) \cap \Gamma_j(y).$$

A graph  $\Gamma$  is called *distance-regular* if there are integers  $b_i, c_i$  ( $0 \leq i \leq D$ ) which satisfy  $c_i = |C_i(x, y)|$  and  $b_i = |B_i(x, y)|$  for any two vertices  $x$  and  $y$  in  $X$  at distance  $i$ . For notational convenience, set

$$\begin{aligned} k_i &= k_i(x) := |\Gamma_i(x)|, \\ a_i &= b_0 - c_i - b_i \quad (0 \leq i \leq D), \\ p_{ij}^h &= p_{ij}^h(x, y) := |\Gamma_{ij}^h(x, y)| = |\{z \in X \mid \partial(x, z) = i, \partial(y, z) = j\}| \end{aligned}$$

and define  $c_0 = 0, b_D = 0, k = k_1$ .

**Lemma 3.2** *With reference to Definition 3.1, if  $\Gamma$  is a distance-regular graph then the following (i)–(iv) hold.*

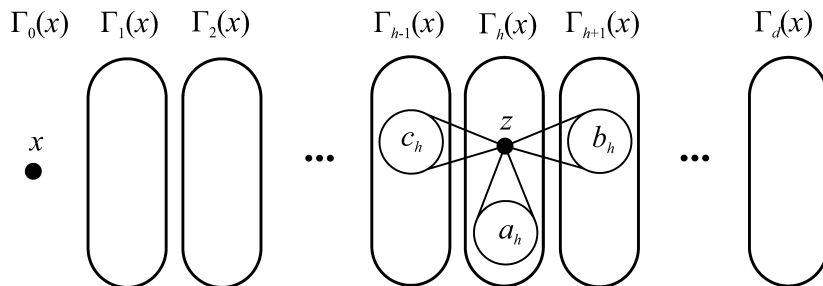

**Figure 3.1.** Intersection diagram (of rank 0) with respect to  $x$  and illustration for coefficients  $c_h, a_h$  and  $b_h$ .



(i)  $c_1 = 1$ ,  $\Gamma$  is regular with valency  $k = k_1 = b_0$  and

$$c_i + a_i + b_i = k \quad (0 \leq i \leq D). \quad (3.1)$$

(ii)  $\forall x \in X$ ,  $k_i = p_{ii}^0 = |\Gamma_{ii}^0(x)| = \frac{b_0 b_1 \dots b_{i-1}}{c_1 c_2 \dots c_i}$  ( $1 \leq i \leq D$ ).

(iii)  $p_{ij}^0 = p_{ij}^0(x, x) = \delta_{ij} k_i \forall x \in X$ .

(iv)  $p_{i-1,i}^1 = \frac{k_i c_{i-1}}{k} = \frac{k_{i-1} b_{i-1}}{k}$ ,  $p_{ii}^1 = \frac{k_i a_i}{k}$  and  $p_{i,i+1}^1 = \frac{b_i k_i}{k}$  ( $1 \leq i \leq D-1$ ).

PROOF. (i) Immediate from Definition 3.1 ( $b_0 = |B_0(x, x)|$  and for  $x \in X$ ,  $y \in \Gamma_1(x)$  we have  $c_1 = |\Gamma_0(x) \cap \Gamma_1(y)| = 1$ ).

(ii) For every  $x \in X$  and every  $i$  ( $1 \leq i \leq D$ ) note that  $|\Gamma_i(x)| b_i = |\Gamma_{i+1}(x)| c_{i+1}$ . The result follows.

(iii)  $p_{ij}^0 = |\Gamma_i(x) \cap \Gamma_j(x)| = \delta_{ij} |\Gamma_i(x)|$ . The result follows.

(iv) Pick  $x \in X$  and count the number of pairs  $(y, z)$  in two different ways, where  $y \in \Gamma_i(x)$ ,  $z \in \Gamma_1(x)$  and  $\partial(y, z) = i-1$ .

There are  $|\Gamma_i(x)|$  choices for  $y$ , and so the total number of ordered pairs  $(y, z)$  is  $|\Gamma_i(x)| c_{i-1}$ . On the other hand there are  $|\Gamma_1(x)|$  choices for  $z$ , and so the total number of ordered pairs is  $|\Gamma_1(x)| p_{i-1,i}^1(z, x)$ . The first part of the first equation follows. The proofs of the second part of the first equation, and for the second and the third equation are similar. ■

**Lemma 3.3** *With reference to Definition 3.1, let  $\Gamma$  denote a distance-regular graph and pick  $i, j$  ( $0 \leq i, j \leq D$ ). If  $i+1 < j$  or  $j+1 < i$  then*

$$p_{1j}^i(x, y) = 0 \quad \forall x \in X, y \in \Gamma_i(x).$$

Moreover, for all  $h, i, j$  ( $0 \leq i, j, h \leq D$ ), the following (i), (ii) hold.

(i) If one of  $h, i, j$  is larger than the sum of the other two then  $p_{ij}^h = 0$ .

(ii) If one of  $h, i, j$  equals the sum of the other two then  $p_{ij}^h \neq 0$ .

PROOF. Routine. ■

**Theorem 3.4** *With reference to Definition 3.1, a connected graph  $\Gamma = (X, \mathcal{R})$  of diameter  $D$  is a distance-regular if and only if for all integers  $h, i, j$  ( $0 \leq h, i, j \leq D$ ) and for all  $x \in X$ ,  $y \in \Gamma_h(x)$ , the number*

$$p_{ij}^h = |\Gamma_{ij}^h(x, y)| = |\{z \in X \mid \partial(x, z) = i, \partial(y, z) = j\}|$$

is independent of  $x$  and  $y$ . The constants  $p_{ij}^h$  are known as the intersection numbers of  $\Gamma$ . Moreover

$$p_{ij}^{h+1} = \frac{1}{b_h} \left( b_{j-1} p_{i,j-1}^h + (a_j - a_h) p_{ij}^h + c_{j+1} p_{i,j+1}^h - c_h p_{ij}^{h-1} \right). \quad (3.2)$$

PROOF. If the numbers  $p_{ij}^h = |\Gamma_{ij}^h(x, y)|$  ( $0 \leq i, j, h \leq D$ ) are independent of  $x \in X$  and  $y \in \Gamma_h(x)$  then it is not hard to see that  $\Gamma$  is a distance-regular graph with  $c_i = p_{1,i-1}^i$  ( $1 \leq i \leq D$ ),  $a_i = p_{1i}^i$  ( $0 \leq i \leq D$ ) and  $b_i = p_{1,i+1}^i$  ( $0 \leq i \leq D-1$ ).

Now, assume that  $\Gamma$  is distance-regular graph. We will prove that the number  $p_{ij}^m = |\Gamma_{ij}^m(x, y)|$  is independent of  $x \in X$  and  $y \in \Gamma_m(x)$ . We use mathematical induction on  $m$ . The basis of induction holds by Lemma 3.2, since the numbers  $p_{ij}^0$  and  $p_{ij}^1$  ( $0 \leq i, j \leq D$ ) are independent of  $x$  and  $y$ . For induction step, assume that the numbers  $p_{ij}^{\ell}$  ( $0 \leq i, j \leq D$ ) are

independent of  $x \in X$  and  $y \in \Gamma_\ell$  for every  $1 \leq \ell \leq h$ , and let us prove that the numbers  $p_{ij}^{h+1}$  ( $0 \leq i, j \leq D$ ) are independent of  $x \in X$  and  $y \in \Gamma_{h+1}(x)$ . For that purpose pick  $x \in X$ ,  $y \in \Gamma_h(x)$  and let's count the number of pairs  $(w, z)$  in two different ways, where  $w \in \Gamma_i(x)$ ,  $z \in \Gamma_1(y)$  and  $\partial(w, z) = j$ . If we first pick  $w$  then the number of ordered pairs  $(w, z)$  is

$$\sum_{r=0}^D p_{ir}^h p_{j1}^r = \sum_{r=j-1}^{j+1} p_{ir}^h p_{j1}^r = p_{i,j-1}^h b_{j-1} + p_{ij}^h a_j + p_{i,j+1}^h c_{j+1}$$

(because of Lemma 3.3). On the other hand if we first pick  $z$  then the number of ordered pairs  $(w, z)$  is

$$\sum_{\ell=0}^D p_{\ell 1}^h p_{ij}^\ell = \sum_{\ell=h-1}^{h+1} p_{\ell 1}^h p_{ij}^\ell = c_h p_{ij}^{h-1} + a_h p_{ij}^h + b_h p_{ij}^{h+1}$$

(because of Lemma 3.3). With that we have (3.2). The result follows.  $\blacksquare$

**Lemma 3.5** *With reference to Theorem 3.4, for every  $i, j, h$  ( $0 \leq i, j, h \leq D$ ) we have*

$$k_h p_{ij}^h = k_i p_{jh}^i = k_j p_{ih}^j.$$

**PROOF.** Pick  $x \in X$  and count the numbers of ordered pairs  $(y, z)$  in two different ways, where  $y \in \Gamma_i(x)$ ,  $z \in \Gamma_j(x)$  and  $\partial(y, z) = h$ .  $\blacksquare$

**Corollary 3.6** *With reference to Theorem 3.4, let  $\lambda = a_1$ . For every  $i$  ( $1 \leq i \leq D-1$ ) we have*

$$\begin{aligned} p_{i+1,i-1}^2 &= p_{i-1,i+1}^2 = \frac{b_2 b_3 \dots b_i}{c_1 c_2 \dots c_{i-1}} = \frac{k_i c_i b_i}{k b_1}, \\ p_{i,i+1}^2 &= p_{i+1,i}^2 = \frac{b_2 b_3 \dots b_i}{c_1 c_2 \dots c_i} (a_i + a_{i+1} - \lambda) = \frac{k_i c_i}{k b_1} (a_i + a_{i+1} - \lambda), \\ p_{22}^2 &= \frac{1}{c_2} (c_2 b_1 + a_2^2 + c_3 b_2 - k - \lambda a_2) = \frac{1}{c_2} (c_2 (b_1 - 1) + b_2 (c_3 - 1) + a_2 (a_2 - \lambda - 1)), \\ p_{ii}^2 &= \frac{b_2 b_3 \dots b_{i-1}}{c_1 c_2 \dots c_i} (c_i b_{i-1} + a_i^2 + c_{i+1} b_i - k - \lambda a_i), \\ p_{2i}^i &= \frac{1}{c_2} (c_i b_{i-1} + a_i (a_i - \lambda) + b_i c_{i+1} - k). \end{aligned}$$

In addition, for every  $j$  ( $0 \leq j \leq D$ ,  $i+j \leq D$ ,  $i-j \geq 0$ ) we have

$$\begin{aligned} p_{ij}^{i+j} &= \frac{c_{i+1} \dots c_{i+j}}{c_1 \dots c_j}, & p_{ij}^{i-j} &= \frac{b_{i-1} \dots b_{i-j}}{c_1 \dots c_j}, \\ p_{i,j+1}^{i+j} &= p_{ij}^{i+j} \frac{a_i + \dots + a_{i+j} - a_1 - \dots - a_j}{c_{j+1}}, & p_{i,j+1}^{i-j} &= p_{ij}^{i-j} \frac{a_i + \dots + a_{i-j} - a_1 - \dots - a_j}{c_{j+1}}. \end{aligned}$$

**PROOF.** Use (3.2) and induction on  $h$  (and if necessary Lemmas 3.2 and 3.5).  $\blacksquare$

Note that by Definition 3.1,  $k_i = |\Gamma_i(x)|$  for  $x \in X$  and  $0 \leq i \leq D$ . By Lemma 3.2(ii),

$$k_i = \frac{b_0 b_1 \dots b_{i-1}}{c_1 c_2 \dots c_i} \quad (0 \leq i \leq D). \quad (3.3)$$

By Lemma 3.5, we have  $k_2 p_{ii}^2 = k_i p_{2i}^i$  ( $1 \leq i \leq D-1$ ). Recall  $\Gamma$  is *bipartite* whenever  $a_i = 0$  for  $0 \leq i \leq D$ . Setting  $a_i = 0$  in  $c_i + a_i + b_i = k$  ( $0 \leq i \leq D$ ) we find

$$b_i + c_i = k \quad (0 \leq i \leq D). \quad (3.4)$$

**Corollary 3.7** *Let  $\Gamma$  denote a bipartite distance-regular graph with diameter  $D \geq 2$  and valency  $k \geq 3$ . Then the following (i)–(v) hold.*

- (i)  $k_i b_i = k_{i+1} c_{i+1} \quad (0 \leq i \leq D-1).$
- (ii)  $p_{i-2,i}^2 = p_{i,i-2}^2 = \frac{k_i c_{i-1} c_i}{k(k-1)} \quad (2 \leq i \leq D).$
- (iii)  $p_{2,i-2}^i = \frac{c_{i-1} c_i}{c_2} \quad (2 \leq i \leq D).$
- (iv)  $p_{2,i+2}^i = \frac{b_i b_{i+1}}{c_2} \quad (0 \leq i \leq D-2).$
- (v)  $p_{2i}^i = \frac{c_i(b_{i-1} - 1) + b_i(c_{i+1} - 1)}{c_2} \quad (1 \leq i \leq D-1) \quad \text{and}$   

$$p_{2D}^D = \frac{k(b_{D-1} - 1)}{c_2}.$$

PROOF. Immediate from Corollary 3.6. ■

## 3.2 Standard module

**Definition 3.8** Let  $\Gamma = (X, \mathcal{R})$  denote a distance-regular graph with intersection numbers  $p_{ij}^h$  ( $0 \leq i, j, h \leq D$ ). Let  $\text{Mat}_X(\mathbb{C})$  denote the  $\mathbb{C}$  algebra of matrices with complex entries whose rows and columns are indexed by  $X$ . By the *standard module* for  $X$ , we mean the vector space  $V = \mathbb{C}^{|X|}$  of column vectors whose coordinates are indexed by  $X$ . Observe that  $\text{Mat}_X(\mathbb{C})$  acts on  $V$  by left multiplication. We endow  $V$  with the Hermitian inner product defined by

$$\langle u, v \rangle = u^\top \bar{v} \quad (u, v \in V). \quad (3.5)$$

Recall that

$$\langle u, Bv \rangle = \langle \bar{B}^\dagger u, v \rangle \quad (3.6)$$

for  $u, v \in V$  and  $B \in \text{Mat}_X(\mathbb{C})$ . For each  $y \in X$ , let  $\hat{y}$  denote the element of  $V$  with a 1 in the  $y$  coordinate and zeros everywhere else.

**Lemma 3.9** *With reference to Definition 3.8, we have*

$$\{\hat{y} \mid y \in X\} \text{ is an orthonormal basis for } V. \quad (3.7)$$

PROOF. Routine. ■

**Lemma 3.10** *With reference to Definition 3.8, let  $\mathcal{A}$  denote the adjacency algebra of  $\Gamma$  (the subalgebra of  $\text{Mat}_X(\mathbb{C})$  generated by  $A$ ) and let  $A_i$  ( $0 \leq i \leq D$ ) be the distance- $i$  matrix for  $\Gamma$ . We have*

$$A_i \hat{y} = \sum_{w \in \Gamma_i(y)} \hat{w} \quad (y \in X, 0 \leq i \leq D), \quad (3.8)$$

$$\sum_{h=0}^D A_h = J, \quad (3.9)$$

$$A_i A_j = \sum_{h=0}^D p_{ij}^h A_h \quad (0 \leq i, j \leq D), \quad (3.10)$$

$$AA_j (= A_j A) = b_{j-1} A_{j-1} + a_j A_j + c_{j+1} A_{j+1} \quad (0 \leq j \leq D), \quad (3.11)$$

$$\{A_0, A_1, \dots, A_D\} \text{ is a basis for } \mathcal{A}. \quad (3.12)$$

PROOF. (3.8) and (3.9) are trivial. For (3.10) note that  $(A_i A_j)_{xy} = |\Gamma_i(x) \cap \Gamma_j(y)|$ , and the result follows. (3.11) follows from (3.10) by setting  $i = 1$ .

It is only left to show that (3.12) holds. For that purpose consider the vector space  $\mathcal{D} = \text{span}\{A_0, A_1, \dots, A_D\}$ , and note that  $\mathcal{D}$  forms an algebra with respect to the elementwise Hadamard product of matrices. By (3.10),  $\mathcal{D}$  also forms an algebra with respect to the ordinary product of matrices. Next, we will show that  $A^i \in \mathcal{D}$  ( $i = 1, 2, \dots$ ) using mathematical induction on  $i$ . The basis of induction holds, since  $A^0 = A_0$  and  $A^1 = A_1$ . Now assume that  $A^h \in \mathcal{D}$  for  $1 \leq h \leq m$  and let's prove that  $A^{m+1} \in \mathcal{D}$ . This follows immediate from (3.11), since

$$A^{m+1} = AA^m = A(\alpha_0 A_0 + \alpha_1 A_1 + \dots + \alpha_D A_D) \text{ (for some } \alpha_i \text{'s)}.$$

With that we have proved that  $\mathcal{A} \subseteq \mathcal{D}$ . Since  $\dim(\mathcal{A}) \geq D + 1$  the result follows.  $\blacksquare$

**Corollary 3.11** *If  $\Gamma$  is a distance regular-graph with  $d + 1$  distinct eigenvalues and diameter  $D$ , then*

$$d = D.$$

PROOF. Immediate from (3.12) and Corollary 2.11.  $\blacksquare$

### 3.3 Dual eigenvalue sequence

Let  $\Gamma$  denote a distance-regular graph. Since  $\{E_i\}_{i=0}^D$  form a basis for Bose-Mesner algebra  $\mathcal{M}$  (see Corollary 2.11 and (3.12)), there exist real scalars  $\{\theta_i\}_{i=0}^D$  such that  $A = \sum_{i=0}^D \theta_i E_i$ . By Proposition 2.10,  $\theta_i$  is the *eigenvalue* of  $\Gamma$  associated with  $E_i$ . By Corollary 2.8, for  $0 \leq i \leq D$  the space  $E_i V$  is the eigenspace of  $A$  associated with  $\theta_i$ . Let  $m_i$  denote the rank of  $E_i$  ( $0 \leq i \leq D$ ). Observe that  $m_i$  is the dimension of the eigenspace  $E_i V$  ( $0 \leq i \leq D$ ). We call  $m_i$  the *multiplicity* of  $\theta_i$ . Observe that  $\{\theta_i\}_{i=0}^D$  are mutually distinct since  $A$  generates  $\mathcal{M}$ . By (2.6) we have  $\theta_0 = k$ .

**Definition 3.12** Let  $\theta$  denote an eigenvalue of distance-regular graph  $\Gamma$ , and let  $E$  denote the associated primitive idempotent. For  $0 \leq i \leq D$  define a real number  $\theta_i^*$  by

$$E = |X|^{-1} \sum_{i=0}^D \theta_i^* A_i.$$

We call the sequence  $\theta_0^*, \theta_1^*, \dots, \theta_D^*$  the *dual eigenvalue sequence* associated with  $\theta, E$ . We say the sequence is *trivial* whenever  $E = E_0$  (in which case  $\theta_0^* = \theta_1^* = \dots = \theta_D^* = 1$ ).

In the following lemma, we cite a well known result about primitive idempotents.

**Lemma 3.13** ([48, Lemma 1.1]) *Let  $\Gamma$  denote a distance-regular graph with diameter  $D \geq 3$ , let  $E$  denote a primitive idempotent of  $\Gamma$ , and let  $\theta_0^*, \theta_1^*, \dots, \theta_D^*$  denote the corresponding dual eigenvalue sequence. Then for  $0 \leq i \leq D$  and for all  $x, y \in X$  with  $\partial(x, y) = i$  we have  $\langle E\hat{x}, E\hat{y} \rangle = |X|^{-1} \theta_i^*$ .*

### 3.4 The $Q$ -polynomial property

We continue to discuss the distance-regular graph  $\Gamma = (X, \mathcal{R})$ . In this section we define the  $Q$ -polynomial property of  $\Gamma$ . We first recall the Krein parameters of  $\Gamma$  (from Section 2.5). Let

$\circ$  denote the entrywise product in  $\text{Mat}_X(\mathbb{C})$ . Observe  $A_i \circ A_j = \delta_{ij} A_i$  for  $0 \leq i, j \leq D$ , so  $\mathcal{M}$  is closed under  $\circ$ . Thus there exist  $q_{ij}^h \in \mathbb{R}$  ( $0 \leq h, i, j \leq D$ ) such that

$$E_i \circ E_j = |X|^{-1} \sum_{h=0}^D q_{ij}^h E_h \quad (0 \leq i, j \leq D).$$

The parameters  $q_{ij}^h$  are called the *Krein parameters* of  $\Gamma$ . By (2.22) the Krein parameters of  $\Gamma$  are nonnegative.

**Lemma 3.14** ([16, Lemma 1.4.1]) *Let  $\{E_i\}_{i=0}^D$  denote an ordering of the primitive idempotents of a distance-regular graph  $\Gamma$  and let  $q_{ij}^h$  denote the Krein parameters. Then the following (i), (ii) are equivalent.*

(i) For  $0 \leq i, j \leq D$

$$\begin{aligned} q_{1j}^i &= 0, & j &> i + 1; \\ q_{1j}^i &\neq 0, & j &= i + 1. \end{aligned}$$

(ii) For  $0 \leq i, j, h \leq D$

$$\begin{aligned} q_{ij}^h &= 0 & \text{if one of } h, i, j & \text{ is greater than the sum of the other two} \\ q_{ij}^h &\neq 0 & \text{if one of } h, i, j & \text{ is equal to the sum of the other two.} \end{aligned}$$

**Definition 3.15** With the notation of Lemma 3.14, if (i), (ii) hold then  $\{E_i\}_{i=0}^D$  is said to be a  $Q$ -polynomial ordering for  $\Gamma$ . Let  $E$  denote a nontrivial primitive idempotent of  $\Gamma$  and let  $\theta$  denote the corresponding eigenvalue. We say  $\Gamma$  is  $Q$ -polynomial with respect to  $E$  (or  $Q$ -polynomial with respect to  $\theta$ ) whenever there exists a  $Q$ -polynomial ordering  $\{E_i\}_{i=0}^D$  of the primitive idempotents such that  $E_1 = E$ . In this case, we abbreviate  $a_i^* = q_{1i}^i$ ,  $b_i^* = q_{1,i+1}^i$ ,  $c_i^* = q_{1,i-1}^i$ ,  $k_i^* = q_{ii}^0$  and  $k^* = k_1^* = b_0^*$ .

We have the following useful lemmas about the  $Q$ -polynomial property.

**Lemma 3.16** ([3, Thm. 8.1.1]) *Let  $\Gamma$  denote a distance-regular graph with diameter  $D \geq 3$ . Let  $E$  denote a nontrivial primitive idempotent of  $\Gamma$  and let  $\{\theta_i^*\}_{i=0}^D$  denote the corresponding dual eigenvalue sequence. Suppose  $\Gamma$  is  $Q$ -polynomial with respect to  $E$ . Then  $\theta_0^*, \theta_1^*, \dots, \theta_D^*$  are mutually distinct.*

**Theorem 3.17** ([48, Thm. 3.3]) *Let  $\Gamma$  denote a distance-regular graph with diameter  $D \geq 3$ . Let  $E$  denote a nontrivial primitive idempotent of  $\Gamma$  and let  $\{\theta_i^*\}_{i=0}^D$  denote the corresponding dual eigenvalue sequence. Then the following (i), (ii) are equivalent.*

(i)  $\Gamma$  is  $Q$ -polynomial with respect to  $E$ .

(ii)  $\theta_0^* \neq \theta_i^*$  for  $1 \leq i \leq D$ ; for all integers  $h, i, j$  ( $1 \leq h \leq D$ ), ( $0 \leq i, j \leq D$ ) and for all vertices  $x, y \in X$  with  $\partial(x, y) = h$  the following hold:

$$\sum_{\substack{z \in X \\ \partial(x,z)=i \\ \partial(y,z)=j}} E\hat{z} - \sum_{\substack{z \in X \\ \partial(x,z)=j \\ \partial(y,z)=i}} E\hat{z} \in \text{span}\{E\hat{x} - E\hat{y}\}.$$

Suppose (i), (ii) hold. Then for all integers  $h, i, j$  ( $1 \leq h \leq D$ ), ( $0 \leq i, j \leq D$ ) and for all  $x, y \in X$  such that  $\partial(x, y) = h$ ,

$$\sum_{\substack{z \in X \\ \partial(x,z)=i \\ \partial(y,z)=j}} E\hat{z} - \sum_{\substack{z \in X \\ \partial(x,z)=j \\ \partial(y,z)=i}} E\hat{z} = p_{ij}^h \frac{\theta_i^* - \theta_j^*}{\theta_0^* - \theta_h^*} (E\hat{x} - E\hat{y}). \quad (3.13)$$

We have the following two important results about bipartite  $Q$ -polynomial distance-regular graphs.

**Lemma 3.18** ([6, Lemmas 3.2, 3.3]) *Let  $\Gamma$  denote a bipartite distance-regular graph with diameter  $D \geq 4$ , valency  $k \geq 3$ , and intersection numbers  $b_i, c_i$ . Let  $\{E_i\}_{i=0}^D$  be a  $Q$ -polynomial ordering of primitive idempotents of  $\Gamma$ , and let  $\{\theta_i^*\}_{i=0}^D$  denote the dual eigenvalue sequence associated with  $E_1$ . For  $0 \leq i \leq D$  let  $\theta_i$  denote the eigenvalue associated with  $E_i$ . Assume  $\Gamma$  is not the  $D$ -cube or the antipodal quotient of the  $2D$ -cube. Then there exist scalars  $q, s^* \in \mathbb{R}$  such that (i)–(iii) hold below.*

$$(i) \quad |q| > 1, \quad s^* q^i \neq 1 \quad (2 \leq i \leq 2D + 1);$$

$$(ii) \quad \theta_i = h(q^{D-i} - q^i), \quad \theta_i^* = \theta_0^* + h^*(1 - q^i)(1 - s^* q^{i+1})q^{-i} \quad \text{for } 0 \leq i \leq D, \text{ where}$$

$$h = \frac{1 - s^* q^3}{(q - 1)(1 - s^* q^{D+2})}, \quad h^* = \frac{(q^D + q^2)(q^D + q)}{q(q^2 - 1)(1 - s^* q^{2D})},$$

$$\theta_0^* = \frac{h^*(q^D - 1)(1 - s^* q^2)}{q(q^{D-1} + 1)};$$

$$(iii) \quad k = c_D = h(q^D - 1), \text{ and for } 1 \leq i \leq D - 1$$

$$c_i = \frac{h(q^i - 1)(1 - s^* q^{D+i+1})}{1 - s^* q^{2i+1}}, \quad b_i = \frac{h(q^D - q^i)(1 - s^* q^{i+1})}{1 - s^* q^{2i+1}}.$$

**Theorem 3.19** ([34, Theorem 9.1]) *Assume that  $\Gamma$  is  $Q$ -polynomial with respect to a primitive idempotent  $E$  and fix vertices  $x, y \in X$  such that  $\partial(x, y) = 2$ . Let  $\theta_0^*, \theta_1^*, \dots, \theta_D^*$ , denote the corresponding dual eigenvalue sequence. Then for  $2 \leq i \leq D - 1$  the following holds*

$$|\Gamma_{i-1}(x) \cap \Gamma_{i-1}(y) \Gamma_1(z)| = \alpha_i + \beta_i |\Gamma_1(x) \cap \Gamma_1(y) \cap \Gamma_{i-1}(z)|$$

where

$$\alpha_i = c_i \frac{(\theta_0^* - \theta_i^*)(\theta_3^* - \theta_{i+1}^*) - (\theta_1^* - \theta_{i-1}^*)(\theta_2^* - \theta_i^*)}{(\theta_0^* - \theta_i^*)(\theta_{i-1}^* - \theta_{i+1}^*)}$$

and

$$\beta_i = \frac{\theta_1^* - \theta_3^*}{\theta_{i-1}^* - \theta_{i+1}^*}.$$

## 3.5 Examples

In this section we give some examples of  $Q$ -polynomial distance-regular graphs that we will need later. For each graph we give the intersection array  $\{b_0, \dots, b_{D-1}; c_1, \dots, c_D\}$ , the eigenvalues  $\theta_0, \dots, \theta_D$  and the  $Q$ -polynomial structures. Our examples are from [2, 3, 16, 47].

In each case the graph is known to be  $Q$ -polynomial distance-regular with diameter  $d$ . We denote the natural ordering of the primitive idempotents by  $E_0, E_1, \dots, E_D$ . First we recall the notion of a *dual bipartite*  $Q$ -polynomial structure for a distance-regular graph.

**Lemma 3.20** ([16, Lemma 2.1.1]) *Let  $\Gamma$  denote a distance-regular graph with diameter  $D \geq 3$ . Suppose  $E_0, \dots, E_D$  is a  $Q$ -polynomial structure for  $\Gamma$ , with Krein parameters  $q_{ij}^h$ . Then the following (i), (ii) are equivalent.*

$$(i) \quad q_{1i}^i = 0 \quad (1 \leq i \leq D).$$

$$(ii) \quad \text{For } 0 \leq i, j, h \leq D$$

$$q_{ij}^h = 0, \quad \text{if } h + i + j \text{ is odd.}$$

If (i), (ii) hold, the  $Q$ -polynomial structure is said to be *dual bipartite*; if  $\Gamma$  admits at least one dual bipartite  $Q$ -polynomial structure, then  $\Gamma$  is said to be *dual bipartite*.

### 3.5.1 Johnson graphs

The *Johnson graph*  $J(d, n) = (X, \mathcal{R})$ , is the graph whose vertices are the  $n$ -element subsets of a  $d$ -element set  $S$ . Two vertices are adjacent if the size of their intersection is exactly  $d - 1$ . To put it on another way, vertices are adjacent if they differ in only one element. With that we have

$$\begin{aligned} X &= \text{all subsets of } \{1, 2, \dots, n\} \text{ of order } d, \\ \mathcal{R} &= \{xy \in X \times X : |x \cap y| = d - 1\}. \end{aligned}$$

We observe that

$$\begin{aligned} |X| &= \binom{n}{d}, \\ b_i &= (d - i)(n - d - i), \quad 0 \leq i \leq d, \\ a_i &= (d - i)i + i(n - d - i), \quad 0 \leq i \leq d, \\ c_i &= i^2, \quad 0 \leq i \leq d, \\ \theta_i &= (d - i)(n - d - i) - i, \quad 0 \leq i \leq d, \\ m_i &= \binom{d}{i} - \binom{d}{i-1}, \quad 0 \leq i \leq d. \end{aligned}$$

The natural ordering  $E_0, E_1, \dots, E_d$  of the primitive idempotents is the unique  $Q$ -polynomial structure on  $J(d, n)$ . This structure is dual bipartite if  $n = 2$ .

### 3.5.2 Hamming Graphs and Cubes

The *Hamming graph*  $H(d, n) = (X, \mathcal{R})$  is the graph whose vertices are words (sequences or  $d$ -tuples) of length  $d$  ( $d \geq 0$ ) from an alphabet of size  $n \geq 2$ . Two vertices are considered adjacent if the words (or  $d$ -tuples) differ in exactly one coordinate. In another words

$$\begin{aligned} X &= \text{all } d\text{-tuples from the set } \{1, 2, \dots, n\}, \\ \mathcal{R} &= \{xy \in X \times X \mid x, y \text{ differ in exactly 1 coordinate}\}, \end{aligned}$$

We observe that

$$\begin{aligned} |X| &= n^d, \\ b_i &= (d - i)(n - 1), \quad 0 \leq i \leq d - 1, \\ a_i &= i(n - 2), \quad 0 \leq i \leq d, \\ c_i &= i, \quad 1 \leq i \leq d, \\ \theta_i &= n(d - i) - d, \quad 0 \leq i \leq d, \\ m_i &= \binom{n}{i}(d - 1)^i, \quad 0 \leq i \leq d. \end{aligned}$$

The natural ordering  $E_0, E_1, \dots, E_d$  of the primitive idempotents is a  $Q$ -polynomial structure on  $H(d, n)$ . This structure is dual bipartite if  $n = 2$ .

The  $d$ -dimensional hypercube (or shortly  $d$ -cube) is the Hamming graph  $H(d, 2)$ . The cube  $H(d, 2)$  has a second  $Q$ -polynomial structure if  $d$  is even:

$$E_0, E_{d-1}, E_2, \dots, E_{d-2}, E_1, E_d \quad \text{which is dual bipartite.}$$

### 3.5.3 Halved Cubes

As a graph, the  $n$ -dimensional hypercube is bipartite and connected. This induces a partition of its vertex set  $X = \{0, 1\}^n$  into two parts,  $X = X_e \cup X_o$ , where  $X_e$  (respectively,  $X_o$ ) consists of those vertices whose coordinates contain an even (respectively, odd) number of occurrences of 1. The *half cube*  $\frac{1}{2}H(n, 2) = (X, \mathcal{R})$  is defined on the following way:

$$X = X_e = \text{all } n\text{-tuples from the set } \{0, 1\} \text{ of even weight,}$$

$$\mathcal{R} = \{xy \in X \times X \mid x, y \text{ differ in exactly 2 coordinate}\}.$$

Lets mention that, for a bipartite graph  $\tilde{\Gamma} = (Z \cup Y, \tilde{\mathcal{R}})$  with the bipartition  $Z \cup Y$ , the *bipartite half of  $\tilde{\Gamma}$  on  $Z$*  is a graph with vertex set  $Z$  such that two vertices are adjacent whenever they are at distance 2 in  $\tilde{\Gamma}$ . For  $\frac{1}{2}H(2d, 2) = (X, \mathcal{R})$  we observe that

$$\begin{aligned} |X| &= 2^{2d-1}, \\ b_i &= (d-i)(2d-2i-1), \quad 0 \leq i \leq d-1, \\ c_i &= i(2i-1), \quad 1 \leq i \leq d, \\ \theta_i &= 2(d-i)^2 - d, \quad 0 \leq i \leq d, \\ m_i &= \binom{2d}{i}, \quad 0 \leq i \leq d. \end{aligned}$$

The natural ordering of the primitive idempotents is the unique  $Q$ -polynomial structure on  $\frac{1}{2}H(2d, 2)$ :

$$E_0, \dots, E_d \quad \text{which is dual bipartite.}$$

The half-cube  $\frac{1}{2}H(2d+1, 2)$  has

$$\begin{aligned} b_i &= (d-i)(2d-2i+1), \quad 0 \leq i \leq d-1, \\ c_i &= i(2i-1), \quad 1 \leq i \leq d, \\ \theta_i &= 2(d-i)^2 + d - 2i, \quad 0 \leq i \leq d. \end{aligned}$$

There are two  $Q$ -polynomial structures on  $\frac{1}{2}H(2d+1, 2)$ :

$$E_0, \dots, E_d \quad \text{and} \quad E_0, E_2, E_4, \dots, E_5, E_3, E_1.$$

### 3.5.4 Antipodal quotients of cubes

Let  $\Gamma = (X, \mathcal{R})$  denote a finite, connected, undirected graph, without loops or multiple edges and with vertex set  $X$ . We say  $\Gamma$  is *antipodal* if the relation  $R_{0,D} := \{xy \mid \partial(x, y) = 0 \text{ or } D\}$  is an equivalence relation on  $X$ . When  $\Gamma$  is antipodal we define the *antipodal quotient* of  $\Gamma$  to be the graph whose vertices are the equivalence classes of  $R_{0,D}$ , and where two classes are adjacent whenever they contain adjacent vertices of  $\Gamma$ .

The cube  $H(n, 2)$  is antipodal. For  $n = 2d$  and  $n = 2d + 1$ , the antipodal quotient of the cube  $\tilde{H}(n, 2)$  has diameter  $d$  and

$$\begin{aligned} b_i &= n - i, \quad 0 \leq i \leq d-1, \\ c_i &= i, \quad 1 \leq i \leq d, \\ \theta_i &= n - 4i, \quad 0 \leq i \leq d. \end{aligned}$$

The natural ordering of the primitive idempotents is the unique  $Q$ -polynomial structure on  $\tilde{H}(2d, 2)$ :

$$E_0, \dots, E_d.$$

There are two  $Q$ -polynomial structures on  $\tilde{H}(2d+1, 2)$ :

$$E_0, \dots, E_d \quad \text{and} \quad E_0, E_d, E_1, E_{d-1}, E_2, E_{d-2}, \dots .$$



## On bipartite QDRG with $c_2 \leq 2$

---

Let  $\Gamma$  denote a bipartite  $Q$ -polynomial distance-regular graph with diameter  $D \geq 4$ , valency  $k \geq 3$  and intersection number  $c_2 \leq 2$ . The main result of this Chapter is the following theorem.

**Theorem 4.1** *Let  $\Gamma$  denote a bipartite  $Q$ -polynomial distance-regular graph with diameter  $D \geq 4$ , valency  $k \geq 3$ , and intersection number  $c_2 \leq 2$ . Then one of the following holds:*

- (i)  $\Gamma$  is the  $D$ -dimensional hypercube;
- (ii)  $\Gamma$  is the antipodal quotient of the  $2D$ -dimensional hypercube;
- (iii)  $\Gamma$  is a graph with  $D = 5$  not listed above.

To prove the above theorem we use the results of Caughman [6] and, in case when  $c_2 = 2$ , a certain equitable partition of the vertex set of  $\Gamma$  which involves  $4(D - 1) + 2\ell$  cells for some integer  $\ell$  with  $0 \leq \ell \leq D - 2$ . This chapter presents joint work with Š. Miklavič, and the results are published in the “Electronic Journal of Combinatorics **21**” (see [38]).

An *equitable partition* of a graph is a partition  $\pi = \{C_1, C_2, \dots, C_s\}$  of its vertex set into nonempty cells such that for all integers  $i, j$  ( $1 \leq i, j \leq s$ ) the number  $c_{ij}$  of neighbours, which a vertex in the cell  $C_i$  has in the cell  $C_j$ , is independent of the choice of the vertex in  $C_i$ . We call the  $c_{ij}$  the *corresponding parameters*.

### 4.1 The case $D \geq 6$

Let  $\Gamma$  denote a  $Q$ -polynomial bipartite distance-regular graph with diameter  $D \geq 6$ , valency  $k \geq 3$ , and intersection numbers  $b_i, c_i$ . In this section we show that if  $c_2 \leq 2$ , then  $\Gamma$  is either the  $D$ -dimensional hypercube, or the antipodal quotient of the  $2D$ -dimensional hypercube.

**Theorem 4.2** *Let  $\Gamma$  denote a  $Q$ -polynomial bipartite distance-regular graph with diameter  $D \geq 6$  and valency  $k \geq 3$ . If  $c_2 \leq 2$ , then  $\Gamma$  is either the  $D$ -dimensional hypercube, or the antipodal quotient of the  $2D$ -dimensional hypercube.*

**PROOF.** Assume that  $\Gamma$  is not the  $D$ -dimensional hypercube or the antipodal quotient of the  $2D$ -dimensional hypercube. Let scalars  $s^*, q$  be as in Lemma 3.18.

By [6, Lemma 4.1 and Lemma 5.1], scalars  $s^*$  and  $q$  satisfy

$$q > 1, \quad \text{and} \quad -q^{-D-1} \leq s^* < q^{-2D-1}. \quad (4.1)$$

Assume first  $c_2 = 1$ . Abbreviate  $\alpha = 1 + q - q^2 - q^{D-1} + q^D + q^{D+1}$  and observe  $\alpha > 2$ . By Lemma 3.18(iii) we find

$$s^* = \frac{\alpha \pm \sqrt{\alpha^2 - 4q^{D+1}}}{2q^{D+3}}.$$

Note that  $\alpha^2 - 4q^{D+1} \geq 0$ , and so we have

$$s^* \geq \frac{\alpha - \sqrt{\alpha^2 - 4q^{D+1}}}{2q^{D+3}}.$$

We claim

$$\frac{\alpha - \sqrt{\alpha^2 - 4q^{D+1}}}{2q^{D+3}} > q^{-2D-1}.$$

First observe that  $(\alpha q^{D-2} - 2)^2 - q^{2D-4}(\alpha^2 - 4q^{D+1}) = 4(q^D + 1)(q^{D-1} - 1)(q^{D-2} - 1) > 0$ . Therefore,

$$(\alpha q^{D-2} - 2)^2 > q^{2D-4}(\alpha^2 - 4q^{D+1}).$$

Furthermore,  $\alpha q^{D-2} - 2 > 0$  implies

$$\alpha q^{D-2} - 2 > q^{D-2} \sqrt{\alpha^2 - 4q^{D+1}},$$

and the claim follows. Therefore,

$$s^* \geq \frac{\alpha - \sqrt{\alpha^2 - 4q^{D+1}}}{2q^{D+3}} > q^{-2D-1},$$

contradicting (4.1).

Next assume  $c_2 = 2$ . Abbreviate  $\beta = 1 + 2q - 2q^{D-1} - q^D$  and observe  $\beta < 0$ . By Lemma 3.18(iii) we find

$$s^* = \frac{\beta \pm \sqrt{\beta^2 + 4q^D}}{2q^{D+3}}.$$

Assume first  $s^* = (\beta - \sqrt{\beta^2 + 4q^D})/(2q^{D+3})$ . If  $\beta + 2q^2 < 0$ , then clearly  $\beta + 2q^2 < \sqrt{\beta^2 + 4q^D}$ . On the other hand, if  $\beta + 2q^2 > 0$ , then  $(\beta + 2q^2)^2 < \beta^2 + 4q^D$  again implies  $\beta + 2q^2 < \sqrt{\beta^2 + 4q^D}$ . Therefore, in both cases we find  $\beta + 2q^2 < \sqrt{\beta^2 + 4q^D}$ . But now

$$-\frac{1}{q^{D+1}} = \frac{\beta - (\beta + 2q^2)}{2q^{D+3}} > \frac{\beta - \sqrt{\beta^2 + 4q^D}}{2q^{D+3}} = s^*,$$

contradicting (4.1).

Finally, assume  $s^* = (\beta + \sqrt{\beta^2 + 4q^D})/(2q^{D+3})$ . We observe that  $q^{3D-4} + \beta q^{D-2} - 1 = (q^{D-1} - 1)^2(q^{D-2} - 1) > 0$ . Therefore  $q^{3D-4} > 1 - \beta q^{D-2}$ , implying

$$\beta^2 q^{2D-4} + 4q^{3D-4} > 4 - 4\beta q^{D-2} + \beta^2 q^{2D-4} = (2 - \beta q^{D-2})^2.$$

Taking the square root of the above inequality and dividing by  $q^{D-2}$  we obtain

$$\sqrt{\beta^2 + 4q^D} > \frac{2}{q^{D-2}} - \beta.$$

But now we have

$$s^* = \frac{\beta + \sqrt{\beta^2 + 4q^D}}{2q^{D+3}} > \frac{1}{q^{2D+1}},$$

contradicting (4.1). This finishes the proof.  $\blacksquare$

## 4.2 The partition - part I

We continue to discuss the distance-regular graph  $\Gamma = (X, \mathcal{R})$  from Chapter 3. Up to Section 4.4 we will assume that  $\Gamma$  is bipartite with diameter  $D \geq 4$ , valency  $k \geq 3$  and intersection number  $c_2 = 2$ . In this section we describe certain partition of the vertex set  $X$ .

**Definition 4.3** *Let  $\Gamma$  denote a bipartite distance-regular graph with diameter  $D \geq 4$ , valency  $k \geq 3$  and intersection number  $c_2 = 2$ . Fix vertices  $x, y \in X$  such that  $\partial(x, y) = 2$ . For all integers  $i, j$  we define  $\mathcal{D}_j^i = \mathcal{D}_j^i(x, y)$  by*

$$\mathcal{D}_j^i := \Gamma_{ij}(x, y) = \{w \in X \mid \partial(x, w) = i \text{ and } \partial(y, w) = j\}.$$

We observe  $\mathcal{D}_j^i = \emptyset$  unless  $0 \leq i, j \leq D$ . Moreover  $|\mathcal{D}_j^i| = p_{ij}^2$  for  $0 \leq i, j \leq D$ .

**Lemma 4.4** ([35, Lemma 3.2]) *With reference to Definition 4.3, the following (i), (ii) hold for  $0 \leq i, j \leq D$ .*

(i) *If  $|i - j| > 2$  then  $\mathcal{D}_j^i = \emptyset$ .*

(ii) *If  $i + j$  is odd then  $\mathcal{D}_j^i = \emptyset$ .*

**Lemma 4.5** ([35, Lemma 3.3]) *With reference to Definition 4.3, the following (i), (ii) hold.*

(i)  $|\mathcal{D}_0^2| = |\mathcal{D}_2^0| = 1$  and  $|\mathcal{D}_{i-1}^{i+1}| = |\mathcal{D}_{i+1}^{i-1}| = (b_2 b_3 \cdots b_i) / (c_1 c_2 \cdots c_{i-1})$  ( $2 \leq i \leq D - 1$ );

(ii)  $\mathcal{D}_{i-1}^{i+1} \neq \emptyset$ ,  $\mathcal{D}_{i+1}^{i-1} \neq \emptyset$  ( $1 \leq i \leq D - 1$ ).

**Lemma 4.6** ([35, Lemma 3.4]) *With reference to Definition 4.3, there are no edges inside the set  $\mathcal{D}_j^i$  for  $0 \leq i, j \leq D$ . ■*

**Lemma 4.7** *With reference to Definition 4.3, let  $z, v$  denote the common neighbours of  $x$  and  $y$ . For  $1 \leq i \leq D$  and for  $w \in \mathcal{D}_i^i$  we have  $\partial(w, z) \in \{i - 1, i + 1\}$  and  $\partial(w, v) \in \{i - 1, i + 1\}$ .*

**PROOF.** Let  $u \in \{z, v\}$ . From the triangle inequality we find  $i - 1 \leq \partial(w, u) \leq i + 1$ . Now if  $\partial(w, u) = i$ , then we have a cycle of an odd length in  $\Gamma$ , a contradiction. ■

**Definition 4.8** *Let  $\Gamma$  denote a bipartite distance-regular graph with diameter  $D \geq 4$ , valency  $k \geq 3$  and intersection number  $c_2 = 2$ . Fix vertices  $x, y \in X$  such that  $\partial(x, y) = 2$  and let  $z, v$  denote the common neighbours of  $x, y$ . For  $0 \leq i, j \leq D$  let the sets  $\mathcal{D}_j^i$  be as defined in Definition 4.3. For  $1 \leq i \leq D$  we define  $\mathcal{D}_i^i(0) = \mathcal{D}_i^i(0)(x, y)$ ,  $\mathcal{D}_i^i(2) = \mathcal{D}_i^i(2)(x, y)$ ,  $\mathcal{D}_i^i(1)' = \mathcal{D}_i^i(1)'(x, y)$ ,  $\mathcal{D}_i^i(1)'' = \mathcal{D}_i^i(1)''(x, y)$  by*

$$\mathcal{D}_i^i(0) = \{w \in \mathcal{D}_i^i \mid \partial(w, z) = i + 1 \text{ and } \partial(w, v) = i + 1\},$$

$$\mathcal{D}_i^i(2) = \{w \in \mathcal{D}_i^i \mid \partial(w, z) = i - 1 \text{ and } \partial(w, v) = i - 1\},$$

$$\mathcal{D}_i^i(1)' = \{w \in \mathcal{D}_i^i \mid \partial(w, z) = i - 1 \text{ and } \partial(w, v) = i + 1\},$$

$$\mathcal{D}_i^i(1)'' = \{w \in \mathcal{D}_i^i \mid \partial(w, z) = i + 1 \text{ and } \partial(w, v) = i - 1\}.$$

We observe  $\mathcal{D}_i^i$  is a disjoint union of  $\mathcal{D}_i^i(0), \mathcal{D}_i^i(1)', \mathcal{D}_i^i(1)'', \mathcal{D}_i^i(2)$ .

**Remark 4.9** *With reference to Definition 4.8, note that  $\partial(z, v) = 2$  and that  $x, y$  are the common neighbours of  $z, v$ . Consequently, if we have a result that holds for  $x, y$  (and  $z, v$  as their common neighbours), then an analogous result for  $z, v$  (and  $x, y$  as their common neighbours) also holds. We will be using this fact extensively throughout the chapter.*

We have a comment.

**Lemma 4.10** *With reference to Definition 4.8, the following (i)–(iii) hold.*

- (i)  $\mathcal{D}_1^1(0) = \emptyset$ ,  $\mathcal{D}_1^1(2) = \emptyset$ ,  $\mathcal{D}_1^1(1)' = \{z\}$ ,  $\mathcal{D}_1^1(1)'' = \{v\}$ .
- (ii)  $\mathcal{D}_2^2(2) = \emptyset$ .
- (iii)  $\mathcal{D}_D^D(2) = \mathcal{D}_D^D$  and  $\mathcal{D}_D^D(0) = \mathcal{D}_D^D(1)' = \mathcal{D}_D^D(1)'' = \emptyset$ .

PROOF. (i) and (iii) follows immediately from Definition 4.8. (ii) follows from the fact that  $c_2 = 2$ . ■

**Lemma 4.11** *With reference to Definition 4.8, the following (i)–(vi) hold.*

- (i)  $\mathcal{D}_{i+1}^{i-1}(x, y) = \mathcal{D}_i^i(1)'(z, v) := \{w \in \Gamma_{ii}(z, v) \mid \partial(w, x) = i - 1 \text{ and } \partial(w, y) = i + 1\}$  for  $1 \leq i \leq D - 1$ .
- (ii)  $\mathcal{D}_{i-1}^{i+1}(x, y) = \mathcal{D}_i^i(1)''(z, v) := \{w \in \Gamma_{ii}(z, v) \mid \partial(w, x) = i + 1 \text{ and } \partial(w, y) = i - 1\}$  for  $1 \leq i \leq D - 1$ .
- (iii)  $\mathcal{D}_i^i(0)(x, y) = \mathcal{D}_{i+1}^{i+1}(2)(z, v) := \{w \in \Gamma_{i+1, i+1}(z, v) \mid \partial(w, x) = i \text{ and } \partial(w, y) = i\}$  for  $1 \leq i \leq D - 1$ .
- (iv)  $\mathcal{D}_i^i(2)(x, y) = \mathcal{D}_{i-1}^{i-1}(0)(z, v) := \{w \in \Gamma_{i-1, i-1}(z, v) \mid \partial(w, x) = i \text{ and } \partial(w, y) = i\}$  for  $2 \leq i \leq D$ .
- (v)  $\mathcal{D}_i^i(1)'(x, y) = \mathcal{D}_{i+1}^{i-1}(z, v)$  for  $1 \leq i \leq D - 1$ .
- (vi)  $\mathcal{D}_i^i(1)''(x, y) = \mathcal{D}_{i-1}^{i+1}(z, v)$  for  $1 \leq i \leq D - 1$ .

PROOF. (i) Pick  $w \in \mathcal{D}_{i+1}^{i-1}(x, y)$  and note that  $\partial(w, x) = i - 1$ ,  $\partial(w, y) = i + 1$  and  $\partial(w, z) = \partial(w, v) = i$ . Therefore  $w \in \mathcal{D}_i^i(1)'(z, v)$ , implying  $\mathcal{D}_{i+1}^{i-1}(x, y) \subseteq \mathcal{D}_i^i(1)'(z, v)$ . Similarly, if  $w \in \mathcal{D}_i^i(1)'(z, v)$ , then  $\partial(w, z) = \partial(w, v) = i$ ,  $\partial(w, x) = i - 1$  and  $\partial(w, y) = i + 1$ . Therefore  $w \in \mathcal{D}_{i+1}^{i-1}(x, y)$ , implying  $\mathcal{D}_i^i(1)'(z, v) \subseteq \mathcal{D}_{i+1}^{i-1}(x, y)$ . The result follows.

(ii)–(vi) Similarly as the proof of (i) above. ■

To compute the cardinalities of the sets  $\mathcal{D}_i^i(0)$ ,  $\mathcal{D}_i^i(1)'$ ,  $\mathcal{D}_i^i(1)''$  and  $\mathcal{D}_i^i(2)$  we make the following definition. For  $2 \leq i \leq D - 1$  define

$$M_i = p_{ii}^2 - p_{i-1, i-1}^2 + p_{i-2, i-2}^2 - \cdots \pm p_{22}^2$$

and

$$N_i = p_{i-1, i+1}^2 - p_{i-2, i}^2 + p_{i-3, i-1}^2 - \cdots \pm p_{13}^2.$$

**Lemma 4.12** *With reference to Definition 4.8, the following (i)–(iv) hold.*

- (i)  $|\mathcal{D}_i^i(1)'| = p_{i-1, i+1}^2$  ( $1 \leq i \leq D - 1$ );
- (ii)  $|\mathcal{D}_i^i(1)''| = p_{i-1, i+1}^2$  ( $1 \leq i \leq D - 1$ );
- (iii)  $|\mathcal{D}_i^i(0)| = M_i - 2N_i$  ( $2 \leq i \leq D - 1$ );
- (iv)  $|\mathcal{D}_i^i(2)| = M_{i-1} - 2N_{i-1}$  ( $3 \leq i \leq D$ );

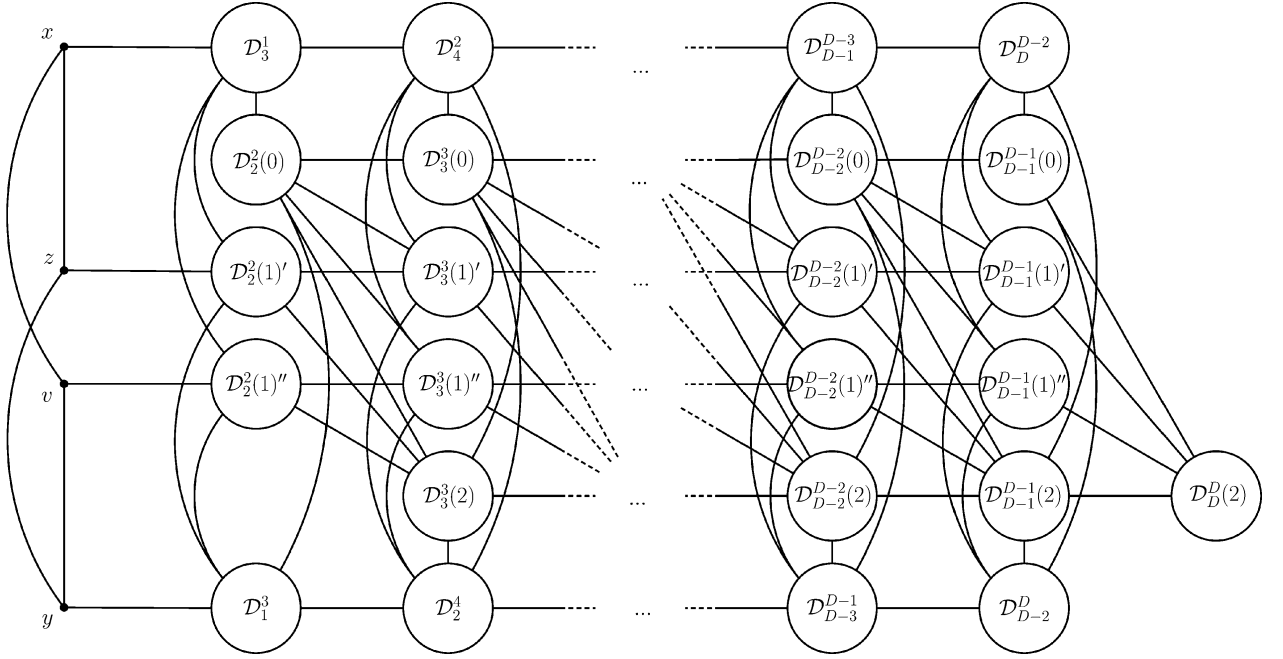

**Figure 4.1.** The partition of graph  $\Gamma$  with respect to  $x \in X$ ,  $y \in \Gamma_2(x)$  and  $z, v \in \Gamma_{11}(x, y)$ .

PROOF. (i), (ii) This follows from Lemma 4.11(v),(vi) and Lemma 4.5.

(iii) As  $|\mathcal{D}_2^2(1)' \cup \mathcal{D}_2^2(1)'' \cup \mathcal{D}_2^2(0)| = p_{22}^2$ , the result is true for  $i = 2$ . Now assume that the result is true for some  $i$  ( $2 \leq i \leq D - 2$ ). We will show that it is true also for  $i + 1$ . Note that  $\mathcal{D}_{i+1}^{i+1}$  is a disjoint union of  $\mathcal{D}_{i+1}^{i+1}(0)$ ,  $\mathcal{D}_{i+1}^{i+1}(1)'$ ,  $\mathcal{D}_{i+1}^{i+1}(1)''$  and  $\mathcal{D}_{i+1}^{i+1}(2)$ . It follows from (i), (ii) above, Lemma 4.11(iv) and the induction hypothesis that  $|\mathcal{D}_{i+1}^{i+1}(0)| = p_{i+1, i+1}^2 - 2p_{i, i+2}^2 - M_i + 2N_i$ . The result follows.

(iv) The result follows from (iii) above and Lemma 4.11(iv).  $\blacksquare$

**Corollary 4.13** *With reference to Definition 4.8, the following (i), (ii) hold.*

- (i)  $\mathcal{D}_i^i(1)' \neq \emptyset$  ( $1 \leq i \leq D - 1$ );
- (ii)  $\mathcal{D}_i^i(1)'' \neq \emptyset$  ( $1 \leq i \leq D - 1$ );

PROOF. Immediate from Lemma 4.12(i),(ii).  $\blacksquare$

**Lemma 4.14** *With reference to Definition 4.8, the following (i)–(iv) hold.*

- (i) For  $1 \leq i \leq D - 1$ , there is no edge between any of the sets  $\mathcal{D}_i^i(0)$ ,  $\mathcal{D}_i^i(1)'$ ,  $\mathcal{D}_i^i(1)''$ ,  $\mathcal{D}_i^i(2)$ .
- (ii) For  $2 \leq i \leq D - 1$ , there is no edge between  $\mathcal{D}_i^i(0)$  and  $\mathcal{D}_{i-1}^{i-1}(1)' \cup \mathcal{D}_{i-1}^{i-1}(1)'' \cup \mathcal{D}_{i-1}^{i-1}(2)$ .
- (iii) For  $2 \leq i \leq D - 1$ , there is no edge between  $\mathcal{D}_i^i(1)'$  and  $\mathcal{D}_{i-1}^{i-1}(1)'' \cup \mathcal{D}_{i-1}^{i-1}(2)$ .
- (iv) For  $2 \leq i \leq D - 1$ , there is no edge between  $\mathcal{D}_i^i(1)''$  and  $\mathcal{D}_{i-1}^{i-1}(1)' \cup \mathcal{D}_{i-1}^{i-1}(2)$ .

PROOF. (i) Immediate from Lemma 4.6.

(ii), (iii), (iv) By the definition of the sets  $\mathcal{D}_i^i(0)$ ,  $\mathcal{D}_i^i(1)'$ ,  $\mathcal{D}_i^i(1)''$ ,  $\mathcal{D}_i^i(2)$ .  $\blacksquare$

With reference to Definition 4.8, we visualize  $\mathcal{D}_{i+1}^{i+1}$ ,  $\mathcal{D}_{i-1}^{i-1}$ ,  $\mathcal{D}_i^i(0)$ ,  $\mathcal{D}_i^i(1)'$ ,  $\mathcal{D}_i^i(1)''$ ,  $\mathcal{D}_i^i(2)$  and edges between these sets in Figure 1.

**Lemma 4.15** *With reference to Definition 4.8, the following holds. For each integer  $i$  ( $1 \leq i \leq D - 1$ ), each  $w \in \mathcal{D}_{i-1}^{i+1}$  (resp.  $\mathcal{D}_{i+1}^{i-1}$ ) is adjacent to*

- (a) *precisely  $c_{i-1}$  vertices in  $\mathcal{D}_{i-2}^i$  (resp.  $\mathcal{D}_i^{i-2}$ ),*
  - (b) *precisely  $b_{i+1}$  vertices in  $\mathcal{D}_i^{i+2}$  (resp.  $\mathcal{D}_{i+2}^i$ ),*
  - (c) *precisely  $c_i - c_{i-1} - |\Gamma(w) \cap \mathcal{D}_i^i(2)|$  vertices in  $\mathcal{D}_i^i(1)'$ ,*
  - (d) *precisely  $c_i - c_{i-1} - |\Gamma(w) \cap \mathcal{D}_i^i(2)|$  vertices in  $\mathcal{D}_i^i(1)''$ ,*
  - (e) *precisely  $b_i - b_{i+1} - c_i + c_{i-1} + |\Gamma(w) \cap \mathcal{D}_i^i(2)|$  vertices in  $\mathcal{D}_i^i(0)$ ,*
  - (f) *precisely  $|\Gamma(w) \cap \mathcal{D}_i^i(2)|$  vertices in  $\mathcal{D}_i^i(2)$ ,*
- and no other vertices in  $X$ .*

PROOF. The proof of (a), (b) and (f) is a routine. We now prove (c). We prove (c) for the case  $w \in \mathcal{D}_{i-1}^{i+1}$ . The case  $w \in \mathcal{D}_{i+1}^{i-1}$  is treated similarly. First note that  $w$  is at distance  $i$  from  $z$ , and so  $w$  must have  $c_i$  neighbours in  $\Gamma_{i-1}(z)$ . Observe also that  $\Gamma_{i-1}(z) = \mathcal{D}_{i-2}^i \cup \mathcal{D}_i^{i-2} \cup \mathcal{D}_i^i(1)' \cup \mathcal{D}_i^i(2) \cup \mathcal{D}_{i-2}^{i-2}(0) \cup \mathcal{D}_{i-2}^{i-2}(1)''$ . As  $w$  only can have neighbours in  $\mathcal{D}_{i-2}^i \cup \mathcal{D}_i^i(1)' \cup \mathcal{D}_i^i(2)$ , the result follows from (a) above. The proof of (d) is similar, and the proof of (e) is clear as  $w$  must have  $k$  neighbours. ■

**Lemma 4.16** *With reference to Definition 4.8, the following (i), (ii) hold.*

- (i) *Vertex  $v$  (resp.  $z$ ) is adjacent to precisely one neighbour in  $\mathcal{D}_2^0$ , precisely one neighbour in  $\mathcal{D}_0^2$ , precisely  $b_2 = k - 2$  neighbours in  $\mathcal{D}_2^2(1)''$  (resp.  $\mathcal{D}_2^2(1)'$ ), and no other vertices in  $X$ .*
- (ii) *For each integer  $i$  ( $2 \leq i \leq D - 1$ ), each  $w \in \mathcal{D}_i^i(1)''$  (resp.  $\mathcal{D}_i^i(1)'$ ) is adjacent to*
  - (a) *precisely  $c_{i-1}$  vertices in  $\mathcal{D}_{i-1}^{i-1}(1)''$  (resp.  $\mathcal{D}_{i-1}^{i-1}(1)'$ ),*
  - (b) *precisely  $b_{i+1}$  vertices in  $\mathcal{D}_{i+1}^{i+1}(1)''$  (resp.  $\mathcal{D}_{i+1}^{i+1}(1)'$ ),*
  - (c) *precisely  $c_i - c_{i-1} - |\Gamma(w) \cap \mathcal{D}_{i-1}^{i-1}(0)|$  vertices in  $\mathcal{D}_{i+1}^{i-1}$ ,*
  - (d) *precisely  $c_i - c_{i-1} - |\Gamma(w) \cap \mathcal{D}_{i-1}^{i-1}(0)|$  vertices in  $\mathcal{D}_{i-1}^{i+1}$ ,*
  - (e) *precisely  $b_i - b_{i+1} - c_i + c_{i-1} + |\Gamma(w) \cap \mathcal{D}_{i-1}^{i-1}(0)|$  vertices in  $\mathcal{D}_{i+1}^{i+1}(2)$ ,*
  - (f) *precisely  $|\Gamma(w) \cap \mathcal{D}_{i-1}^{i-1}(0)|$  vertices in  $\mathcal{D}_{i-1}^{i-1}(0)$ ,**and no other vertices in  $X$ .*

PROOF. (i) This is clear.

(ii) This follows from Lemma 4.11 and Lemma 4.15. ■

**Lemma 4.17** *With reference to Definition 4.8, the following holds. For each integer  $i$  ( $2 \leq i \leq D - 1$ ), each  $w \in \mathcal{D}_i^i(0)$  is adjacent to*

- (a) *precisely  $|\Gamma(w) \cap \mathcal{D}_{i-1}^{i-1}(0)|$  vertices in  $\mathcal{D}_{i-1}^{i-1}(0)$ ,*
  - (b) *precisely  $c_i - |\Gamma(w) \cap \mathcal{D}_{i-1}^{i-1}(0)|$  vertices in  $\mathcal{D}_{i-1}^{i+1}$ ,*
  - (c) *precisely  $c_i - |\Gamma(w) \cap \mathcal{D}_{i-1}^{i-1}(0)|$  vertices in  $\mathcal{D}_{i+1}^{i-1}$ ,*
  - (d) *precisely  $|\Gamma(w) \cap \mathcal{D}_{i+1}^{i+1}(0)|$  vertices in  $\mathcal{D}_{i+1}^{i+1}(0)$ ,*
  - (e) *precisely  $b_{i+1} - |\Gamma(w) \cap \mathcal{D}_{i+1}^{i+1}(0)|$  vertices in  $\mathcal{D}_{i+1}^{i+1}(1)''$ ,*
  - (f) *precisely  $b_{i+1} - |\Gamma(w) \cap \mathcal{D}_{i+1}^{i+1}(0)|$  vertices in  $\mathcal{D}_{i+1}^{i+1}(1)'$ ,*
  - (g) *precisely  $k - 2c_i - 2b_{i+1} + |\Gamma(w) \cap \mathcal{D}_{i-1}^{i-1}(0)| + |\Gamma(w) \cap \mathcal{D}_{i+1}^{i+1}(0)|$  vertices in  $\mathcal{D}_{i+1}^{i+1}(2)$ ,*
- and no other vertices in  $X$ .*

PROOF. The proof of (a) and (d) is a routine. The proof of (b) (resp. (c)) follows from the fact that  $\partial(w, x) = \partial(w, y) = i$ , and so  $w$  must have  $c_i$  neighbours in  $\Gamma_{i-1}(x)$  (resp.  $\Gamma_{i-1}(y)$ ). We now prove (e). First note that  $w$  is at distance  $i + 1$  from  $v$ , and so  $w$  must have  $b_{i+1}$  neighbours in  $\Gamma_{i+2}(v)$ . As  $\Gamma_{i+2}(v) \cap \Gamma(w) \subseteq \mathcal{D}_{i+1}^{i+1}(0) \cup \mathcal{D}_{i+1}^{i+1}(1)'$ , the result follows from (d) above. The proof of (f) is similar, and the proof of (g) is clear as  $w$  must have  $k$  neighbours. ■

**Lemma 4.18** *With reference to Definition 4.8, the following holds. For each integer  $i$  ( $3 \leq i \leq D$ ), each  $w \in \mathcal{D}_i^i(2)$  is adjacent to*

- (a) *precisely  $|\Gamma(w) \cap \mathcal{D}_{i-1}^{i-1}(2)|$  vertices in  $\mathcal{D}_{i-1}^{i-1}(2)$ ,*
- (b) *precisely  $c_{i-1} - |\Gamma(w) \cap \mathcal{D}_{i-1}^{i-1}(2)|$  vertices in  $\mathcal{D}_{i-1}^{i-1}(1)''$ ,*
- (c) *precisely  $c_{i-1} - |\Gamma(w) \cap \mathcal{D}_{i-1}^{i-1}(2)|$  vertices in  $\mathcal{D}_{i-1}^{i-1}(1)'$ ,*
- (d) *precisely  $|\Gamma(w) \cap \mathcal{D}_{i+1}^{i+1}(2)|$  vertices in  $\mathcal{D}_{i+1}^{i+1}(2)$ ,*
- (e) *precisely  $b_i - |\Gamma(w) \cap \mathcal{D}_{i+1}^{i+1}(2)|$  vertices in  $\mathcal{D}_{i-1}^{i+1}$ ,*
- (f) *precisely  $b_i - |\Gamma(w) \cap \mathcal{D}_{i+1}^{i+1}(2)|$  vertices in  $\mathcal{D}_{i+1}^{i-1}$ ,*
- (g) *precisely  $k - 2b_i - 2c_{i-1} + |\Gamma(w) \cap \mathcal{D}_{i+1}^{i+1}(2)| + |\Gamma(w) \cap \mathcal{D}_{i-1}^{i-1}(2)|$  vertices in  $\mathcal{D}_{i-1}^{i-1}(0)$ ,*  
*and no other vertices in  $X$ .*

PROOF. This follows from Lemma 4.11 and Lemma 4.17. ■

### 4.3 The partition - part II

We continue to discuss the distance-regular graph  $\Gamma = (X, \mathcal{R})$  from Section 4.2. In this section we further assume  $\Gamma$  is  $Q$ -polynomial. We show the partition from Section 4.2 is equitable, and that the corresponding parameters are independent of  $x, y$ .

**Lemma 4.19** *With reference to Definition 4.8, let  $E$  denote a nontrivial primitive idempotent of  $\Gamma$  and let  $\{\theta_i^*\}_{i=0}^D$  denote the corresponding dual eigenvalue sequence. Assume  $\Gamma$  is  $Q$ -polynomial with respect to  $E$ . Then for  $1 \leq i \leq D-1$  and for  $w \in \mathcal{D}_{i-1}^{i+1} \cup \mathcal{D}_{i+1}^{i-1}$ ,*

$$|\Gamma(w) \cap \mathcal{D}_i^i(2)| = c_i \frac{(\theta_0^* - \theta_i^*)(\theta_3^* - \theta_{i+1}^*) - (\theta_1^* - \theta_{i-1}^*)(\theta_2^* - \theta_i^*)}{(\theta_0^* - \theta_i^*)(\theta_{i-1}^* - \theta_{i+1}^*)} - c_{i-1} + \frac{\theta_1^* - \theta_3^*}{\theta_{i-1}^* - \theta_{i+1}^*}.$$

PROOF. Assume  $w \in \mathcal{D}_{i-1}^{i+1}$ . If  $w \in \mathcal{D}_{i+1}^{i-1}$ , then the proof is similar. We abbreviate  $\tau = |\Gamma(w) \cap \mathcal{D}_i^i(2)|$ . By Theorem 3.17 we find

$$\sum_{\substack{u \in X \\ \partial(u,v)=i-1 \\ \partial(u,w)=1}} E\hat{u} - \sum_{\substack{u \in X \\ \partial(u,v)=1 \\ \partial(u,w)=i-1}} E\hat{u} = c_i \frac{\theta_{i-1}^* - \theta_1^*}{\theta_0^* - \theta_i^*} (E\hat{v} - E\hat{w}). \quad (4.2)$$

Observe that beside  $y$ , all vertices of the set  $\{u \in X \mid \partial(u,v) = 1, \partial(u,w) = i-1\}$  are contained in  $\mathcal{D}_2^2(1)''$ . On the other hand, vertices of the set  $\{u \in X \mid \partial(u,v) = i-1, \partial(u,w) = 1\}$  are contained in  $\mathcal{D}_{i-2}^i$  (there is  $c_{i-1}$  of these vertices and all are at distance  $i-1$  from  $z$ ), in  $\mathcal{D}_i^i(2)$  (there is  $\tau$  of these vertices and all are at distance  $i-1$  from  $z$ ), and in  $\mathcal{D}_i^i(1)''$  (there is  $c_i - c_{i-1} - \tau$  of these vertices and all are at distance  $i+1$  from  $z$ ). Taking the inner product of (4.2) with  $E\hat{z}$ , using Lemma 3.13 and the above comments, we get (after multiplying by  $|\Gamma|$ )

$$c_{i-1}\theta_{i-1}^* + \tau\theta_{i-1}^* + (c_i - c_{i-1} - \tau)\theta_{i+1}^* - \theta_1^* - (c_i - 1)\theta_3^* = c_i \frac{\theta_{i-1}^* - \theta_1^*}{\theta_0^* - \theta_i^*} (\theta_2^* - \theta_i^*).$$

Evaluating the above line using  $\theta_{i-1}^* \neq \theta_{i+1}^*$  we obtain

$$\tau = c_i \frac{(\theta_0^* - \theta_i^*)(\theta_3^* - \theta_{i+1}^*) - (\theta_1^* - \theta_{i-1}^*)(\theta_2^* - \theta_i^*)}{(\theta_0^* - \theta_i^*)(\theta_{i-1}^* - \theta_{i+1}^*)} - c_{i-1} + \frac{\theta_1^* - \theta_3^*}{\theta_{i-1}^* - \theta_{i+1}^*}.$$

The assertion now follows. ■

**Lemma 4.20** *With reference to Definition 4.8, let  $E$  denote a nontrivial primitive idempotent of  $\Gamma$  and let  $\{\theta_i^*\}_{i=0}^D$  denote the corresponding dual eigenvalue sequence. Assume  $\Gamma$  is  $Q$ -polynomial with respect to  $E$ . Then for  $2 \leq i \leq D-1$  and for  $w \in \mathcal{D}_i^i(1)' \cup \mathcal{D}_i^i(1)''$ ,*

$$|\Gamma(w) \cap \mathcal{D}_{i-1}^{i-1}(0)| = c_i \frac{(\theta_0^* - \theta_i^*)(\theta_3^* - \theta_{i+1}^*) - (\theta_1^* - \theta_{i-1}^*)(\theta_2^* - \theta_i^*)}{(\theta_0^* - \theta_i^*)(\theta_{i-1}^* - \theta_{i+1}^*)} - c_{i-1} + \frac{\theta_1^* - \theta_3^*}{\theta_{i-1}^* - \theta_{i+1}^*}.$$



PROOF. This follows from Lemma 4.11 and Lemma 4.19.  $\blacksquare$

**Lemma 4.21** *With reference to Definition 4.8, let  $E$  denote a nontrivial primitive idempotent of  $\Gamma$  and let  $\{\theta_i^*\}_{i=0}^D$  denote the corresponding dual eigenvalue sequence. Assume  $\Gamma$  is  $Q$ -polynomial with respect to  $E$ . Then for  $2 \leq i \leq D-1$  and for  $w \in \mathcal{D}_i^i(0)$  the following (i), (ii) hold.*

(i)

$$|\Gamma(w) \cap \mathcal{D}_{i-1}^{i-1}(0)| = c_i \frac{(\theta_0^* - \theta_i^*)(\theta_3^* - \theta_{i+1}^*) - (\theta_1^* - \theta_{i-1}^*)(\theta_2^* - \theta_i^*)}{(\theta_0^* - \theta_i^*)(\theta_{i-1}^* - \theta_{i+1}^*)}.$$

(ii)

$$|\Gamma(w) \cap \mathcal{D}_{i+1}^{i+1}(0)| = b_{i+1} \frac{(\theta_0^* - \theta_{i+1}^*)(\theta_3^* - \theta_i^*) - (\theta_1^* - \theta_{i+2}^*)(\theta_2^* - \theta_{i+1}^*)}{(\theta_0^* - \theta_{i+1}^*)(\theta_{i+2}^* - \theta_i^*)}.$$

PROOF. (i) We abbreviate  $\tau = |\Gamma(w) \cap \mathcal{D}_{i-1}^{i-1}(0)|$ . By Theorem 3.17 we find

$$\sum_{\substack{u \in X \\ \partial(u,x)=i-1 \\ \partial(u,w)=1}} E\hat{u} - \sum_{\substack{u \in X \\ \partial(u,x)=1 \\ \partial(u,w)=i-1}} E\hat{u} = c_i \frac{\theta_{i-1}^* - \theta_1^*}{\theta_0^* - \theta_i^*} (E\hat{x} - E\hat{w}). \quad (4.3)$$

Observe that all vertices of the set  $\{u \in X \mid \partial(u,x) = 1, \partial(u,w) = i-1\}$  are contained in  $\mathcal{D}_3^1$ . On the other hand, vertices of the set  $\{u \in X \mid \partial(u,x) = i-1, \partial(u,w) = 1\}$  are contained in  $\mathcal{D}_{i-1}^{i-1}(0)$  (there is  $\tau$  of these vertices and all are at distance  $i-1$  from  $y$ ), and in  $\mathcal{D}_{i+1}^{i-1}$  (there is  $c_i - \tau$  of these vertices and all are at distance  $i+1$  from  $y$ ). Taking the inner product of (4.3) with  $E\hat{y}$ , using Lemma 3.13 and the above comments, we get (after multiplying by  $|\Gamma|$ )

$$\tau\theta_{i-1}^* + (c_i - \tau)\theta_{i+1}^* - c_i\theta_3^* = c_i \frac{\theta_{i-1}^* - \theta_1^*}{\theta_0^* - \theta_i^*} (\theta_2^* - \theta_i^*).$$

Evaluating the above line using  $\theta_{i-1}^* \neq \theta_{i+1}^*$  we obtain

$$\tau = c_i \frac{(\theta_0^* - \theta_i^*)(\theta_3^* - \theta_{i+1}^*) - (\theta_1^* - \theta_{i-1}^*)(\theta_2^* - \theta_i^*)}{(\theta_0^* - \theta_i^*)(\theta_{i-1}^* - \theta_{i+1}^*)}.$$

The assertion now follows.

(ii) We abbreviate  $\tau = |\Gamma(w) \cap \mathcal{D}_{i+1}^{i+1}(0)|$ . By Theorem 3.17 we find

$$\sum_{\substack{u \in X \\ \partial(u,v)=i+2 \\ \partial(u,w)=1}} E\hat{u} - \sum_{\substack{u \in X \\ \partial(u,v)=1 \\ \partial(u,w)=i+2}} E\hat{u} = b_{i+1} \frac{\theta_{i+2}^* - \theta_1^*}{\theta_0^* - \theta_{i+1}^*} (E\hat{v} - E\hat{w}). \quad (4.4)$$

Observe that all vertices of the set  $\{u \in X \mid \partial(u,v) = 1, \partial(u,w) = i+2\}$  are contained in  $\mathcal{D}_2^2(1)''$ . On the other hand, vertices of the set  $\{u \in X \mid \partial(u,v) = i+2, \partial(u,w) = 1\}$  are contained in  $\mathcal{D}_{i+1}^{i+1}(0)$  (there is  $\tau$  of these vertices and all are at distance  $i+2$  from  $z$ ), and in  $\mathcal{D}_{i+1}^{i+1}(1)'$  (there is  $b_{i+1} - \tau$  of these vertices and all are at distance  $i$  from  $z$ ). Taking the inner product of (4.4) with  $E\hat{z}$ , using Lemma 3.13 and the above comments, we get (after multiplying by  $|\Gamma|$ )

$$\tau\theta_{i+2}^* + (b_{i+1} - \tau)\theta_i^* - b_{i+1}\theta_3^* = b_{i+1} \frac{\theta_{i+2}^* - \theta_1^*}{\theta_0^* - \theta_{i+1}^*} (\theta_2^* - \theta_{i+1}^*).$$

Evaluating the above line using  $\theta_i^* \neq \theta_{i+2}^*$  we obtain

$$\tau = b_{i+1} \frac{(\theta_0^* - \theta_{i+1}^*)(\theta_3^* - \theta_i^*) - (\theta_1^* - \theta_{i+2}^*)(\theta_2^* - \theta_{i+1}^*)}{(\theta_0^* - \theta_{i+1}^*)(\theta_{i+2}^* - \theta_i^*)}.$$

The assertion now follows.  $\blacksquare$



**Lemma 4.22** *With reference to Definition 4.8, let  $E$  denote a nontrivial primitive idempotent of  $\Gamma$  and let  $\{\theta_i^*\}_{i=0}^D$  denote the corresponding dual eigenvalue sequence. Assume  $\Gamma$  is  $Q$ -polynomial with respect to  $E$ . Then for  $3 \leq i \leq D$  and for  $w \in \mathcal{D}_i^i(2)$  the following (i), (ii) hold.*

(i)

$$|\Gamma(w) \cap \mathcal{D}_{i-1}^{i-1}(2)| = c_{i-1} \frac{(\theta_0^* - \theta_{i-1}^*)(\theta_3^* - \theta_i^*) - (\theta_1^* - \theta_{i-2}^*)(\theta_2^* - \theta_{i-1}^*)}{(\theta_0^* - \theta_{i-1}^*)(\theta_{i-2}^* - \theta_i^*)}.$$

(ii)

$$|\Gamma(w) \cap \mathcal{D}_{i+1}^{i+1}(2)| = b_i \frac{(\theta_0^* - \theta_i^*)(\theta_3^* - \theta_{i-1}^*) - (\theta_1^* - \theta_{i+1}^*)(\theta_2^* - \theta_i^*)}{(\theta_0^* - \theta_i^*)(\theta_{i+1}^* - \theta_{i-1}^*)},$$

where  $\mathcal{D}_{D+1}^{D+1}(2) = \emptyset$ .

PROOF. This follows from Lemma 4.11 and Lemma 4.21. ■

**Theorem 4.23** *Let  $\Gamma$  denote a  $Q$ -polynomial bipartite distance-regular graph with diameter  $D \geq 3$ , valency  $k \geq 3$  and intersection number  $c_2 = 2$ . Then with reference to Definition 4.8, the partition of  $V\Gamma$  into nonempty sets  $\mathcal{D}_{i+1}^{i-1}, \mathcal{D}_{i-1}^{i+1}$  ( $1 \leq i \leq D-1$ ),  $\mathcal{D}_i^i(0)$  ( $2 \leq i \leq D-1$ ),  $\mathcal{D}_i^i(1)', \mathcal{D}_i^i(1)''$  ( $1 \leq i \leq D-1$ ) and  $\mathcal{D}_i^i(2)$  ( $3 \leq i \leq D$ ) is equitable. Moreover the corresponding parameters are independent of  $x, y$ .*

PROOF. Immediate from Lemma 4.15, Lemma 4.16, Lemma 4.17, Lemma 4.18, Lemma 4.19, Lemma 4.20, Lemma 4.21, and Lemma 4.22. ■

## 4.4 The case $D = 4$

In this section we consider  $Q$ -polynomial bipartite distance-regular graph  $\Gamma$  with intersection number  $c_2 \leq 2$ , valency  $k \geq 3$  and diameter  $D = 4$ . We show that  $\Gamma$  is either the 4-dimensional hypercube, or the antipodal quotient of the 8-dimensional hypercube. For the case  $c_2 = 1$  we have the following result.

**Theorem 4.24** ([35, Theorem 6.1]) *There does not exist a  $Q$ -polynomial bipartite distance-regular graph with diameter  $D = 4$ , valency  $k \geq 3$  and intersection number  $c_2 = 1$ .*

From now on we assume  $c_2 = 2$ .

**Lemma 4.25** *Let  $\Gamma$  denote a  $Q$ -polynomial bipartite distance-regular graph with diameter  $D = 4$ , valency  $k \geq 3$  and intersection number  $c_2 = 2$ . With reference to Definition 4.8 the following (i), (ii) hold.*

(i)  $|\mathcal{D}_2^2(0)| = (k-2)(c_3-3)/2;$

(ii)  $c_3 \geq 4$  if and only if  $\mathcal{D}_2^2(0) \neq \emptyset$ .

PROOF. (i) Immediately from Lemma 4.12(iii) and Lemma 3.7(v).

(ii) Immediately from (i) above. ■

**Lemma 4.26** *Let  $\Gamma$  denote a  $Q$ -polynomial bipartite distance-regular graph with diameter  $D = 4$  and intersection numbers  $c_2 = 2$ ,  $k \geq c_3 \geq 4$ . Assume  $\Gamma$  is not the 4-dimensional hypercube or the antipodal quotient of the 8-dimensional hypercube. With reference to Definition 4.8, pick  $w \in \mathcal{D}_2^2(0)$  and let  $\lambda$  denote the number of neighbours of  $w$  in  $\mathcal{D}_3^3(0)$ . Then the following (i), (ii) hold.*

(i)

$$\lambda = \frac{(k-2)b_3(b_3-1)}{(k-2)(k-3) - 2b_3}.$$

(ii)  $(k-2)(k-3) - 2b_3$  divides  $(k-2)b_3(b_3-1)$ .PROOF. (i) Let scalars  $s^*, q$  be as in Lemma 3.18. First note that by Lemma 3.18(iii) we have

$$c_2 - 2 = -\frac{(q-1)(q^{10}(s^*)^2 + s^*(q^7 + 2q^6 - 2q^4 - q^3) - 1)}{(1 - s^*q^5)(1 - s^*q^6)},$$

which implies

$$h(q, s^*) = q^{10}(s^*)^2 + s^*(q^7 + 2q^6 - 2q^4 - q^3) - 1 = 0. \quad (4.5)$$

By Lemma 4.21 we have

$$\lambda = b_3 \frac{(\theta_0^* - \theta_3^*)(\theta_3^* - \theta_2^*) - (\theta_1^* - \theta_4^*)(\theta_2^* - \theta_3^*)}{(\theta_0^* - \theta_3^*)(\theta_4^* - \theta_2^*)},$$

and by Lemma 3.18(ii),(iii) we find

$$\lambda = \frac{q^3(1 - s^*q^3)(1 - s^*q^5)}{(1 - s^*q^7)^2}. \quad (4.6)$$

Consider now the number

$$\frac{\lambda(k^2 - 5k + 4)}{b_3 - 1} - \frac{\lambda(k^2 - 5k + 6)}{b_3} - k + 2. \quad (4.7)$$

Note that  $b_3 \neq 1$ . Indeed, if  $b_3 = 1$ , then by Lemma 3.18(i),(iii) we have  $s^*q^5 = -1$ , and so  $c_2 = (q^2 + 1)^2 / (2q^2)$ . But now  $c_2 = 2$  implies  $q = \pm 1$ , a contradiction. Using Lemma 3.18 we find that (4.7) is equal to

$$\alpha \cdot (q^{10}(s^*)^2 + s^*(q^7 + 2q^6 - 2q^4 - q^3) - 1) = \alpha \cdot h(q, s^*),$$

where

$$\alpha = \frac{(s^*)^2(q^{12} - 2q^{11} - q^{10}) + s^*(q^9 + q^8 + q^7 - 2q^6 + q^5 + q^4 + q^3) - q^2 - 2q + 1}{(1 - s^*q^4)(1 + s^*q^5)(1 - s^*q^6)(1 - s^*q^7)}.$$

By (4.5) we therefore have

$$\lambda = \frac{(k-2)b_3(b_3-1)}{(k-2)(k-3) - 2b_3}.$$

(ii) This follows immediately from (i) above. ■

**Lemma 4.27** *Let  $\Gamma$  denote a  $Q$ -polynomial bipartite distance-regular graph with diameter  $D = 4$  and intersection numbers  $c_2 = 2$ ,  $k \geq c_3 \geq 4$ . Assume  $\Gamma$  is not the 4-dimensional hypercube or the antipodal quotient of the 8-dimensional hypercube. With reference to Definition 4.8, let  $\lambda$  be as in Lemma 4.26. Then the following (i), (ii) hold.*

(i) Each vertex in  $\mathcal{D}_3^3(1)''$  has exactly

$$\frac{(c_3 - 3)(b_3 - \lambda)}{b_3}$$

neighbours in  $\mathcal{D}_2^2(0)$ .

(ii)  $(k-2)(k-3) - 2b_3$  divides  $(k-4)b_3(b_3-1)$ .

PROOF. (i) By Lemma 4.12(ii),(iii) and Lemma 3.7 we find

$$|\mathcal{D}_2^2(0)| = \frac{(k-2)(c_3-3)}{2}, \quad |\mathcal{D}_3^3(1)''| = \frac{b_3(k-2)}{2}.$$

By Lemma 4.17(e), every vertex from  $\mathcal{D}_2^2(0)$  has  $b_3 - \lambda$  neighbours in  $\mathcal{D}_3^3(1)''$ . The result follows from the above comments and by counting the edges between  $\mathcal{D}_2^2(0)$  and  $\mathcal{D}_3^3(1)''$  in two different ways.

(ii) Consider the number  $(c_3-3)(b_3-\lambda)/b_3$ . Observe that, by Lemma 4.26(i), we have

$$\frac{(c_3-3)(b_3-\lambda)}{b_3} = k - 2b_3 - 2 + \frac{b_3(b_3-1)(k-4)}{(k-2)(k-3) - 2b_3}.$$

As  $(c_3-3)(b_3-\lambda)/b_3$  is integer by (i) above, the result follows.  $\blacksquare$

**Lemma 4.28** *Let  $\Gamma$  denote a  $Q$ -polynomial bipartite distance-regular graph with diameter  $D = 4$  and intersection numbers  $c_2 = 2$ ,  $k \geq c_3 \geq 4$ . Assume  $\Gamma$  is not the 4-dimensional hypercube or the antipodal quotient of the 8-dimensional hypercube. Let  $\lambda$  be as in Lemma 4.26. Then the following (i)-(iii) hold.*

(i)  $(k-2)(k-3) - 2b_3$  divides  $2b_3(b_3-1)$ ;

(ii)  $(k-2)(k-3) = 2b_3^2$ ;

(iii)  $\lambda = (k-2)/2$ .

PROOF. (i) Immediately from Lemma 4.26(ii) and Lemma 4.27(ii).

(ii) It follows from (i) above that  $2b_3(b_3-1) = \ell((k-2)(k-3) - 2b_3)$  for some nonnegative integer  $\ell$ . We will show that  $\ell = 1$ . If  $\ell = 0$ , then  $b_3 = 1$ . By Lemma 3.18(i),(iii) we have  $s^*q^5 = -1$ , and so  $c_2 = (q^2+1)^2/(2q^2)$ . But now  $c_2 = 2$  implies  $q = \pm 1$ , a contradiction. Therefore,  $\ell \geq 1$ . Assume  $\ell \geq 2$ . Then  $2b_3(b_3-1) \geq 2((k-2)(k-3) - 2b_3)$ , which implies  $(k-2)(k-3) \leq b_3(b_3+1)$ . Recall that  $c_3 \geq 4$ , and so  $b_3 \leq k-4$ . But then  $(k-2)(k-3) \leq b_3(b_3+1) \leq (k-4)(k-3)$ , a contradiction. Therefore  $2b_3(b_3-1) = (k-2)(k-3) - 2b_3$  and the result follows.

(iii) Immediately from Lemma 4.26(i) and (ii) above.  $\blacksquare$

**Lemma 4.29** *Let  $\Gamma$  denote a  $Q$ -polynomial bipartite distance-regular graph with diameter  $D = 4$ , and intersection numbers  $c_2 = 2$ ,  $k \geq c_3 \geq 4$ . Assume  $\Gamma$  is not the 4-dimensional hypercube or the antipodal quotient of the 8-dimensional hypercube. Then the following (i), (ii) hold.*

(i)  $q = -(\sqrt{5} + 3)/2$ .

(ii)  $s^* = 72\sqrt{5} - 161$ .

PROOF. (i) Let  $\lambda$  be as in Lemma 4.26. By (4.6) and Lemma 4.28(iii), we find

$$\frac{k-2}{2} - \frac{q^3(1-s^*q^3)(1-s^*q^5)}{(1-s^*q^7)^2} = 0.$$

Observe that, by Lemma 3.18(iii), we have

$$\frac{k-2}{2} - \frac{q^3(1-s^*q^3)(1-s^*q^5)}{(1-s^*q^7)^2} = \frac{(q-1)^2(q+1)f(q, s^*)}{2(1-s^*q^6)(1-s^*q^7)^2},$$

where

$$f(q, s^*) = q^{17}(s^*)^3 + q^{10}(s^*)^2(q^4 + 2q^3 + 4q^2 + 2q + 2) - q^3 s^*(2q^4 + 2q^3 + 4q^2 + 2q + 1) - 1.$$

By Lemma 3.18 and comments above, we have  $f(q, s^*) = 0$ . Recall polynomial  $h(q, s^*)$  from (4.5). Recall also that  $h(q, s^*) = 0$ . Note that

$$f(q, s^*) = h(q, s^*)(q^7 s^* + 4q^2 + 4q + 3) - 2(q^3 s^*(2q^6 + 6q^5 + 6q^4 - 4q^2 - 4q - 1) - 2q^2 - 2q - 1).$$

As  $f(q, s^*) = h(q, s^*) = 0$ , we also have  $q^3 s^*(2q^6 + 6q^5 + 6q^4 - 4q^2 - 4q - 1) - 2q^2 - 2q - 1 = 0$ , and so

$$s^* = \frac{2q^2 + 2q + 1}{q^3(2q^6 + 6q^5 + 6q^4 - 4q^2 - 4q - 1)}. \quad (4.8)$$

Using (4.8) together with  $h(q, s^*) = 0$ , we obtain

$$-\frac{2(q-1)q^2(q+1)(q^2+q+1)^2(q^2+3q+1)}{(2q^6+6q^5+6q^4-4q^2-4q-1)^2} = 0.$$

As, by Lemma 3.18,  $q$  is real and  $|q| > 1$ , we obtain  $q = -(\sqrt{5} + 3)/2$ .

(ii) Immediately from (4.8) and (i) above. ■

**Theorem 4.30** *Let  $\Gamma$  denote a  $Q$ -polynomial bipartite distance-regular graph with diameter  $D = 4$ , valency  $k \geq 3$  and intersection number  $c_2 = 2$ . Then  $\Gamma$  is either the 4-dimensional hypercube, or the antipodal quotient of the 8-dimensional hypercube.*

PROOF. Assume first that  $c_3 \geq 4$ . Then by Lemma 4.29 we have  $q = -(\sqrt{5} + 3)/2$  and  $s^* = 72\sqrt{5} - 161$ . Lemma 3.18(iii) now implies  $k = -6$ , a contradiction. Therefore  $c_3 = 3$ . But now [12, Theorem 4.6] implies that  $\Gamma$  is either the 4-dimensional hypercube, or the antipodal quotient of the 8-dimensional hypercube. ■

We finish the chapter with the proof of our main theorem.

PROOF OF THEOREM 4.1: Immediately from Theorem 4.2, Theorem 4.24 and Theorem 4.30. ■

# Terwilliger algebra

In this chapter we recall some definitions and basic concepts. See the recent survey by E.R. Van Dam, J. H. Koolen and H. Tanaka [14] for more information.

## 5.1 Dual Bose-Mesner algebra

**Definition 5.1** Let  $\Gamma = (X, \mathcal{R})$  denote a distance-regular graph with diameter  $D$ , and fix any  $x \in X$ . For each integer  $i$  ( $0 \leq i \leq D$ ), let  $E_i^* = E_i^*(x)$  denote the diagonal matrix in  $\text{Mat}_X(\mathbb{C})$  with  $(y, y)$  entry

$$(E_i^*)_{yy} = \begin{cases} 1 & \text{if } \partial(x, y) = i, \\ 0 & \text{otherwise} \end{cases} \quad (y \in X).$$

We refer to  $E_i^*$  as the  $i$ th dual idempotent of  $\Gamma$  with respect to  $x$ . For notational convenience, set  $E_i^* = 0$  for  $i < 0$  and  $i > D$ . Subalgebra  $\mathcal{M}^* = \mathcal{M}^*(x)$  of  $\text{Mat}_X(\mathbb{C})$  generated by  $E_0^*, E_1^*, \dots, E_D^*$  is called *dual Bose-Mesner algebra with respect to  $x$* .

**Lemma 5.2** *With reference to Definition 5.1, let  $V = \mathbb{C}^{|X|}$  denote the standard module for  $X$ . We have*

$$E_i^* \hat{y} = \begin{cases} \hat{y} & \text{if } \partial(x, y) = i, \\ 0 & \text{otherwise} \end{cases} \quad (y \in X, 0 \leq i \leq D). \quad (5.1)$$

$$\sum_{i=0}^D E_i^* = I, \quad (5.2)$$

$$E_i^* E_j^* = \delta_{ij} E_i^* \quad (0 \leq i, j \leq D), \quad (5.3)$$

$$E_i^* V = \text{span}\{\hat{y} \mid y \in X, \partial(x, y) = i\} \quad (0 \leq i \leq D), \quad (5.4)$$

$$V = E_0^* V + E_1^* V + \dots + E_D^* V \quad (\text{orthogonal direct sum}), \quad (5.5)$$

$$\{E_0^*, E_1^*, \dots, E_D^*\} \text{ is a basis for } \mathcal{M}^*. \quad (5.6)$$

PROOF. Routine. ■

## 5.2 Terwilliger algebra

We recall the Terwilliger algebra of  $\Gamma$ .

**Definition 5.3** Let  $\Gamma = (X, \mathcal{R})$  denote a distance-regular graph with diameter  $D$  and fix  $x \in X$ . Let  $T = T(x)$  denote the subalgebra of  $\text{Mat}_X(\mathbb{C})$  generated by Bose-Mesner algebra  $\mathcal{M}$  and dual Bose-Mesner algebra  $\mathcal{M}^*$ . We call  $T$  the *Terwilliger algebra of  $\Gamma$  with respect to  $x$* . By a  *$T$ -module* we mean a subspace  $W$  of  $V = \mathbb{C}^{|X|}$  such that  $BW \subseteq W$  for all  $B \in T$ . Let  $W$  denote a  $T$ -module. Then  $W$  is said to be *irreducible* whenever  $W$  is nonzero and  $W$  contains no  $T$ -modules other than 0 and  $W$ .

Recall  $\mathcal{M}$  is generated by  $A$ , so  $T$  is generated by  $A$  and the dual idempotents. We observe  $T$  has finite dimension.

**Lemma 5.4** *With reference to Definition 2.9, the following (i)–(iii) hold.*

$$(i) \quad B \in T \quad \Rightarrow \quad \overline{B}^\top \in T.$$

(ii) *Let  $U$  denote a  $T$ -module. For any  $T$ -module  $W \subseteq U$ ,*

$$W^\perp = \{v \in V \mid \langle w, u \rangle = 0, \forall w \in W\}$$

*is a  $T$ -module.*

(iii) *Any  $T$ -module is an orthogonal direct sum of irreducible  $T$ -modules. In particular,  $V$  is an orthogonal direct sum of irreducible  $T$ -modules.*

PROOF. (i) Note that  $T$  is generated by symmetric real matrices  $A, E_0^*, E_1^*, \dots, E_D^*$ .

(ii) Pick  $u \in W^\perp$  and  $B \in T$ . We show that  $Bu \in W^\perp$ . Note that  $\forall w \in W, \langle w, Bu \rangle = \langle \overline{B}^\top w, u \rangle = 0$  since  $\overline{B}^\top \in T$  and  $\overline{B}^\top w \in W$ . The result follows.

(iii) This is proved by the inductin on the dimension of  $T$ -modules. If  $W$  is an irreducible  $T$ -module of  $V$  then  $V = W + W^\perp$  (orthogonal direct sum). ■

One of the main research problem is the following: What does the structure of the  $T$ -module tell us about  $\Gamma$ ?

**Definition 5.5** *With reference to Definition 5.3, let  $W, W'$  denote  $T$ -modules. By an isomorphism of  $T$ -modules from  $W$  to  $W'$  we mean an isomorphism of vector spaces  $\sigma : W \rightarrow W'$  such that  $(\sigma B - B\sigma)W = 0$  for all  $B \in T$ . The  $T$ -modules  $W, W'$  are said to be isomorphic whenever there exists an isomorphism of  $T$ -modules from  $W$  to  $W'$ . By the endpoint of  $W$  we mean  $\min\{i \mid 0 \leq i \leq D, E_i^*W \neq 0\}$ . By the diameter of  $W$  we mean  $|\{i \mid 0 \leq i \leq D, E_i^*W \neq 0\}| - 1$ . We say  $W$  is thin (with respect to  $x$ ) whenever the dimension of  $E_i^*W$  is at most 1 for all  $i$  ( $0 \leq i \leq D$ ).*

**Lemma 5.6** ([49]) *With reference to Definition 5.5, let  $W$  denote an irreducible  $T$ -module. The following (i), (ii) hold.*

(i)  *$W$  is an orthogonal direct sum of the nonvanishing spaces among  $E_0^*W, E_1^*W, \dots, E_D^*W$ .*

(ii) *If  $W$  has endpoint  $r$  and diameter  $d$ , then*

$$E_i^*W \neq \mathbf{0} \quad \text{iff} \quad r \leq i \leq r + d \quad (0 \leq i \leq D).$$

PROOF. (i) First note that  $E_i^*V$  are mutually orthogonal. This implies that  $E_i^*W$  are also mutually orthogonal since  $E_i^*W \subseteq E_i^*V$ . Now let us check that  $W = \sum_{i=0}^D E_i^*W$  holds. Note that each  $E_i^* \in T$ , and since  $W$  is a  $T$ -module, we have  $TW \subseteq W$ . This yield  $\sum_{i=0}^D E_i^*W \subseteq W$  ( $W$  is by definition vector subspace, so it is closed with respect to addition). On the other hand, if we pick  $w \in W, w = Iw = \sum_{i=0}^D E_i^*w \in \sum_{i=0}^D E_i^*W$ , which yields  $W \subseteq \sum_{i=0}^D E_i^*W$ . The result follows.

(ii) By construction,  $E_i^*W = \mathbf{0}$  for  $0 \leq i < r$  and  $E_r^*W \neq \mathbf{0}$ . To obtain a contradiction, assume that there exists  $i$  ( $r < i \leq r + d$ ) such that  $E_i^*W = \mathbf{0}$ . Define subspace  $W'$  on the following way

$$W' = E_r^*W + E_{r+1}^*W + \dots + E_{i-1}^*W.$$

Note that by construction  $W' \neq 0$  and  $\mathcal{M}^*W' \subseteq W'$ . It is not hard to show that for any  $j$  ( $0 \leq j \leq D$ ) and for any irreducible  $T$ -module  $U$  we have

$$AE_j^*U \subseteq E_{j-1}^*U + E_j^*U + E_{j+1}^*U.$$

This yields  $AW' \subseteq W'$ , so  $W'$  is  $T$ -module. Now we can conclude that  $W' = W$  by the irreducibility of  $W$ . This contradicts the diameter of  $W$ . So  $E_i^*W = \mathbf{0}$  for  $r \leq i \leq r+d$ . Now  $E_i^*W = \mathbf{0}$  for  $r+d < i \leq d$  by definition of  $d$ . The result follows.  $\blacksquare$

**Proposition 5.7** ([49]) *With reference to Definition 5.5, any two nonisomorphic irreducible  $T$ -modules are orthogonal.*

PROOF. Let  $W$  and  $U$  denote nonorthogonal irreducible  $T$ -modules. We want to show that  $W$  and  $U$  are isomorphic as  $T$ -modules.

From linear algebra we know that for given nonzero subspace  $U$  we can find  $U^\perp$  such that

$$V = U + U^\perp \quad (\text{orthogonal direct sum}).$$

For any  $w \in W$  let  $\sigma(w)$  denote the orthogonal projection of  $w$  onto  $U$ . So  $\sigma(w)$  is the unique vector in  $V$  such that

$$\sigma(w) \in U \quad \text{and} \quad w - \sigma(w) \in U^\perp.$$

We show that  $\sigma : W \rightarrow U$ ,  $w \rightarrow \sigma(w)$  is a  $T$ -module isomorphism.

**Claim 1.**  $(B\sigma - \sigma B)W = 0$  for every  $B \in T$ .

Proof of Claim 1. For every  $w \in W$

$$B\sigma(w) \in U,$$

because  $U$  is  $T$ -module and

$$Bw = \underbrace{B\sigma(w)}_{\in U} + \underbrace{(Bw - B\sigma(w))}_{\in U^\perp}$$

because  $U^\perp$  is  $T$ -module (see Lemma 5.4(ii)). Since  $\sigma(Bw)$  denote the orthogonal projection of  $Bw$  onto  $U$ , from above we have

$$\sigma(Bw) = B\sigma(w)$$

and Claim 1 is proved.

**Claim 2.**  $\sigma : W \rightarrow U$  is injective.

Proof of Claim 2. Let  $\ker(\sigma) = \{w \in W \mid \sigma(w) = \mathbf{0}\}$  denote the kernel of  $\sigma$  on  $W$ . Note that  $\ker(\sigma)$  is subspace of  $W$  and for any  $B \in T$  we have  $B\ker(\sigma) \subseteq \ker(\sigma)$  (by Claim 1,  $\sigma(Bw) = B\sigma(w)$ , so if  $w \in \ker(\sigma)$  then  $\sigma(Bw) = 0$ , which yields  $Bw \in \ker(\sigma)$ ). So  $\ker(\sigma)$  is a  $T$ -submodule of  $W$ , and by irreducibility of  $W$ ,  $\ker(\sigma) = \{\mathbf{0}\}$  or  $K = W$ . Since  $\langle W, U \rangle \neq 0$ , we have  $\ker(\sigma) \neq W$ . Thus  $\ker(\sigma) = \{\mathbf{0}\}$  and the result follows.

**Claim 3.** The map  $\sigma : W \rightarrow U$  is surjective.

Proof of Claim 3. Let  $\text{im}(\sigma) = \{\sigma(w) \mid w \in W\}$  denote the image of  $\sigma$  on  $U$ . Note that  $\text{im}(\sigma)$  is subspace of  $U$ , and using Claim 1 it is not hard to see that  $\text{im}(\sigma)$  is a  $T$ -submodule of  $U$  ( $\forall w \in W, \forall B \in T, B\sigma(w) = \sigma(Bw) \in \text{im}(\sigma)$ ). By irreducible of  $U$ , we have  $\text{im}(\sigma) = \{\mathbf{0}\}$  or  $\text{im}(\sigma) = U$ . Since  $\langle W, U \rangle \neq 0$ , we have  $\text{im}(\sigma) \neq \{\mathbf{0}\}$  and the result follows.  $\blacksquare$

**Corollary 5.8** ([49, 9]) *With reference to Definition 5.5, let  $\Psi = \Psi(x) = \{G_\phi \mid \phi \in \Phi\}$  denote the set of isomorphism classes of irreducible  $T$ -modules, indexed by some set  $\Phi = \Phi(x)$  (this means that for each irreducible  $T$ -module  $W$ , there is a unique  $\lambda \in \Phi$  such that  $W \in G_\lambda$ ; we refer to  $\lambda$  as the type of  $W$ ). The elements of  $\Phi$  are called types. For  $G_\phi \in \Psi$  define*

$$\begin{aligned} V_\phi &= \text{subspace of } V \text{ spanned by the irreducible } T\text{-modules of type } \phi \\ &= \text{span}\{W \mid W \in G_\phi\} \end{aligned}$$

(call  $V_\phi$  the  $\phi$ -homogeneous component of  $V$ ). The following (i)–(vi) hold.

- (i) *Let  $W$  and  $W'$  denote irreducible  $T$ -modules. Then  $W$  and  $W'$  are  $T$ -isomorphisms if and only if  $W$  and  $W'$  have the same type.*
- (ii)  *$V_\phi$  is a  $T$ -module.*
- (iii)  *$V = \sum_{\phi \in \Phi} V_\phi$  (orthogonal direct sum of  $T$ -modules).*
- (iv) *For a given  $G_\phi \in \Psi$  and an irreducible  $T$ -module  $W \subseteq V_\phi$  the dimension, diameter, endpoint etc. of  $W$  depends only on  $\phi$ . So instead of  $\dim(W)$ ,  $d(W)$ ,  $r(W)$  etc. we can write  $\dim(\phi)$ ,  $d(\phi)$ ,  $r(\phi)$  etc.*
- (v) *For all  $\phi \in \Phi$ ,  $V_\phi$  can be decomposed as an orthogonal direct sum of irreducible  $T$ -modules of type  $\phi$  (this decomposition is not unique).*
- (vi) *Referring to (v), the number of irreducible  $T$ -modules in the decomposition is independent of the decomposition. We shall denote this number by  $\text{mult}(\phi)$  and refer to it as the multiplicity (in  $V$ ) of the irreducible  $T$ -modules of type  $\phi$ . Moreover if*

$$V_\phi = W_1 + W_2 + \dots + W_m \quad (\text{orthogonal direct sum})$$

$$\text{then } m = \frac{\dim(V_\phi)}{\dim(\phi)}.$$

PROOF. Routine. ■

**Definition 5.9** *With reference to Definition 5.5, let  $\Psi = \{G_\phi \mid \phi \in \Phi\}$  and  $V_\phi$  ( $\phi \in \Phi$ ) be as in Corollary 5.8. For each integer  $i$  ( $0 \leq i \leq D$ ) define  $\Phi_i = \Phi_i(x)$  to be the set of  $\phi \in \Phi$  such that the irreducible  $T$ -modules of type  $\phi$  have endpoint  $i$  and define*

$$\begin{aligned} V_i &= \text{subspace of } V \text{ spanned by } T\text{-modules } V_\phi, \text{ where } \phi \in \Phi_i \\ &= \text{subspace of } V \text{ spanned by irreducible } T\text{-modules with endpoint } i. \end{aligned}$$

**Lemma 5.10** ([9, Section 3]) *With reference to Definition 5.9, we have*

$$V = \sum_{i=0}^D V_i \quad (\text{orthogonal direct sum of } T\text{-modules}).$$

Let the map  $\varphi_i : V \rightarrow V_i$  denote an orthogonal projection for  $0 \leq i \leq D$ . Then the following hold

$$\begin{aligned} I &= \varphi_0 + \varphi_1 + \dots + \varphi_D, \\ \varphi_i \varphi_j &= \delta_{ij} \varphi_i \quad (0 \leq i, j \leq D), \\ \varphi_i B &= B \varphi_i \quad (B \in T, 0 \leq i \leq D), \\ E_i^* \varphi_r &= 0 \quad (0 \leq i < r \leq D). \end{aligned}$$



**Remark 5.11** Note that Corollary 5.8 and Lemma 5.10 give us some informations about (possible) structure and behaviour of  $T$ -modules. Just for a moment fix some  $i$  ( $0 \leq i \leq D$ ). Note that maybe we can have something like

$$V_i = U_\eta + U_\mu + \dots + U_\nu \quad (\text{orthogonal direct sum of } T\text{-modules})$$

where every of  $U_\eta, U_\mu, \dots, U_\nu$  is spanned by irreducible  $T$ -modules of different type, and any of them is of endpoint  $i$ . So, for example, maybe it can happen that  $U_\eta$  is a thin module of endpoint  $i$  and diameter  $s_1$ , while  $U_\mu$  is not a thin module of endpoint  $i$  and has diameter  $s_2$  where  $s_1 \neq s_2$ . On the other hand, maybe we have that  $U_\nu$  is unique irreducible  $T$ -module of endpoint  $i$  and diameter  $s_1$  (just one), while  $U_\lambda$  is up to isomorphism a unique irreducible  $T$ -module of endpoint  $i$  and diameter  $s_2$  (so maybe there are more of them, but they are all isomorphic).

**Research problem 5.12** For a given distance-regular graph, compute orthogonal projections  $\varphi_i$  ( $0 \leq i \leq D$ ) from Lemma 5.10.

### 5.3 Irreducible $T$ -module with endpoint 0

In this section we show that  $\Gamma$  has a unique irreducible  $T$ -module with endpoint 0. From Definition 5.9, we denote this  $T$ -module by  $V_0$ . We call  $V_0$  the *primary module*. It appears in  $V$  with multiplicity 1 and it has basis  $\{\omega_i \mid 0 \leq i \leq D\}$ , where

$$\omega_i = \sum_{y \in \Gamma_i(x)} \hat{y}. \quad (5.7)$$

**Lemma 5.13** Let  $\omega$  denote the all ones vector in  $V$ . We have

$$\begin{aligned} \omega_i &= A_i \hat{x} & (0 \leq i \leq D), \\ \omega_i &= E_i^* \omega & (0 \leq i \leq D), \\ E_i^* \omega_j &= \delta_{ij} \omega_i & (0 \leq i, j \leq D), \\ \langle \omega_i, \omega_j \rangle &= \delta_{ij} k_i & (0 \leq i, j \leq D). \end{aligned}$$

PROOF. Routine. ▀

**Proposition 5.14** Let  $W$  denote a  $T$ -module. The following claims (i)–(iv) are equivalent.

- (i)  $W$  is irreducible  $T$ -module with endpoint 0.
- (ii)  $W = \mathcal{M} \hat{x}$  ( $\mathcal{M}$  is Bose-Mesner algebra).
- (iii)  $W$  is thin  $T$ -module with endpoint 0.
- (iv)  $W$  is unique  $T$ -module with endpoint 0.

PROOF. We show chain of implications.

(i)  $\Rightarrow$  (ii) If  $W$  is  $T$ -module with endpoint 0, then  $E_0^* W \neq \{0\}$ , and with that  $E_0^* W = \text{span}\{\hat{x}\}$ . Now let  $W' := \mathcal{M} \hat{x}$ , and note that

$$\begin{aligned} W' &= \mathcal{M} \hat{x} = (\text{span}\{A_0, A_1, \dots, A_D\}) \hat{x} = \\ &= \text{span}\{A_0 \hat{x}, A_1 \hat{x}, \dots, A_D \hat{x}\} = \text{span}\{\omega_0, \omega_1, \dots, \omega_D\}. \end{aligned}$$

By definition,  $\mathcal{M}w' \subseteq W'$ . Thus it is not hard to see

$$\mathcal{M}^*W' = \mathcal{M}^*\text{span}\{\omega_0, \omega_1, \dots, \omega_D\} \subseteq W'$$

by Lemma 5.13. Thus  $W'$  is  $T$ -module. In the end

$$W' = \mathcal{M}\hat{x} = \mathcal{M}E_0^*W \subseteq W \quad \Rightarrow \quad W' \subseteq W.$$

Since  $W$  is irreducible, the result follows.

(ii) $\Rightarrow$ (iii) Note that  $\mathcal{M}W \subseteq W$ , and  $\mathcal{M}\hat{x} = \text{span}\{\omega_0, \omega_1, \dots, \omega_D\}$ . It follows that  $\mathcal{M}^*W \subseteq W$  and hence  $W$  is  $T$ -module with endpoint 0. It remains to show that  $W$  is thin. We have

$$E_i^*W = E_i^*\mathcal{M}^*\text{span}\{\omega_0, \omega_1, \dots, \omega_D\} = \text{span}\{\omega_i\}$$

This yield  $\dim(E_i^*W) = 1$ , and the result follows.

(iii) $\Rightarrow$ (iv) Assume that  $W$  is a thin  $T$ -module of endpoint 0. We have  $TW \subseteq W$  and  $E_0^*W \neq \{\mathbf{0}\}$  i.e.  $E_0^*W = \text{span}\{\hat{x}\}$ . Note that

$$TE_0^*W = T\text{span}\{\hat{x}\} = \mathcal{M}\hat{x}$$

and  $\mathcal{M}\hat{x} = TE_0^*W \subseteq W$ . Since both of  $T$ -modules  $W$  and  $\mathcal{M}\hat{x}$  are thin, we have  $E_i^*\mathcal{M}\hat{x} = E_i^*W$  ( $0 \leq i \leq D$ ), and with that  $W = \mathcal{M}\hat{x}$ .

If we pick any other thin  $T$ -module  $U$  of endpoint 0, in the same way as above, we can prove that  $U = \mathcal{M}\hat{x}$ , and with that  $W$  is unique  $T$ -module of endpoint 0. The result follows.

(iv) $\Rightarrow$ (i) To obtain a contradiction, assume that  $\Gamma$  is reducible. Then we can write  $W$  as orthogonal direct sum of irreducible  $T$ -modules. Since  $\hat{x} \in W$ , these modules cannot all be orthogonal to  $\hat{x}$ . So one of them has endpoint 0 and hence contains  $\hat{x}$ , for example  $\hat{x} \in U$ . By assumption,  $W$  is unique  $T$ -module with endpoint 0, which yield  $W = U$ , a contradiction. The result follows.  $\blacksquare$

## 5.4 Irreducible $T$ -modules with endpoint 1

We cite the main results for irreducible  $T$ -modules with endpoint 1 for bipartite distance-regular graphs.

**Theorem 5.15** ([9, Theorem 7.6]) *Assume that  $\Gamma$  is a bipartite distance-regular graph. Let  $W$  denote an irreducible  $T$ -module of endpoint 1, and pick any nonzero  $v \in E_1^*W$ . Then  $W$  has orthogonal basis  $\{E_i^*A_{i-1}v \mid 1 \leq i \leq D-1\}$ . In particular  $W$  is thin and has diameter  $D-2$ .*

**Corollary 5.16** ([9, Corollary 7.7]) *Assume that  $\Gamma$  is a bipartite distance-regular graph. Up to isomorphism, there is a unique irreducible  $T$ -module of endpoint 1.*

**Lemma 5.17** ([9, Lemma 7.8]) *Assume that  $\Gamma$  is a bipartite distance-regular graph and let  $V_1$  denote subspace of  $V$  spanned by all irreducible  $T$ -modules of endpoint 1. Then*

$$\dim(E_i^*V_1) = k - 1 \quad (1 \leq i \leq D - 1),$$

$$E_0^*V_1 = \{\mathbf{0}\} \quad \text{and} \quad E_D^*V_1 = \{\mathbf{0}\}.$$

## 5.5 Note about the case when $\Gamma$ is thin

Suppose  $\Gamma = (X, \mathcal{R})$  is a distance-regular graph with diameter  $D \geq 3$ . Pick  $x \in X$  and write  $T = T(x)$  and  $E_i^* = E_i^*(x)$ . An irreducible  $T$ -module  $W$  is said to be *thin* if

$$\dim E_i^*W \leq 1 \quad (0 \leq i \leq D).$$

For all  $x \in X$ , we say  $\Gamma$  is *thin* with respect to  $x$  whenever every irreducible  $T(x)$ -module is thin. We say  $\Gamma$  is *thin* if  $\Gamma$  is thin with respect to every vertex  $x \in X$ .

A thin distance-regular graphs are studied by P. TERWILLIGER in [47]. For the reasoning that will be come clear in next two chapters, we recall here some of beautiful claims from the same paper.

**Theorem 5.18** ([47]) *Suppose  $\Gamma = (X, \mathcal{R})$  denote a distance-regular graph with diameter  $D \geq 3$ . Pick  $x \in X$  and write  $T = T(x)$  and  $E_i^* = E_i^*(x)$ . The following (i)–(v) hold.*

- (i) *If  $W$  is irreducible  $T$ -module then  $E_i^*W$  is irreducible  $E_i^*T$ -module (or in another words  $W$  is irreducible  $E_i^*TE_i^*$ -module).*
- (ii) *If  $\Gamma$  is thin with respect to  $x$  then  $E_i^*TE_i^*$  is commutative for all integers  $i$  ( $0 \leq i \leq D$ ).*
- (iii) *If  $E_i^*TE_i^*$  is commutative for all integers  $i$  ( $0 \leq i \leq D$ ) then  $\Gamma$  is thin with respect to  $x$ .*
- (iv) *If  $E_i^*TE_i^*$  is symmetric for all integers  $i$  ( $0 \leq i \leq D$ ) then  $E_i^*TE_i^*$  is commutative for all integers  $i$  ( $0 \leq i \leq D$ ).*
- (v) *If for all  $y, z \in X$  with  $\partial(x, y) = \partial(x, z)$  there exists  $g \in \text{Aut}(\Gamma)$  such that  $gx = x$ ,  $gy = z$  and  $gz = y$  then  $E_i^*TE_i^*$  is symmetric for all integers  $i$  ( $0 \leq i \leq D$ ).*

PROOF. (i) By definition of  $E_i^*W$  and  $E_i^*T$  we have that  $E_i^*W$  is  $E_i^*T$ -module. It remains to show that  $E_i^*W$  is irreducible. To obtain a contradiction, assume that  $E_i^*W$  is not irreducible. Then there exist subspace  $U$

$$\mathbf{0} \subset U \subset E_i^*W, \quad U \neq \mathbf{0}, \quad U \neq E_i^*W$$

such that  $U$  is  $E_i^*T$ -module. Since  $W$  is irreducible, we have

$$TU = W.$$

Now we have

$$E_i^*W = E_i^*TU \subseteq U$$

and thus  $E_i^*W \subseteq U$ , a contradiction (by assumption  $U \neq E_i^*W$ ). The result follows.

(ii) Let us write the standard module  $V$  as an orthogonal direct sum of irreducible  $T$ -modules

$$V = \sum_{s \in \Phi} W_s$$

indexed with some set  $\Phi = \Phi(x)$ . Then for any  $i$  ( $0 \leq i \leq D$ ),  $E_i^*V = \sum_{s \in \Phi} E_i^*W_s$ . For irreducible  $T$ -module  $W$  and for any  $P \in E_i^*T$  we have

$$PW \subseteq W \quad (\text{because } W \text{ is irreducible } T\text{-module}),$$

$$PW \subseteq E_i^*W \quad (\text{because } P = E_i^*B \text{ for some } B \in T).$$

Thus  $E_i^*W$  is  $E_i^*T$  module (or  $W$  is  $E_i^*TE_i^*$ -module).

Since  $\Gamma$  is thin, we have that  $\dim(E_i^*W_s) \leq 1$  ( $\forall s \in \Phi$ ) and with that if  $E_i^*W_s$  is nonzero there exists a basis  $\{u_s\}$  of subspace  $E_i^*W_s$ . Now pick  $P, Q \in E_i^*TE_i^*$  and let us prove that  $PQ = QP$ . Note that  $\forall v \in V$ ,  $E_i^*v = \sum_{s \in \Phi} \alpha_i u_s$  (for some  $\alpha_i$ 's), and since  $Pu_s = \lambda u_s$  and  $Qu_s = \mu u_s$  (for some  $\lambda$  and  $\mu$ ) we have  $(PQ - QP)u_s = \mathbf{0}$ . This yield  $(PQ - QP)v = \mathbf{0}$  and the result follows.

(iii) Let  $W$  denote some irreducible  $T$ -module, pick some  $i$  ( $0 \leq i \leq D$ ) and abbreviate  $S := E_i^*TE_i^*$ . We want to show that  $E_i^*W$  is an irreducible  $S$ -module (see Claim 1) and that each irreducible  $S$ -module  $U$  has dimension 1 (see Claim 2).

CLAIM 1. Lets prove that  $E_i^*W$  is an irreducible  $E_i^*TE_i^*$ -module. Suppose  $\mathbf{0} \subsetneq U \subsetneq E_i^*W$ , where  $U$  is a  $E_i^*TE_i^*$ -module. By irreducibility,  $TU = W$ , so  $U \supseteq E_i^*TE_i^*U = E_i^*TU = E_i^*W$ , that is,  $U \supseteq E_i^*W$ . This is a contradiction.

CLAIM 2. Lets prove that each irreducible  $S = E_i^*TE_i^*$ -module  $U$  has dimension 1. Pick  $\mathbf{0} \neq B \in E_i^*TE_i^*$  and note that  $BU \subseteq U$ . Since  $\mathbb{C}$  is algebraically closed,  $B$  has an eigenvector  $w \in U$  with eigenvalue  $\theta$ . By irreducibility, we have  $SU = U$ . Then  $(B - \theta I)U = (B - \theta I)S w = S(B - \theta I)w = 0$ . Hence  $B|_U = \theta I|_U$  for all  $B \in S$ . Thus each 1 dimensional subspace of  $U$  is an  $S$ -module. We have  $\dim(U) = 1$ .

By Claim 1 and Claim 2, we have that  $\Gamma$  is thin with respect to  $x$ .

(iv) Fix  $i$  and pick  $B, C \in E_i^*TE_i^*$ . Since  $B, C$  and  $BC$  are symmetric

$$BC = (BC)^\top = C^\top B^\top = CB.$$

Hence  $E_i^*TE_i^*$  is commutative.

(v) See [47, Theorem 5.1(ii)]. ■

## 5.6 The raising and lowering matrices

In this section we define raising and lowering matrices.

**Definition 5.19** Define matrices  $L = L(x)$  and  $R = R(x)$  in  $T$  as follows:

$$L = \sum_{h=0}^D E_{h-1}^* A E_h^*, \quad R = \sum_{h=0}^D E_{h+1}^* A E_h^*. \quad (5.8)$$

Note that the  $(y, z)$ -entry of  $L$  is 1 if  $y, z$  are adjacent with  $\partial(x, z) = \partial(x, y) + 1$  and 0 otherwise ( $y, z \in X$ ). The  $(y, z)$ -entry of  $R$  is 1 if  $y, z$  are adjacent with  $\partial(x, y) = \partial(x, z) + 1$  and 0 otherwise ( $y, z \in X$ ). It is well-known that if  $\Gamma$  is bipartite, then  $R + L = A$ . We refer to  $R$  and  $L$  as the *raising* and *lowering* matrix with respect to  $x$ , respectively.

We now recall some products in  $T$ .

**Lemma 5.20** ([36, Lemma 6.1]) *For arbitrary  $u, v \in X$  and  $0 \leq i, j \leq D$  the following holds:*

$$(E_i^* A_j E_h^*)_{uv} = \begin{cases} 1 & \text{if } \partial(x, u) = i, \partial(u, v) = j, \partial(x, v) = h, \\ 0 & \text{otherwise.} \end{cases}$$

**Lemma 5.21** ([36, Lemma 6.5]) *For arbitrary  $u, v \in X$  and  $0 \leq h, i, j, r, s \leq D$  the following holds:*

$$(E_h^* A_r E_i^* A_s E_j^*)_{uv} = \begin{cases} |\Gamma_i(x) \cap \Gamma_r(u) \cap \Gamma_s(v)| & \text{if } \partial(x, u) = h, \partial(x, v) = j, \\ 0 & \text{otherwise.} \end{cases}$$

## The scalars $\Delta_i$

---

Let  $\Gamma$  denote a distance-regular with diameter  $D \geq 4$  and valency  $k \geq 3$ . In this chapter we introduce certain scalars  $\Delta_i$  and  $\gamma_i$  ( $2 \leq i \leq D - 1$ ) which we will use in Chapters 7, 8 and 9.

**Definition 6.1** Let  $\Gamma$  denote a distance-regular with diameter  $D \geq 4$  and valency  $k \geq 3$ . Then for  $2 \leq i \leq D - 1$  we define

$$\Delta_i = (b_{i-1} - 1)(c_{i+1} - 1) - (c_2 - 1)p_{2i}^i$$

and

$$\gamma_i = \frac{c_i(b_{i-1} - 1)}{p_{2i}^i} \tag{6.1}$$

(observe that  $p_{2i}^i > 0$  by [8, Lemma 11]).

**Lemma 6.2** [8, Theorem 12] *With reference to Definition 6.1 we have  $\Delta_i \geq 0$  for  $2 \leq i \leq D - 1$ .*

**Lemma 6.3** [8, Theorem 13] *With reference to Definition 6.1, the following (i), (ii) are equivalent for  $2 \leq i \leq D - 1$ .*

- (i)  $\Delta_i = 0$ .
- (ii) *For all  $u, v, z \in X$  with  $\partial(u, v) = 2$ ,  $\partial(u, z) = \partial(v, z) = i$ ,*

$$|\Gamma(u) \cap \Gamma(v) \cap \Gamma_{i-1}(z)| = \gamma_i. \tag{6.2}$$

**Theorem 6.4** *With reference to Definition 6.1, if  $\Delta_2 = 0$  then  $D \leq 5$  or  $c_2 \in \{1, 2\}$ .*

**PROOF.** Recall that  $\Delta_2 = (k - 2)(c_3 - 1) - (c_2 - 1)p_{22}^2$ . Note that if  $\Delta_2 = 0$ , then using Corollary 3.7(v) and (6.2) we have

$$c_3 = \frac{c_2(c_2 - 1)(k - 2)}{k - 3c_2 + c_2^2} + 1, \tag{6.3}$$

$$\gamma_2 = \frac{(c_2 - 1)(c_2 - 2)}{k - 2} + 1, \tag{6.4}$$

and

$$\frac{1}{\gamma_2} = \frac{k - 2}{k - 3c_2 + c_2^2}. \tag{6.5}$$

Observe that the above denominators are nonzero as  $k - 3c_2 + c_2^2 = (c_2 - 1)(c_2 - 2) + k - 2$ . Suppose now that  $c_2 \geq 3$ . We will show that  $D \leq 5$  in this case. Note that it follows from (6.4) that  $\gamma_2 \geq 2$ , and so

$$k - 2 = \frac{(c_2 - 1)(c_2 - 2)}{\gamma_2 - 1}. \tag{6.6}$$

Using (6.3) and (6.5) we easily find

$$c_3 - 1 = \frac{c_2(c_2 - 1)}{\gamma_2}. \quad (6.7)$$

Suppose  $D \geq 6$ . By [3, Proposition 4.1.6], we have  $c_3 \leq b_3$ , and so  $k \geq 2c_3$ . Using this and (6.6), (6.7) we find  $0 \geq (\gamma_2 - 2)(c_2 + 2) + 4$ , a contradiction. ■

By Theorem 6.4, it is natural to study the cases  $c_2 = 1$ ,  $c_2 = 2$  and  $D \leq 5$  separately. In the Chapter 7 we will consider the case  $c_2 = 1$ . We will study the case  $c_2 = 2$  in the Chapter 8 and the case  $D \leq 5$  in the Chapter 9. If  $\Delta_i = 0$  for  $2 \leq i \leq D - 2$ , then  $\Gamma$  is almost 2-homogeneous in the sense of Curtin, and these graphs are well-understood [12]. Therefore, we will also assume  $\Delta_i \neq 0$  for at least one index  $i$  ( $3 \leq i \leq D - 2$ ). Note that this implies  $D \geq 5$ .

**Definition 6.5** With reference to Definition 6.1, assume that  $\Delta_2 = 0$  and that  $\Delta_i = (b_{i-1} - 1)(c_{i+1} - 1) \neq 0$  for at least one  $i$  ( $3 \leq i \leq D - 2$ ). Let

$$f = \min\{i \in \mathbb{N} \mid 3 \leq i \leq D - 2 \text{ and } \Delta_i \neq 0\},$$

$$\ell = \max\{i \in \mathbb{N} \mid 3 \leq i \leq D - 1 \text{ and } \Delta_i \neq 0\}.$$

**Lemma 6.6** *With reference to Definition 6.5, assume that  $c_2 = 1$ . Then the following (i)-(iv) hold.*

- (i)  $c_i = 1$  for  $2 \leq i \leq f$ .
- (ii) If  $\ell \leq D - 2$  then  $b_i = 1$  for  $\ell \leq i \leq D - 1$ .
- (iii)  $f < \ell$ .
- (iv)  $\Delta_i \neq 0$  for  $f \leq i \leq \ell$ .

**PROOF.** Recall that by [3, Proposition 4.1.6(i)] we have  $k = b_0 > b_1 \geq b_2 \geq \dots \geq b_{D-1} \geq 1$  and  $1 = c_1 \leq c_2 \leq \dots \leq c_D = k$ . Note also that  $\Delta_f = (b_{f-1} - 1)(c_{f+1} - 1)$ ,  $\Delta_\ell = (b_{\ell-1} - 1)(c_{\ell+1} - 1)$ .

(i) Pick arbitrary  $i$  ( $2 \leq i \leq f - 1$ ). Since  $0 = \Delta_i = (b_{i-1} - 1)(c_{i+1} - 1)$ , we have  $b_{i-1} = 1$  or  $c_{i+1} = 1$ . If  $b_{i-1} = 1$  then  $b_i = b_{i+1} = \dots = b_{f-1} = 1$  which imply  $\Delta_f = 0$ , a contradiction. So  $c_{i+1} = 1$  and the result follows.

(ii) Similar to (i) above.

(iii) If  $\ell = D - 1$  then we have  $f < \ell$  by the assumptions from Definition 6.5. Assume that  $f = \ell < D - 1$ . Then  $c_f = b_\ell = 1$  by (i), (ii) above. This implies  $k = 2$ , a contradiction.

(iv) Since  $\Delta_f \neq 0$ , we have  $c_{f+1} \geq 2$ . This implies  $c_i \geq 2$  for  $i \geq f + 1$ . On the other hand, since  $\Delta_\ell \neq 0$ , we have  $b_{\ell-1} \geq 2$ . This implies  $b_i \geq 2$  for  $i \leq \ell - 1$ . The result follows. ■

**Lemma 6.7** *With reference to Definition 6.1, if  $c_2 \geq 2$  then the following (i)-(iii) hold.*

- (i)  $c_i \geq c_{i-1} + 1$  for  $1 \leq i \leq D$ .
- (ii)  $D \leq k$ . In particular,  $k \geq 4$ .
- (iii)  $i \leq c_i \leq k - D + i$  ( $1 \leq i \leq D$ ) and  $D - i \leq b_i \leq k - i$  ( $0 \leq i \leq D - 1$ ).

**PROOF.** Claims (i) and (ii) follow immediately from [3, Theorem 5.2.1, Corollary 5.2.2]. Claim (iii) follows immediately from (i) and  $b_i = k - c_i$ . ■

**Lemma 6.8** *With reference to Definition 6.1, pick arbitrary  $i$  ( $2 \leq i \leq D-1$ ). Then the following (i), (ii) hold.*

$$(i) \text{ If } c_2 \geq 2 \text{ and } \Delta_i = 0, \text{ then } \gamma_i = \frac{c_i(c_2 - 1)}{c_{i+1} - 1} = \frac{b_i(1 - c_2)}{b_{i-1} - 1} + c_2.$$

(ii) *Assume that  $c_2 = 2$ . Then  $\Delta_i = 0$  if and only if  $c_i - c_{i-1} - 1 = 0$  and  $c_{i+1} - c_i - 1 = 0$ .*

PROOF. (i) Recall that  $\Delta_i = (b_{i-1} - 1)(c_{i+1} - 1) - (c_2 - 1)p_{2i}^i$ . Note that if  $\Delta_i = 0$ , then using Lemma 3.7(ii) we have

$$c_{i+1} = \frac{c_i(c_2 - 1)(b_{i-1} - 1)}{b_i + (c_i - c_{i-1} - 1)c_2} + 1$$

(observe that the above denominator is nonzero since  $c_2 \geq 2$  implies  $c_i - c_{i-1} - 1 \geq 0$  by Lemma 6.7). Note that  $c_{i+1} \neq 1$  and  $b_{i-1} \neq 1$  by Lemma 6.7. Using (6.1) and the fact that  $(c_2 - 1)p_{2i}^i = (b_{i-1} - 1)(c_{i+1} - 1)$  we have

$$\gamma_i = \frac{c_i(c_2 - 1)}{c_{i+1} - 1} = \frac{c_i(c_2 - 1)}{\frac{c_i(c_2 - 1)(b_{i-1} - 1)}{b_i + (c_i - c_{i-1} - 1)c_2}} = \frac{b_i(1 - c_2)}{b_{i-1} - 1} + c_2.$$

(ii) Note that  $2\Delta_i = (b_{i-1} - 1)(c_{i+1} - c_i - 1) + (c_{i+1} - 1)(c_i - c_{i-1} - 1)$ . The result follows since  $c_{i+1} \neq 1$  and  $b_{i-1} \neq 1$  by Lemma 6.7.  $\blacksquare$

**Corollary 6.9** *With reference to Definition 6.1, assume that  $c_2 = 2$ . Then the following (i), (ii) hold.*

(i) *If  $\Delta_i = 0$  then  $\gamma_i = 1$  ( $2 \leq i \leq D-1$ ).*

(ii) *If  $\Delta_2 = 0$  then  $c_3 = 3$  and  $p_{22}^2 = 2(k-2)$ .*

PROOF. Immediate from Lemma 6.8.  $\blacksquare$

**Lemma 6.10** *With reference to Definition 6.5, assume that  $c_2 = 2$ . Then the following (i)–(iii) hold.*

(i)  *$(k-2)(b_{i-1} - 1) - c_{i-1}b_i > 0$  for  $2 \leq i \leq D-2$ .*

(ii) *If  $\ell = D-1$  then  $(k-2)(b_{D-2} - 1) - c_{D-2}b_{D-1} > 0$ .*

(iii)  *$(k-2)(c_{i+1} - 1) - c_i b_{i+1} > 0$  for  $2 \leq i \leq D-2$ .*

PROOF. (i), (ii) From Lemma 6.7 we have  $k-2 > c_{i-1}$  for  $i = 2, 3, \dots, D-2$  and  $b_{i-1} - 1 \geq b_i$  for  $i = 2, 3, \dots, D$ . This shows (i). Note that  $(k-2)(b_{D-2} - 1) - c_{D-2}b_{D-1} = 0$  if and only if  $c_{D-2} = k-2$  ( $c_{D-2} = k-2$  yields  $b_{D-2} = 2$  and  $b_{D-1} = 1$ ). Since  $\ell = D-1$  yields  $c_{D-2} \neq k-2$ , the result follows.

(iii) Note that  $k-2 > b_{i+1}$  and  $c_{i+1} - 1 \geq c_i$  for  $2 \leq i \leq D-2$ .  $\blacksquare$

# On the Terwilliger algebra of a bipartite DRG with $c_2 = 1$

Let  $\Gamma$  denote a bipartite distance-regular graph with diameter  $D \geq 4$  and valency  $k \geq 3$ . Let  $X$  denote the vertex set of  $\Gamma$ , and let  $A$  denote the adjacency matrix of  $\Gamma$ . For  $x \in X$  and for  $0 \leq i \leq D$ , let  $\Gamma_i(x)$  denote the set of vertices in  $X$  that are distance  $i$  from vertex  $x$ . Define a parameter  $\Delta_2$  in terms of the intersection numbers by  $\Delta_2 = (k - 2)(c_3 - 1) - (c_2 - 1)p_{22}^2$ . In Theorem 6.4 we showed that  $\Delta_2 = 0$  implies that  $D \leq 5$  or  $c_2 \in \{1, 2\}$ .

For  $x \in X$  let  $T = T(x)$  denote the subalgebra of  $\text{Mat}_X(\mathbb{C})$  generated by  $A, E_0^*, E_1^*, \dots, E_D^*$ , where for  $0 \leq i \leq D$ ,  $E_i^*$  represents the projection onto the  $i$ th subconstituent of  $\Gamma$  with respect to  $x$ . In this chapter we assume  $\Gamma$  has the property that for  $2 \leq i \leq D - 1$ , there exist complex scalars  $\alpha_i, \beta_i$  such that for all  $x, y, z \in X$  with  $\partial(x, y) = 2$ ,  $\partial(x, z) = i$ ,  $\partial(y, z) = i$ , we have  $\alpha_i + \beta_i |\Gamma_1(x) \cap \Gamma_1(y) \cap \Gamma_{i-1}(z)| = |\Gamma_{i-1}(x) \cap \Gamma_{i-1}(y) \cap \Gamma_1(z)|$ . We additionally assume that  $\Delta_2 = 0$  with  $c_2 = 1$ .

Under the above assumptions we study the algebra  $T$ . We show that if  $\Gamma$  is not almost 2-homogeneous, then up to isomorphism there exists exactly one irreducible  $T$ -module with endpoint 2. We give an orthogonal basis for this  $T$ -module, and we give the action of  $A$  on this basis. This chapter presents joint work with M. S. MacLean and Š. Miklavič, and the results are published in the journal “Linear algebra and its applications 496” (see [28]).

For the rest of this chapter we refer to the following definition.

**Definition 7.1** Let  $\Gamma = (X, \mathcal{R})$  denote a bipartite distance-regular graph with diameter  $D \geq 4$ , valency  $k \geq 3$ , intersection numbers  $b_i, c_i$ , and distance matrices  $A_i$  ( $0 \leq i \leq D$ ). We fix  $x \in X$  and let  $E_i^* = E_i^*(x)$  ( $0 \leq i \leq D$ ) and  $T = T(x)$  denote the dual idempotents and the Terwilliger algebra of  $\Gamma$  with respect to  $x$ , respectively. Let  $R = R(x)$  and  $L = L(x)$  be the raising and lowering matrices from Subsection 5.6. For  $2 \leq i \leq D - 1$  we define  $\Delta_i = (b_{i-1} - 1)(c_{i+1} - 1) - (c_2 - 1)p_{2i}^i$ , and numbers  $f = \min\{i \in \mathbb{N} \mid 3 \leq i \leq D - 2 \text{ and } \Delta_i \neq 0\}$ , and  $\ell = \max\{i \in \mathbb{N} \mid 3 \leq i \leq D - 1 \text{ and } \Delta_i \neq 0\}$  as in Section 6.

## 7.1 Maps $G_i, H_i$ and $I_i$

With reference to Definition 7.1, in this section we introduce certain maps  $G_i, H_i, I_i$  ( $2 \leq i \leq D - 1$ ). We will later assume that these maps are linearly dependent.

**Definition 7.2** With reference to Definition 7.1, for  $y \in \Gamma_2(x)$  and for all integers  $i, j$  we define  $\mathcal{D}_j^i = \mathcal{D}_j^i(x, y)$  by

$$\mathcal{D}_j^i := \Gamma_{ij}(x, y) = \Gamma_i(x) \cap \Gamma_j(y).$$

We observe  $\mathcal{D}_j^i = \emptyset$  unless  $0 \leq i, j \leq D$  and either  $i = j$  or  $|i - j| = 2$ . Moreover,  $|\mathcal{D}_j^i| = p_{ij}^2$ . We define maps  $G_i, H_i, I_i : \mathcal{D}_i^i \rightarrow \mathbb{N} \cup \{0\}$  ( $2 \leq i \leq D - 1$ ) as follows. For  $z \in \mathcal{D}_i^i$  we let

$$G_i(z) = |\Gamma_{i-1}(z) \cap \mathcal{D}_1^1|, \quad H_i(z) = |\Gamma(z) \cap \mathcal{D}_{i-1}^{i-1}|, \quad I_i(z) = 1.$$



With reference to Definition 7.2, our goal in this chapter is to describe the irreducible  $T$ -modules of endpoint 2 in the case when for every  $y \in \Gamma_2(x)$  and for every  $i$  ( $2 \leq i \leq D-1$ ) there exist complex scalars  $\alpha_i, \beta_i$  such that  $H_i = \alpha_i I_i + \beta_i G_i$ .

Assume the above dependency holds for every  $i$  ( $2 \leq i \leq D-1$ ). If  $\Delta_2 > 0$ , then the irreducible  $T$ -modules with endpoint 2 were studied by MacLean and Miklavič (see [27, Theorem 9.6]). If  $\Delta_i = 0$  for  $2 \leq i \leq D-2$ , then  $\Gamma$  is almost 2-homogeneous, and its irreducible  $T$ -modules with endpoint 2 are described in [12, Theorem 3.11]. In this chapter we therefore assume that  $\Delta_2 = 0$ , and that there exists some  $i$  ( $3 \leq i \leq D-2$ ), such that  $\Delta_i \neq 0$ . We first show that the above scalars  $\alpha_i, \beta_i$  are uniquely determined if  $\Delta_i \neq 0$ . To do this we introduce a vector analogue of maps  $I_i, G_i$  and  $H_i$ .

**Definition 7.3** With reference to Definition 7.2, pick  $y \in \Gamma_2(x)$ . For all integers  $i, j$  define a vector  $\omega_{ij} = \omega_{ij}(x, y)$  by

$$\omega_{ij} = \sum_{z \in \mathcal{D}_j^i} \hat{z}.$$

Observe that  $\omega_{ij} = 0$  if and only if  $\mathcal{D}_j^i = \emptyset$ , and that  $\|\omega_{ij}\|^2 = p_{ij}^2$ .

For  $2 \leq i \leq D-1$  define vectors  $\omega_{ii}^+ = \omega_{ii}^+(x, y)$  and  $\omega_{ii}^- = \omega_{ii}^-(x, y)$  by

$$\omega_{ii}^+ = \sum_{z \in \mathcal{D}_i^i} |\Gamma_{i-1}(z) \cap \mathcal{D}_1^1| \hat{z}, \quad \omega_{ii}^- = \sum_{z \in \mathcal{D}_i^i} |\Gamma(z) \cap \mathcal{D}_{i-1}^{i-1}| \hat{z}.$$

We observe  $\omega_{22}^+ = \omega_{22}^-$ .

Note that the equality  $H_i = \alpha_i I_i + \beta_i G_i$  can be reformulated as  $\omega_{ii}^- = \alpha_i \omega_{ii} + \beta_i \omega_{ii}^+$ .

**Lemma 7.4** [34, Lemma 7.1] [27, Lemma 10.5] *With reference to Definition 7.3 the following (i)-(iv) hold for  $2 \leq i \leq D-1$ .*

- (i)  $\langle \omega_{ii}^+, \omega_{ii} \rangle = k_i c_i (b_{i-1} - 1) / k_2$ .
- (ii)  $\|\omega_{ii}^+\|^2 = k_i c_i (c_2 (b_{i-1} - 1) - (c_2 - 1) b_i) / k_2$ .
- (iii)  $\langle \omega_{ii}^-, \omega_{ii} \rangle = c_i k_i (c_i b_{i-1} + c_{i-1} b_i - k) / (k(k-1))$ .
- (iv)  $\langle \omega_{ii}^-, \omega_{ii}^+ \rangle = k_i c_i (b_i (b_i - b_{i-1}) + c_i (b_{i-1} - 1)) / k_2$ .

**Theorem 7.5** *With reference to Definitions 6.1 and 7.3, pick  $i$  ( $3 \leq i \leq D-1$ ) such that  $\Delta_i \neq 0$ . Assume that there exist complex scalars  $\alpha_i, \beta_i$  such that*

$$\omega_{ii}^- = \alpha_i \omega_{ii} + \beta_i \omega_{ii}^+. \tag{7.1}$$

Then

$$\alpha_i = \frac{c_i (c_i - 1) (b_{i-1} - c_2) - c_i c_{i-1} (b_i - 1) (c_2 - 1)}{c_2 \Delta_i}$$

and

$$\beta_i = \frac{c_i (c_{i+1} - c_i) (b_{i-1} - 1) - b_i (c_{i+1} - 1) (c_i - c_{i-1})}{c_2 \Delta_i}.$$

**PROOF.** Take the inner product of (7.1) with  $\omega_{ii}$  and  $\omega_{ii}^+$ , and then solve the obtained system of linear equations for  $\alpha_i, \beta_i$  using  $\langle \omega_{ii}, \omega_{ii} \rangle = \|\omega_{ii}\|^2 = p_{ii}^2 = k_i p_{2i}^2 / k_2$  and Lemmas 3.7(v) and 7.4. ■

If  $\Delta_2 = 0$  and  $c_2 = 1$ , then we can simplify the above formulae for  $\alpha_i$  and  $\beta_i$ .

**Corollary 7.6** *With reference to Definitions 6.5 and 7.3, pick  $i$  ( $f \leq i \leq \ell$ ). Assume that there exist complex scalars  $\alpha_i, \beta_i$  such that  $\omega_{ii}^- = \alpha_i \omega_{ii} + \beta_i \omega_{ii}^+$ . Then*

$$\alpha_i = \frac{c_i(c_i - 1)}{c_{i+1} - 1}, \quad \beta_i = \frac{c_i(c_{i+1} - c_i)}{c_{i+1} - 1} - \frac{b_i(c_i - c_{i-1})}{b_{i-1} - 1}.$$

PROOF. Note that  $c_{i+1} \geq 2$  and  $b_{i-1} \geq 2$  since  $\Delta_i \neq 0$ . The result now follows from Theorem 7.5.  $\blacksquare$

## 7.2 The sets $\mathcal{D}_i^i(0)$ , $\mathcal{D}_i^i(1)$ and the partition

With reference to Definitions 6.5 and 7.2, pick  $y \in \Gamma_2(x)$  and let  $w$  denote the unique common neighbour of  $x, y$ . In this section we introduce a certain partition of the vertex set  $X$  of  $\Gamma$ . Observe that by the triangle inequality and since  $\Gamma$  is bipartite, for every  $2 \leq i \leq D$  and every  $z \in \mathcal{D}_i^i$  we have  $\partial(z, w) \in \{i - 1, i + 1\}$ .

**Definition 7.7** *With reference to Definition 6.5 and Definition 7.2, pick  $y \in \Gamma_2(x)$  and let  $w$  denote the unique neighbour of  $x, y$ . Then for  $1 \leq i \leq D$  we define  $\mathcal{D}_i^i(0) = \mathcal{D}_i^i(0)(x, y)$ ,  $\mathcal{D}_i^i(1) = \mathcal{D}_i^i(1)(x, y)$  by*

$$\mathcal{D}_i^i(0) = \{z \in \mathcal{D}_i^i \mid \partial(w, z) = i + 1\}, \quad \mathcal{D}_i^i(1) = \{z \in \mathcal{D}_i^i \mid \partial(w, z) = i - 1\}.$$

We observe  $\mathcal{D}_i^i$  is a disjoint union of  $\mathcal{D}_i^i(0)$  and  $\mathcal{D}_i^i(1)$ , and note  $\mathcal{D}_1^1(0) = \mathcal{D}_D^D(0) = \emptyset$ . Note also that there are no edges between  $\mathcal{D}_{i-1}^{i-1}(1)$  and  $\mathcal{D}_i^i(0)$ .

In what follows we refer to the following definition.

**Definition 7.8** *Let  $\Gamma = (X, \mathcal{R})$  denote a bipartite distance-regular graph with diameter  $D \geq 4$ , valency  $k \geq 3$ , intersection numbers  $b_i, c_i$ , and distance matrices  $A_i$  ( $0 \leq i \leq D$ ). We fix  $x \in X$  and let  $E_i^* = E_i^*(x)$  ( $0 \leq i \leq D$ ) and  $T = T(x)$  denote the dual idempotents and the Terwilliger algebra of  $\Gamma$  with respect to  $x$ , respectively. Let  $R = R(x)$  and  $L = L(x)$  be as defined in (5.8). Assume that  $\Delta_2 = 0$ ,  $c_2 = 1$  and that  $\Delta_i = (b_{i-1} - 1)(c_{i+1} - 1) \neq 0$  for at least one  $i$  ( $3 \leq i \leq D - 2$ ). Let*

$$f = \min\{i \in \mathbb{N} \mid 3 \leq i \leq D - 2 \text{ and } \Delta_i \neq 0\},$$

$$\ell = \max\{i \in \mathbb{N} \mid 3 \leq i \leq D - 1 \text{ and } \Delta_i \neq 0\}.$$

For any  $y \in \Gamma_2(x)$ , define  $\mathcal{D}_j^j$ ,  $\mathcal{D}_i^i(0)$  and  $\mathcal{D}_i^i(1)$  ( $0 \leq i, j \leq D$ ) as in Definitions 7.2 and 7.7. Assume that for  $f \leq i \leq \ell$  there exist complex scalars  $\alpha_i, \beta_i$ , such that for all  $y \in \Gamma_2(x)$ ,  $H_i = \alpha_i I_i + \beta_i G_i$ , where  $G_i, H_i, I_i$  are as in Definition 7.2.

**Remark 7.9** *With reference to Definition 7.8, we note that for each integer  $i$  for which  $\Delta_i = 0$ , we have that  $G_i$  is a constant function by Lemma 6.3. Under our assumptions,  $\Delta_i = 0$  for  $2 \leq i \leq f - 1$  and for  $\ell + 1 \leq i \leq D - 1$ . Later in this chapter, in Theorem 7.14, we show that  $H_i$  is also a constant function for these same  $i$  values. Hence it follows that for every  $i$  ( $2 \leq i \leq D - 1$ ), there exist complex scalars  $\alpha_i, \beta_i$  such that  $H_i = \alpha_i I_i + \beta_i G_i$ .*

**Lemma 7.10** [35, Corollary 3.9] *With reference to Definition 7.8, let  $y \in \Gamma_2(x)$ . Then the following (i), (ii) hold.*

$$(i) \quad |\mathcal{D}_i^i(0)| = \frac{(c_{i+1} - 1)b_2 b_3 \dots b_i}{c_1 c_2 \dots c_i} \quad (2 \leq i \leq D - 1).$$

$$(ii) |\mathcal{D}_i^i(1)| = \frac{(b_{i-1} - 1)b_2b_3\dots b_{i-1}}{c_1c_2\dots c_{i-1}} \quad (2 \leq i \leq D).$$

**Corollary 7.11** *With reference to Definition 7.8, let  $y \in \Gamma_2(x)$ . Then the following (i), (ii) hold.*

- (i)  $\mathcal{D}_i^i(0) = \emptyset$  for  $2 \leq i \leq f - 1$ .
- (ii) If  $\ell \leq D - 2$  then  $\mathcal{D}_i^i(1) = \emptyset$  for  $\ell + 1 \leq i \leq D$ .

PROOF. Immediate from Lemma 6.6 and Lemma 7.10. ■

**Lemma 7.12** *With reference to Definition 7.8, let  $y \in \Gamma_2(x)$ . Then the following (i)-(ii) hold for  $f \leq i \leq \ell$ .*

- (i)  $|\Gamma(z) \cap \mathcal{D}_{i-1}^{i-1}(0)| = \frac{c_i(c_i - 1)}{c_{i+1} - 1}$  for every  $z \in \mathcal{D}_i^i(0)$ .
- (ii)  $|\Gamma(z) \cap \mathcal{D}_{i+1}^{i+1}(1)| = \frac{b_i(b_i - 1)}{b_{i-1} - 1}$  for every  $z \in \mathcal{D}_i^i(1)$ .

PROOF. (i) Pick arbitrary  $z \in \mathcal{D}_i^i(0)$ . Then from the definition of  $\mathcal{D}_i^i(0)$  we have that  $G_i(z) = 0$ . By assumption  $H_i(z) = \alpha_i I_i(z) + \beta_i G_i(z)$ , so we have  $|\Gamma(z) \cap \mathcal{D}_{i-1}^{i-1}| = H_i(z) = \alpha_i$ . Observe that  $z$  has no neighbours in  $\mathcal{D}_{i-1}^{i-1}(1)$ . Since  $\mathcal{D}_{i-1}^{i-1}$  is a disjoint union of  $\mathcal{D}_{i-1}^{i-1}(0)$  and  $\mathcal{D}_{i-1}^{i-1}(1)$ , the result now follows from Corollary 7.6.

(ii) Pick  $z \in \mathcal{D}_i^i(1)$ . Note that  $\Gamma_{i-1}(z) \cap \mathcal{D}_1^1 = \{w\}$ ; that is,  $G_i(z) = 1$ . It follows that  $|\Gamma(z) \cap \mathcal{D}_{i-1}^{i-1}| = H_i(z) = \alpha_i + \beta_i$ . Next, note that  $z$  has  $c_i$  neighbours in  $\mathcal{D}_{i+1}^{i+1} \cup \mathcal{D}_{i-1}^{i-1} \subseteq \Gamma_{i-1}(x)$ , which implies

$$|\Gamma(z) \cap \mathcal{D}_{i+1}^{i+1}| = c_i - \alpha_i - \beta_i.$$

Since  $z$  has neighbours only in  $\mathcal{D}_{i+1}^{i+1} \cup \mathcal{D}_{i-1}^{i-1} \cup \mathcal{D}_{i+1}^{i+1}(1) \cup \mathcal{D}_{i-1}^{i-1}$  and the number of neighbours in  $\mathcal{D}_{i-1}^{i-1}$  is the same as in  $\mathcal{D}_{i+1}^{i+1}$ , we have

$$|\Gamma(z) \cap \mathcal{D}_{i+1}^{i+1}(1)| = k + \alpha_i + \beta_i - 2c_i.$$

The result now follows from Corollary 7.6 and (3.4). ■

**Theorem 7.13** *With reference to Definition 7.8, let  $y \in \Gamma_2(x)$ . Then for each integer  $i$  ( $1 \leq i \leq D - 1$ ), each  $z \in \mathcal{D}_{i-1}^{i+1}$  (resp.  $\mathcal{D}_{i+1}^{i-1}$ ) is adjacent to*

- (a) precisely  $c_{i-1}$  vertices in  $\mathcal{D}_{i-2}^i$  (resp.  $\mathcal{D}_i^{i-2}$ ),
- (b) precisely  $b_{i+1}$  vertices in  $\mathcal{D}_i^{i+2}$  (resp.  $\mathcal{D}_{i+2}^i$ ),
- (c) precisely  $c_{i+1} - c_i$  vertices in  $\mathcal{D}_i^i(0)$ ,
- (d) precisely  $c_i - c_{i-1}$  vertices in  $\mathcal{D}_i^i(1)$ ,

and no other vertices in  $X$ .

PROOF. Immediate from [35, Lemma 3.11]. ■

**Theorem 7.14** *With reference to Definition 7.8, let  $y \in \Gamma_2(x)$ . Then the following (i)-(iv) hold.*

- (i) For each integer  $i$  ( $2 \leq i \leq f - 1$ ), each  $z \in \mathcal{D}_i^i = \mathcal{D}_i^i(1)$  is adjacent to
  - (a) precisely 1 vertex in  $\mathcal{D}_{i-1}^{i-1}(1)$ ,
  - (b) precisely  $k - 1$  vertices in  $\mathcal{D}_{i+1}^{i+1}(1)$ ,

and no other vertices in  $X$ .

(ii) Assume  $\ell \leq D - 2$ . Then for each integer  $i$  ( $\ell + 1 \leq i \leq D - 2$ ), each  $z \in \mathcal{D}_i^i = \mathcal{D}_i^i(0)$  is adjacent to

- (a) precisely  $k - 1$  vertices in  $\mathcal{D}_{i-1}^{i-1}(0)$ ,
- (b) precisely 1 vertex in  $\mathcal{D}_{i+1}^{i+1}(0)$ ,

and no other vertices in  $X$ .

(iii) Assume  $\ell \leq D - 2$ . Then each  $z \in \mathcal{D}_{D-1}^{D-1} = \mathcal{D}_{D-1}^{D-1}(0)$  is adjacent to

- (a) precisely 1 vertex in  $\mathcal{D}_D^{D-2}$ ,
- (b) precisely 1 vertex in  $\mathcal{D}_{D-2}^D$ ,
- (c) precisely  $k - 2$  vertices in  $\mathcal{D}_{D-2}^{D-2}(0)$ ,

and no other vertices in  $X$ .

(iv) If  $\mathcal{D}_D^D \neq \emptyset$ , then each  $z \in \mathcal{D}_D^D$  is adjacent to

- (a) precisely  $c_{D-1}$  vertices in  $\mathcal{D}_{D-1}^{D-1}(1)$ ,
- (b) precisely  $b_{D-1}$  vertices in  $\mathcal{D}_{D-1}^{D-1}(0)$ ,

and no other vertices in  $X$ .

PROOF. (i) Recall that  $c_{i-1} = c_i = 1$  by Lemma 6.6(i). Let  $w$  denote the common neighbour of  $x$  and  $y$ . Observe that  $\Gamma_{i-2}(w) \cap \Gamma(z) \subseteq \mathcal{D}_{i-1}^{i-1}$ , and so (a) above follows. As  $c_i = 1$ ,  $z$  has no neighbours in  $\mathcal{D}_{i-1}^{i+1} \cup \mathcal{D}_{i+1}^{i-1}$ , and (b) follows.

(ii) Similar to the proof of (i) above.

(iii) First note that since  $\ell \leq D - 2$  we have  $b_{D-1} = 1$ , and so  $\mathcal{D}_D^D = \emptyset$  by Corollary 3.7(v). As  $\Gamma(z) \cap \Gamma_D(y) \subseteq \mathcal{D}_D^{D-2}$ , (a) follows. Similarly, as  $\Gamma(z) \cap \Gamma_D(x) \subseteq \mathcal{D}_{D-2}^D$ , (b) follows. Claim (c) is now clear.

(iv) Note that  $\Gamma_{D-2}(w) \cap \Gamma(z) \subseteq \mathcal{D}_{D-1}^{D-1}(1)$ , and so (a) follows. As  $\Gamma(z) \subseteq \mathcal{D}_{D-1}^{D-1}$ , (b) is now clear.  $\blacksquare$

**Theorem 7.15** *With reference to Definition 7.8, let  $y \in \Gamma_2(x)$ . Then the following (i), (ii) hold.*

(i) For each integer  $i$  ( $f \leq i \leq \ell$ ), each  $z \in \mathcal{D}_i^i(0)$  is adjacent to

- (a) precisely  $b_{i+1}$  vertices in  $\mathcal{D}_{i+1}^{i+1}(0)$ ,
- (b) precisely  $\frac{c_i(c_{i+1} - c_i)}{c_{i+1} - 1}$  vertices in  $\mathcal{D}_{i+1}^{i-1}$ ,
- (c) precisely  $\frac{c_i(c_{i+1} - c_i)}{c_{i+1} - 1}$  vertices in  $\mathcal{D}_{i-1}^{i+1}$ ,
- (d) precisely  $\frac{(c_i - c_{i+1})(c_i - c_{i+1} + 1)}{c_{i+1} - 1}$  vertices in  $\mathcal{D}_{i+1}^{i+1}(1)$ ,
- (e) precisely  $\frac{c_i(c_i - 1)}{c_{i+1} - 1}$  vertices in  $\mathcal{D}_{i-1}^{i-1}(0)$ ,

and no other vertices in  $X$ .

(ii) For each integer  $i$  ( $f \leq i \leq \ell$ ), each  $z \in \mathcal{D}_i^i(1)$  is adjacent to

- (a) precisely  $c_{i-1}$  vertices in  $\mathcal{D}_{i-1}^{i-1}(1)$ ,
- (b) precisely  $\frac{b_i(c_i - c_{i-1})}{b_{i-1} - 1}$  vertices in  $\mathcal{D}_{i-1}^{i+1}$ ,

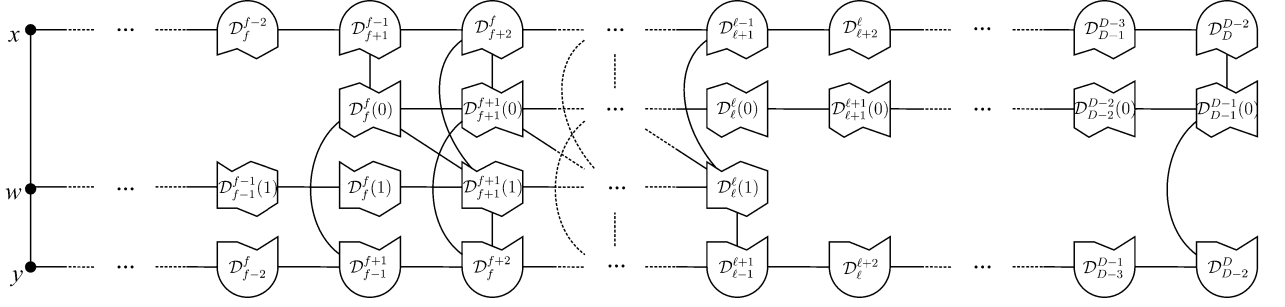

**Figure 7.1.** The partition with reference to Definition 7.8, when  $\ell \leq D - 2$ . Observe that  $\Gamma_i(x) = \mathcal{D}_{i+2}^i \cup \mathcal{D}_i^i(0) \cup \mathcal{D}_i^i(1) \cup \mathcal{D}_{i-2}^i$  and  $\Gamma_i(y) = \mathcal{D}_i^{i-2} \cup \mathcal{D}_i^i(0) \cup \mathcal{D}_i^i(1) \cup \mathcal{D}_i^{i+2}$  ( $2 \leq i \leq D$ ).

- (c) precisely  $\frac{b_i(c_i - c_{i-1})}{b_{i-1} - 1}$  vertices in  $\mathcal{D}_{i+1}^{i-1}$ ,
- (d) precisely  $\frac{(c_{i-1} - c_i)(c_{i-1} - c_i + 1)}{b_{i-1} - 1}$  vertices in  $\mathcal{D}_{i-1}^{i-1}(0)$ ,
- (e) precisely  $\frac{b_i(b_i - 1)}{b_{i-1} - 1}$  vertices in  $\mathcal{D}_{i+1}^{i+1}(1)$ ,

and no other vertices in  $X$ .

PROOF. Immediate from Lemma 7.12 and [35, Lemma 3.11]. ■

**Corollary 7.16** *With reference to Definition 7.8, the following (i), (ii) hold for  $f \leq i \leq \ell$ .*

- (i)  $c_{i+1} - 1$  divides  $c_i(c_i - 1)$ .
- (ii)  $b_{i-1} - 1$  divides  $b_i(b_i - 1)$ .

PROOF. Immediate from Lemma 7.12. ■

## 7.3 Some products in $T$

With reference to Definition 7.8, in this section we evaluate several products in the Terwilliger algebra which we shall need later.

**Lemma 7.17** *With reference to Definition 7.8, for arbitrary  $u, y \in X$  and  $2 \leq i \leq D$  the following holds:*

$$\left( E_i^*(A_{i-1}E_1^*A - A_{i-2})E_2^* \right)_{uy} = \begin{cases} 1 & \text{if } \partial(x, y) = 2 \text{ and } u \in \mathcal{D}_i^i(1), \\ 0 & \text{otherwise.} \end{cases}$$

PROOF. Note that

$$\begin{aligned} & \left( E_i^*(A_{i-1}E_1^*A - A_{i-2})E_2^* \right)_{uy} = \\ & = \left( E_i^*A_{i-1}E_1^*AE_2^* \right)_{uy} - \left( E_i^*A_{i-2}E_2^* \right)_{uy} \end{aligned}$$

By Lemma 5.20,  $(E_i^*A_{i-2}E_2^*)_{uy} = 1$  if  $\partial(x, u) = i$ ,  $\partial(u, y) = i - 2$  and  $\partial(x, y) = 2$ , and 0 otherwise. By Lemma 5.21,  $(E_i^*A_{i-1}E_1^*AE_2^*)_{uy} = |\Gamma(x) \cap \Gamma(y) \cap \Gamma_{i-1}(u)|$  if  $\partial(x, u) = i$  and  $\partial(x, y) = 2$ , and 0 otherwise. Therefore, the lemma holds if  $\partial(x, u) \neq i$  or  $\partial(x, y) \neq 2$ .

Assume now  $\partial(x, u) = i$  and  $\partial(x, y) = 2$ , and let  $w$  denote the common neighbour of  $x$  and  $y$ . Note that, since  $\partial(x, u) = i$ , we have  $\partial(u, y) \in \{i-2, i, i+2\}$ . If  $\partial(u, y) \in \{i-2, i+2\}$  then it follows from the above comments that  $(E_i^*(A_{i-1}E_1^*A - A_{i-2})E_2^*)_{uy} = 0$ . Therefore, assume in addition that  $\partial(u, y) = i$ , and so  $(E_i^*A_{i-2}E_2^*)_{uy} = 0$ . Observe that  $(E_i^*A_{i-1}E_1^*AE_2^*)_{uy} = 1$  if and only if  $u \in \mathcal{D}_i^i(1)$ , and the result follows.  $\blacksquare$

**Lemma 7.18** *With reference to Definition 7.8, for arbitrary  $u, y \in X$  and  $2 \leq i \leq D$  the following holds:*

$$\left(E_i^*(A_i - A_{i-1}E_1^*A + A_{i-2})E_2^*\right)_{uy} = \begin{cases} 1 & \text{if } \partial(x, y) = 2 \text{ and } u \in \mathcal{D}_i^i(0), \\ 0 & \text{otherwise.} \end{cases}$$

PROOF. Immediate from Lemma 5.20 and Lemma 7.17.  $\blacksquare$

**Lemma 7.19** *With reference to Definition 7.8, the following (i)-(v) hold.*

(i)  $LE_2^* = E_1^*AE_2^*$ .

(ii) For  $3 \leq i \leq f$

$$LE_i^*A_{i-2}E_2^* = (k-1)E_{i-1}^*A_{i-3}E_2^*.$$

(iii) For  $f+1 \leq i \leq \ell+1$

$$\begin{aligned} LE_i^*A_{i-2}E_2^* &= \frac{c_{i-1}(c_i - c_{i-1})}{c_i - 1} E_{i-1}^*(A_{i-1} - A_{i-2}E_1^*A + A_{i-3})E_2^* + \\ &\quad + \frac{b_{i-1}(c_{i-1} - c_{i-2})}{b_{i-2} - 1} E_{i-1}^*(A_{i-2}E_1^*A - A_{i-3})E_2^* + \\ &\quad + b_{i-1}E_{i-1}^*A_{i-3}E_2^*. \end{aligned}$$

(iv) If  $\ell \leq D-2$ , then for  $\ell+2 \leq i \leq D-1$

$$LE_i^*A_{i-2}E_2^* = E_{i-1}^*A_{i-3}E_2^*$$

and

$$\begin{aligned} LE_D^*A_{D-2}E_2^* &= E_{D-1}^*(A_{D-1} - A_{D-2}E_1^*A + A_{D-3})E_2^* \\ &\quad + E_{D-1}^*A_{D-3}E_2^*. \end{aligned}$$

(v) For  $0 \leq i \leq D-2$

$$LE_i^*A_{i+2}E_2^* = b_{i+1}E_{i-1}^*A_{i+1}E_2^*.$$

PROOF. We will prove claim (iii). The proofs of the other claims are similar.

(iii) Choose  $u, y \in X$  and integer  $i$  ( $f+1 \leq i \leq \ell+1$ ). Note that by (5.8),  $LE_i^*A_{i-2}E_2^* = E_{i-1}^*AE_i^*A_{i-2}E_2^*$ . It follows from Lemmas 5.20, 5.21, 7.17 and 7.18, that the  $(u, y)$ -entries of both sides of the equation are 0 if  $\partial(x, y) \neq 2$  or  $\partial(x, u) \neq i-1$ .

Assume now  $\partial(x, y) = 2$  and  $\partial(x, u) = i-1$ . Observe that by Lemma 5.21, the number  $(LE_i^*A_{i-2}E_2^*)_{uy}$  is equal to the number of neighbours that  $u$  has in  $\mathcal{D}_{i-2}^i$ . Now Theorems 7.13, 7.14 and 7.15 yield that

$$(LE_i^*A_{i-2}E_2^*)_{uy} = \begin{cases} \frac{c_{i-1}(c_i - c_{i-1})}{c_i - 1} & \text{if } u \in \mathcal{D}_{i-1}^{i-1}(0), \\ \frac{b_{i-1}(c_{i-1} - c_{i-2})}{b_{i-2} - 1} & \text{if } u \in \mathcal{D}_{i-1}^{i-1}(1), \\ b_{i-1} & \text{if } u \in \mathcal{D}_{i-3}^{i-1}, \\ 0 & \text{if } u \in \mathcal{D}_{i+1}^{i-1}. \end{cases}$$

The result now follows from Lemma 5.20, Lemma 7.17 and Lemma 7.18.  $\blacksquare$

**Lemma 7.20** *With reference to Definition 7.8, the following (i)-(iv) hold.*

(i) For  $2 \leq i \leq D$

$$RE_i^* A_{i-2} E_2^* = c_{i-1} E_{i+1}^* A_{i-1} E_2^*.$$

(ii) For  $1 \leq i \leq f - 2$

$$RE_i^* A_{i+2} E_2^* = c_{i+1} E_{i+1}^* A_{i+3} E_2^*.$$

(iii) For  $f - 1 \leq i \leq \ell - 1$

$$\begin{aligned} RE_i^* A_{i+2} E_2^* &= c_{i+1} E_{i+1}^* A_{i+3} E_2^* \\ &\quad + \frac{b_{i+1}(c_{i+1} - c_i)}{b_i - 1} E_{i+1}^* (A_i E_1^* A - A_{i-1}) E_2^* \\ &\quad + \frac{c_{i+1}(c_{i+2} - c_{i+1})}{c_{i+2} - 1} E_{i+1}^* (A_{i+1} - A_i E_1^* A + A_{i-1}) E_2^*. \end{aligned}$$

(iv) If  $\ell \leq D - 2$  then for  $\ell \leq i \leq D - 3$

$$RE_i^* A_{i+2} E_2^* = (k - 1) E_{i+1}^* A_{i+3} E_2^*$$

and

$$RE_{D-2}^* A_D E_2^* = E_{D-1}^* (A_{D-1} - A_{D-2} E_1^* A + A_{D-3}) E_2^*.$$

PROOF. Similar to the proof of Lemma 7.19. ■

## 7.4 More products in $T$

**Lemma 7.21** *With reference to Definition 7.8, for  $y, z \in \Gamma_2(x)$  and  $2 \leq i \leq D$  the number  $|\Gamma_i(x) \cap \Gamma_{i-2}(y) \cap \Gamma_{i-2}(z)|$  is equal to  $k_i c_i c_{i-1} k^{-1} (k - 1)^{-1}$  if  $y = z$ ,  $k_i c_i c_{i-1} (c_{i-1} - 1) k^{-1} (k - 1)^{-1} (k - 2)^{-1}$  if  $\partial(y, z) = 2$ , and  $k_i c_i c_{i-1}^2 (c_i - 1) k^{-1} (k - 1)^{-3}$  if  $\partial(y, z) = 4$ .*

PROOF. If  $y = z$ , then  $|\Gamma_i(x) \cap \Gamma_{i-2}(y) \cap \Gamma_{i-2}(z)|$  is equal to  $p_{i,i-2}^2$ , and the result now follows from Corollary 3.7. Assume  $\partial(y, z) = 2$ . Abbreviate  $\mathcal{D}_j^h = \mathcal{D}_j^h(x, y)$  ( $0 \leq h, j \leq D$ ) and note that  $z \in \mathcal{D}_2^2$ . It follows from Theorems 7.13, 7.14, and 7.15 that the number of paths of length  $i - 2$  between  $z$  and  $\mathcal{D}_{i-2}^i$  is independent of  $z$ . Moreover, between any two vertices of  $\Gamma$  which are at distance  $i - 2$ , there exist exactly  $c_1 c_2 \cdots c_{i-2}$  paths of length  $i - 2$ . Therefore, the scalar  $|\mathcal{D}_{i-2}^i \cap \Gamma_{i-2}(z)|$  is independent of  $z$ ; denote this scalar by  $\psi_i$ . Note that, by the definition of  $\mathcal{D}_2^2(1) = \mathcal{D}_2^2$ , the lone vertex  $w$  in  $\mathcal{D}_1^1$  is adjacent to all vertices in  $\mathcal{D}_2^2$ . For  $v \in \mathcal{D}_{i-2}^i$  we have  $\partial(v, w) = i - 1$ . Thus for any  $v \in \mathcal{D}_{i-2}^i$ , there are precisely  $c_{i-1} - 1$  vertices in  $\mathcal{D}_2^2$  that are adjacent to  $w$  and distance  $i - 2$  from  $v$ . Using these comments we count in two ways the number of pairs  $(z, v)$  such that  $z \in \mathcal{D}_2^2$ ,  $v \in \mathcal{D}_{i-2}^i$ , and  $\partial(z, v) = i - 2$ . This yields  $\psi_i |\mathcal{D}_2^2| = |\mathcal{D}_{i-2}^i| (c_{i-1} - 1)$ . Thus  $\psi_i = p_{2,i-2}^2 (c_{i-1} - 1) (p_{22}^2)^{-1}$ . Using Corollary 3.7 and the fact that  $c_2 = c_3 = 1$ , we find  $\psi_i = k_i c_i c_{i-1} (c_{i-1} - 1) k^{-1} (k - 1)^{-1} (k - 2)^{-1}$ .

Now assume  $\partial(y, z) = 4$ , and use a similar argument. Again let  $\psi_i = |\mathcal{D}_{i-2}^i \cap \Gamma_{i-2}(z)|$ . Note that for any  $v \in \mathcal{D}_{i-2}^i$ , there are precisely  $c_{i-1} - 1$  vertices in  $\mathcal{D}_2^2$  that are distance  $i - 2$  from  $v$ , as we counted above. Hence there are precisely  $p_{2,i-2}^i - 1 - (c_{i-1} - 1)$  vertices in  $\mathcal{D}_4^2$  that are distance  $i - 2$  from  $v$ . Here we count in two ways the number of pairs  $(z, v)$  such that  $z \in \mathcal{D}_4^2$ ,  $v \in \mathcal{D}_{i-2}^i$ , and  $\partial(z, v) = i - 2$ . This yields  $\psi_i |\mathcal{D}_4^2| = |\mathcal{D}_{i-2}^i| (p_{2,i-2}^i - 1 - (c_{i-1} - 1))$ . Using Corollary 3.7 and the fact that  $c_2 = c_3 = 1$ , we obtain the desired result. ■

**Corollary 7.22** *With reference to Definition 7.8, for  $2 \leq i \leq D$  we have*

$$E_2^* A_{i-2} E_i^* A_{i-2} E_2^* = \frac{k_i c_i c_{i-1}}{k(k-1)} E_2^* + \frac{k_i c_i c_{i-1} (c_{i-1} - 1)}{k(k-1)(k-2)} E_2^* A_2 E_2^*$$



$$+ \frac{k_i c_i c_{i-1}^2 (c_i - 1)}{k(k-1)^3} E_2^* A_4 E_2^*.$$

PROOF. For  $y, z \in X$ , one verifies the  $(y, z)$ -entry of both sides are equal. If  $y \notin \Gamma_2(x)$  or  $z \notin \Gamma_2(x)$ , then the  $(y, z)$ -entry of each side is 0. If  $y, z \in \Gamma_2(x)$  then the  $(y, z)$ -entry of both sides are equal by Lemmas 5.20, 5.21, and 7.21. ■

**Lemma 7.23** *With reference to Definition 7.8, for  $y, z \in \Gamma_2(x)$  and  $2 \leq i \leq D - 2$  the number  $|\Gamma_i(x) \cap \Gamma_{i+2}(y) \cap \Gamma_{i-2}(z)|$  is equal to  $k_i b_i b_{i+1} c_i c_{i-1} k^{-1} (k-1)^{-3}$  if  $\partial(y, z) = 4$ , and 0 otherwise.*

PROOF. The result is clear if  $\partial(y, z) \in \{0, 2\}$ . Assume  $\partial(y, z) = 4$ . Abbreviate  $\mathcal{D}_j^h = \mathcal{D}_j^h(x, y)$  ( $0 \leq h, j \leq D$ ) and note that  $z \in \mathcal{D}_4^2$ . It follows from Theorems 7.13, 7.14, and 7.15 that the number of paths of length  $i - 2$  between  $z$  and  $\mathcal{D}_{i+2}^i$  is independent of  $z$ . Moreover, between any two vertices of  $\Gamma$  which are at distance  $i - 2$ , there exist exactly  $c_1 c_2 \cdots c_{i-2}$  paths of length  $i - 2$ . Therefore, the scalar  $|\mathcal{D}_{i+2}^i \cap \Gamma_{i-2}(z)|$  is independent of  $z$ ; denote this scalar by  $\psi_i$ . Here we count in two ways the number of pairs  $(z, v)$  such that  $z \in \mathcal{D}_4^2$ ,  $v \in \mathcal{D}_{i+2}^i$ , and  $\partial(z, v) = i - 2$ . This yields  $\psi_i |\mathcal{D}_4^2| = |\mathcal{D}_{i+2}^i| p_{2, i-2}^i$ . Thus  $\psi_i = p_{i, i+2}^2 p_{2, i-2}^i (p_{24}^2)^{-1}$ . Using Corollary 3.7 and the fact that  $c_2 = c_3 = 1$ , we obtain the desired result. ■

**Corollary 7.24** *With reference to Definition 7.8, for  $2 \leq i \leq D - 2$  we have*

$$E_2^* A_{i+2} E_i^* A_{i-2} E_2^* = \frac{k_i b_i b_{i+1} c_i c_{i-1}}{k(k-1)^3} E_2^* A_4 E_2^*.$$

PROOF. Similar to the proof of Corollary 7.22. ■

**Lemma 7.25** *With reference to Definition 7.8, for  $y, z \in \Gamma_2(x)$  and  $2 \leq i \leq D - 2$  the number  $|\Gamma_i(x) \cap \Gamma_{i+2}(y) \cap \Gamma_i(z)|$  is equal to 0 if  $y = z$ ,  $k_i b_i b_{i+1} (c_{i+1} - 1) k^{-1} (k-1)^{-1} (k-2)^{-1}$  if  $\partial(y, z) = 2$ , and  $k_i b_i b_{i+1} (c_i b_{i-1} + c_{i+1} (b_i - 1) - b_1) k^{-1} (k-1)^{-3}$  if  $\partial(y, z) = 4$ .*

PROOF. The result is clear if  $y = z$ . Now assume  $\partial(y, z) = 2$ . Abbreviate  $\mathcal{D}_j^h = \mathcal{D}_j^h(x, y)$  ( $0 \leq h, j \leq D$ ) and note that  $z \in \mathcal{D}_2^2$ . It follows from Theorems 7.13, 7.14, and 7.15 that the number of paths of length  $i$  between  $z$  and  $\mathcal{D}_{i+2}^i$  is independent of  $z$ . Moreover, between any two vertices of  $\Gamma$  which are at distance  $i$ , there exist exactly  $c_1 c_2 \cdots c_i$  paths of length  $i$ . Therefore, the scalar  $|\mathcal{D}_{i+2}^i \cap \Gamma_i(z)|$  is independent of  $z$ ; denote this scalar by  $\psi_i$ . Note the lone vertex  $w$  in  $\mathcal{D}_1^1$  is adjacent to all vertices in  $\mathcal{D}_2^2$ . For  $v \in \mathcal{D}_{i+2}^i$  we have  $\partial(v, w) = i + 1$ . Thus for any  $v \in \mathcal{D}_{i+2}^i$ , there are precisely  $b_{i+1} - 1$  vertices in  $\mathcal{D}_2^2$  that are adjacent to  $w$  and distance  $i + 2$  from  $v$ . Hence there are  $p_{22}^2 - (b_{i+1} - 1)$  vertices in  $\mathcal{D}_2^2$  that are distance  $i$  from  $v$ . Using these comments we count in two ways the number of pairs  $(z, v)$  such that  $z \in \mathcal{D}_2^2$ ,  $v \in \mathcal{D}_{i+2}^i$ , and  $\partial(z, v) = i$ . This yields  $\psi_i |\mathcal{D}_2^2| = |\mathcal{D}_{i+2}^i| (p_{22}^2 - (b_{i+1} - 1))$ . Thus  $\psi_i = p_{i, i+2}^2 (p_{22}^2 - (b_{i+1} - 1)) (p_{22}^2)^{-1}$ . Using Corollary 3.7, and the fact that  $c_2 = c_3 = 1$ , we find  $\psi_i = k_i b_i b_{i+1} (c_{i+1} - 1) k^{-1} (k-1)^{-1} (k-2)^{-1}$ .

Now assume  $\partial(y, z) = 4$ . Abbreviate  $\mathcal{D}_j^h = \mathcal{D}_j^h(x, y)$  ( $0 \leq h, j \leq D$ ) and note that  $z \in \mathcal{D}_2^4$ . It follows from Theorems 7.13, 7.14, and 7.15 that the number of walks of length  $i$  between  $z$  and  $\mathcal{D}_{i+2}^i$  is independent of  $z$ . Moreover, between any two vertices of  $\Gamma$  which are at distance  $i - 2$  (respectively,  $i$ ), there exist exactly  $c_1 c_2 \cdots c_{i-2} (b_0 c_1 + b_1 c_2 + \cdots + b_{i-2} c_{i-1})$  (respectively,  $c_1 c_2 \cdots c_i$ ) walks of length  $i$ . By this and Lemma 7.23, the scalar  $|\mathcal{D}_{i+2}^i \cap \Gamma_i(z)|$  is independent of  $z$ ; again, denote this scalar by  $\psi_i$ . Now let  $v \in \mathcal{D}_{i+2}^i$ . As above, there are precisely  $p_{22}^2 - (b_{i+1} - 1)$  vertices in  $\mathcal{D}_2^2$  that are distance  $i$  from  $v$ . Observe  $|\Gamma_i(v) \cap \Gamma_2(x)| = p_{2i}^i$ , so thus  $|\Gamma_i(v) \cap \mathcal{D}_4^2| = p_{2i}^i - (p_{22}^2 - (b_{i+1} - 1))$ . Using these comments we count in two ways the number of pairs  $(z, v)$  such that  $z \in \mathcal{D}_4^2$ ,  $v \in \mathcal{D}_{i+2}^i$ , and  $\partial(z, v) = i$ . This yields  $\psi_i |\mathcal{D}_4^2| = |\mathcal{D}_{i+2}^i| (p_{2i}^i - (p_{22}^2 - (b_{i+1} - 1)))$ . Thus  $\psi_i = p_{i, i+2}^2 (p_{2i}^i - p_{22}^2 + b_{i+1} - 1) (p_{24}^2)^{-1}$ . Using Corollary 3.7, and the fact that  $c_2 = c_3 = 1$ , we obtain the desired result. ■



**Corollary 7.26** *With reference to Definition 7.8, for  $2 \leq i \leq D - 2$  we have*

$$\begin{aligned} E_2^* A_{i+2} E_i^* A_i E_2^* &= \frac{k_i b_i b_{i+1} (c_{i+1} - 1)}{k(k-1)(k-2)} E_2^* A_2 E_2^* \\ &+ \frac{k_i b_i b_{i+1} (c_i b_{i-1} + c_{i+1} (b_i - 1) - b_1)}{k(k-1)^3} E_2^* A_4 E_2^*. \end{aligned}$$

PROOF. Similar to the proof of Corollary 7.22. ■

## 7.5 Some scalar products

In the remainder of the chapter, we will use the following notation.

**Definition 7.27** *With reference to Definition 7.8, let  $W$  denote an irreducible  $T$ -module with endpoint 2, and let  $v$  denote a nonzero vector in  $E_2^* W$ . For  $0 \leq i \leq D$ , define*

$$v_i^+ = E_i^* A_{i-2} v, \quad v_i^- = E_i^* A_{i+2} v. \quad (7.2)$$

Observe that  $v_2^+ = v$ ,  $v_i^+ = 0$  if  $i < 2$ , and  $v_i^- = 0$  if  $i < 2$  or  $i > D - 2$ . Moreover, by [10, Corollary 9.3(i)], we have

$$E_i^* A_i E_2^* v = -(v_i^+ + v_i^-) \quad (0 \leq i \leq D). \quad (7.3)$$

**Lemma 7.28** *With reference to Definition 7.8, let  $W$  denote an irreducible  $T$ -module with endpoint 2. Then  $JW = 0$ .*

PROOF. By [17, Propositions 8.3(ii), 8.4], the primary module is the unique irreducible  $T$ -module upon which  $J$  does not vanish. Since  $W$  is not the primary module, we have  $JW = 0$ . ■

**Lemma 7.29** *With reference to Definition 7.8, let  $W$  denote an irreducible  $T$ -module with endpoint 2, and let  $v \in E_2^* W$ . Then  $E_2^* A_2 E_2^* v = -v$ .*

PROOF. Observe that since  $E_2^* A_2 E_2^*$  is symmetric, it has an eigenbasis for  $E_2^* W$ . Furthermore, since  $\Delta_2 = 0$ , we know  $E_2^* A_2 E_2^*$  has exactly one distinct eigenvalue  $\eta$  on  $E_2^* W$  by [11, Corollary 4.13, Lemma 5.3]. Thus, every nonzero vector in  $E_2^* W$  is an eigenvector for  $E_2^* A_2 E_2^*$  with eigenvalue  $\eta$ . By [11, Lemmas 5.4, 5.5] and the fact that  $c_2 = 1$ , we find  $\eta = -1$ . The result follows. ■

**Lemma 7.30** *With reference to Definition 7.8, let  $W$  denote an irreducible  $T$ -module with endpoint 2, and let  $v \in E_2^* W$ . Then  $E_2^* A_4 E_2^* v = 0$ .*

PROOF. By Lemma 7.28, Lemma 5.20 and the fact that  $J = \sum A_i$ , we find

$$\begin{aligned} 0 = E_2^* J v &= E_2^* \left( \sum_{i=0}^D A_i \right) E_2^* v \\ &= E_2^* v + E_2^* A_2 E_2^* v + E_2^* A_4 E_2^* v. \end{aligned}$$

The result now follows by Lemma 7.29. ■

**Lemma 7.31** *With reference to Definition 7.8, let  $W$  denote an irreducible  $T$ -module with endpoint 2. With the notation of Definition 7.27, the following (i)–(iii) hold for any nonzero  $v \in E_2^* W$ .*

$$(i) \|v_i^+\|^2 = \frac{k_i c_i c_{i-1} (b_{i-1} - 1)}{k(k-1)(k-2)} \|v\|^2 \quad (2 \leq i \leq D).$$

$$(ii) \|v_i^-\|^2 = \frac{k_i b_i b_{i+1} (c_{i+1} - 1)}{k(k-1)(k-2)} \|v\|^2 \quad (2 \leq i \leq D-2).$$

$$(iii) \langle v_i^+, v_i^- \rangle = 0 \quad (2 \leq i \leq D-2).$$

PROOF. (i) Evaluating  $\|v_i^+\|^2 = \langle E_i^* A_{i-2} v, E_i^* A_{i-2} v \rangle$  using  $v = E_2^* v$ , (3.6), and Corollary 7.22, we find

$$\begin{aligned} \|v_i^+\|^2 &= \frac{k_i c_i c_{i-1}}{k(k-1)} \|v\|^2 + \frac{k_i c_i c_{i-1} (c_{i-1} - 1)}{k(k-1)(k-2)} \langle E_2^* A_2 E_2^* v, v \rangle \\ &\quad + \frac{k_i c_i c_{i-1}^2 (c_i - 1)}{k(k-1)^3} \langle E_2^* A_4 E_2^* v, v \rangle. \end{aligned}$$

The result now follows from Lemmas 7.29 and 7.30.

(ii) Using (7.3), we observe  $\|v_i^-\|^2 = \langle E_i^* A_{i+2} v, E_i^* A_{i+2} v \rangle = \langle -E_i^* A_{i-2} v - E_i^* A_i v, E_i^* A_{i+2} v \rangle$ . The rest of the proof is now similar to the proof of (i) above.

(iii) Similar to the proof of (i) above. ■

## 7.6 The irreducible $T$ -modules with endpoint 2

With reference to Definition 7.8, in this section we describe the irreducible  $T$ -modules with endpoint 2. We note that the case when  $\ell = D - 1$  is a special case. When  $\ell = D - 1$ , we have no information about  $b_{D-1}$ . The case when  $\ell = D - 1$  and  $b_{D-1} = 1$  behaves much like the case when  $\ell \leq D - 2$ . Thus, we will group these cases together. We will treat separately the case where  $\ell = D - 1$  and  $b_{D-1} \neq 1$ .

**Lemma 7.32** *With reference to Definition 7.8, assume either  $\ell \leq D - 2$ , or both  $\ell = D - 1$  and  $b_{D-1} = 1$ . Let  $W$  denote an irreducible  $T$ -module with endpoint 2. Then the following (i), (ii) hold for any nonzero  $v \in E_2^* W$ .*

(i) For  $2 \leq i \leq D$ ,  $v_i^+ \neq 0$  if and only if  $2 \leq i \leq \ell$ .

(ii) For  $2 \leq i \leq D - 2$ ,  $v_i^- \neq 0$  if and only if  $f \leq i \leq D - 2$ .

PROOF. Immediate from Lemmas 6.6 and 7.31. ■

**Lemma 7.33** *With reference to Definition 7.8, assume  $\ell = D - 1$  and  $b_{D-1} \neq 1$ . Let  $W$  denote an irreducible  $T$ -module with endpoint 2. Then the following (i), (ii) hold for any nonzero  $v \in E_2^* W$ .*

(i) For  $2 \leq i \leq D$ ,  $v_i^+ \neq 0$ .

(ii) For  $2 \leq i \leq D - 2$ ,  $v_i^- \neq 0$  if and only if  $f \leq i \leq D - 2$ .

PROOF. Immediate from Lemmas 6.6 and 7.31. ■

**Theorem 7.34** *With reference to Definition 7.8, let  $W$  denote an irreducible  $T$ -module with endpoint 2 and fix a nonzero  $v \in E_2^* W$ . Then the following (i), (ii) hold below.*

(i) Assume either  $\ell \leq D - 2$ , or both  $\ell = D - 1$  and  $b_{D-1} = 1$ . Then the following is a basis for  $W$ :

$$v_i^+ \quad (2 \leq i \leq \ell), \quad v_i^- \quad (f \leq i \leq D - 2). \quad (7.4)$$

(ii) Assume  $\ell = D - 1$  and  $b_{D-1} \neq 1$ . Then the following is a basis for  $W$ :

$$v_i^+ \quad (2 \leq i \leq D), \quad v_i^- \quad (f \leq i \leq D - 2). \quad (7.5)$$

PROOF. (i) We first show that  $W$  is spanned by the vectors (7.4). Let  $W'$  denote the subspace of  $V$  spanned by the vectors (7.4) and note that  $W' \subseteq W$ . We claim that  $W'$  is a  $T$ -module. By construction  $W'$  is  $M^*$ -invariant. First we observe  $E_1^*AE_2^*v = 0$  since  $W$  has endpoint 2. It now follows from (7.3) and Lemmas 7.19, 7.20, 7.29 that  $W'$  is invariant under  $L$  and  $R$ . Recall that  $A = L + R$  and  $A$  generates  $M$  so  $W'$  is  $M$ -invariant. The claim follows. Note that  $W' \neq 0$  since  $v \in W'$  so  $W' = W$  by the irreducibility of  $W$ .

Moreover, the vectors (7.4) are nonzero by Lemma 7.32, and linearly independent since they are mutually orthogonal by (5.5) and Lemma 7.31(iii). The result follows.

(ii) Similar. ■

## 7.7 The irreducible $T$ -modules with endpoint 2: the $A$ -action

With reference to Definition 7.8, let  $W$  denote an irreducible  $T$ -module with endpoint 2. In this section, we display the action of  $A$  on the basis for  $W$  given in Theorem 7.34. Since  $A = L + R$ , it suffices to give the actions of  $L, R$  on this basis.

**Lemma 7.35** *With reference to Definition 7.8, let  $W$  denote an irreducible  $T$ -module with endpoint 2. Assume either  $\ell \leq D - 2$ , or both  $\ell = D - 1$  and  $b_{D-1} = 1$ . Then the following (i)–(v) hold for all nonzero  $v \in E_2^*W$ .*

(i)  $Lv_2^+ = 0$ .

(ii)  $Lv_i^+ = (k - 1)v_{i-1}^+ \quad (3 \leq i \leq f)$ .

(iii)  $Lv_i^+ = \frac{b_{i-1}(b_{i-1} - 1)}{b_{i-2} - 1}v_{i-1}^+ + \frac{c_{i-1}(c_{i-1} - c_i)}{c_i - 1}v_{i-1}^- \quad (f + 1 \leq i \leq \ell)$ .

(iv)  $Lv_f^- = 0$ .

(v)  $Lv_i^- = b_{i+1}v_{i-1}^- \quad (f + 1 \leq i \leq D - 2)$ .

PROOF. First observe that  $E_1^*AE_2^*v = 0$ , since  $W$  has endpoint 2. Applying the equations in Lemma 7.19 to  $v$ , and using (7.3), we obtain the desired result. ■

**Lemma 7.36** *With reference to Definition 7.8, let  $W$  denote an irreducible  $T$ -module with endpoint 2. Assume either  $\ell \leq D - 2$ , or both  $\ell = D - 1$  and  $b_{D-1} = 1$ . Then the following (i)–(iv) hold for all nonzero  $v \in E_2^*W$ .*

(i)  $Rv_i^+ = c_{i-1}v_{i+1}^+ \quad (2 \leq i \leq \ell - 1)$ .

(ii)  $Rv_\ell^+ = 0$ .

(iii)  $Rv_i^- = \frac{b_{i+1}(c_i - c_{i+1})}{b_i - 1}v_{i+1}^+ + \frac{c_{i+1}(c_{i+1} - 1)}{c_{i+2} - 1}v_{i+1}^- \quad (f \leq i \leq \ell - 1)$ .

(iv) *If  $\ell \leq D - 2$ , then  $Rv_i^- = (k - 1)v_{i+1}^- \quad (\ell \leq i \leq D - 3)$ , and  $Rv_{D-2}^- = 0$ .*

PROOF. First observe that  $E_1^*AE_2^*v = 0$ , since  $W$  has endpoint 2. Applying the equations in Lemma 7.20 to  $v$ , and using (7.3), we obtain the desired result. ■

**Lemma 7.37** *With reference to Definition 7.8, let  $W$  denote an irreducible  $T$ -module with endpoint 2. Assume  $\ell = D - 1$  and  $b_{D-1} \neq 1$ . Then the following (i)–(v) hold for all nonzero  $v \in E_2^*W$ .*

- (i)  $Lv_2^+ = 0$ .
- (ii)  $Lv_i^+ = (k - 1)v_{i-1}^+ \quad (3 \leq i \leq f)$ .
- (iii)  $Lv_i^+ = \frac{b_{i-1}(b_{i-1} - 1)}{b_{i-2} - 1}v_{i-1}^+ + \frac{c_{i-1}(c_{i-1} - c_i)}{c_i - 1}v_{i-1}^- \quad (f + 1 \leq i \leq D)$ .
- (iv)  $Lv_f^- = 0$ .
- (v)  $Lv_i^- = b_{i+1}v_{i-1}^- \quad (f + 1 \leq i \leq D - 2)$ .

PROOF. Similar to the proof of Lemma 7.35. ■

**Lemma 7.38** *With reference to Definition 7.8, let  $W$  denote an irreducible  $T$ -module with endpoint 2. Assume  $\ell = D - 1$  and  $b_{D-1} \neq 1$ . Then the following (i)–(iii) hold for all nonzero  $v \in E_2^*W$ .*

- (i)  $Rv_i^+ = c_{i-1}v_{i+1}^+ \quad (2 \leq i \leq D - 1)$ .
- (ii)  $Rv_D^+ = 0$ .
- (iii)  $Rv_i^- = \frac{b_{i+1}(c_i - c_{i+1})}{b_i - 1}v_{i+1}^+ + \frac{c_{i+1}(c_{i+1} - 1)}{c_{i+2} - 1}v_{i+1}^- \quad (f \leq i \leq D - 2)$ ,

where  $v_{D-1}^- = 0$ .

PROOF. Similar to the proof of Lemma 7.36. ■

## 7.8 The isomorphism class of an irreducible $T$ -module with endpoint 2

With reference to Definition 7.8, in this section we prove that up to isomorphism there exists exactly one irreducible  $T$ -module with endpoint 2.

**Theorem 7.39** *With reference to Definition 7.8, any two irreducible  $T$ -modules with endpoint 2 are isomorphic.*

PROOF. First assume  $\ell \leq D - 2$ . Let  $W$  and  $W'$  denote irreducible  $T$ -modules with endpoint 2. Fix nonzero  $v \in E_2^*W$ ,  $v' \in E_2^*W'$ . By Theorem 7.34,  $W$  has basis  $\{E_i^*A_{i-2}v \mid 2 \leq i \leq \ell\} \cup \{E_i^*A_{i+2}v \mid f \leq i \leq D - 2\}$ , and  $W'$  has basis  $\{E_i^*A_{i-2}v' \mid 2 \leq i \leq \ell\} \cup \{E_i^*A_{i+2}v' \mid f \leq i \leq D - 2\}$ . Let  $\sigma : W \rightarrow W'$  denote the vector space isomorphism defined by  $\sigma(E_i^*A_{i-2}v) = E_i^*A_{i-2}v'$  ( $2 \leq i \leq \ell$ ) and  $\sigma(E_i^*A_{i+2}v) = E_i^*A_{i+2}v'$  ( $f \leq i \leq D - 2$ ). We show that  $\sigma$  is a  $T$ -module isomorphism. Since  $A$  generates  $M$  and  $E_0^*, E_1^*, \dots, E_D^*$  is a basis for  $M^*$ , it suffices to show  $\sigma$  commutes with each of  $A, E_0^*, E_1^*, \dots, E_D^*$ .

Using (eiv) and the definition of  $\sigma$  we immediately find that  $\sigma$  commutes with each of  $E_0^*, E_1^*, \dots, E_D^*$ . It follows from Lemmas 7.35, 7.36 that  $\sigma$  commutes with each of  $L, R$ . Recall  $A = L + R$  so  $\sigma$  commutes with  $A$ . The result follows.

The case when  $\ell = D - 1$  is similar. ■

## On the Terwilliger algebra of a bipartite DRG with $c_2 = 2$

Let  $\Gamma$  denote a bipartite distance-regular graph with diameter  $D \geq 4$  and valency  $k \geq 3$ . Let  $X$  denote the vertex set of  $\Gamma$ , and let  $A$  denote the adjacency matrix of  $\Gamma$ . For  $x \in X$  and for  $0 \leq i \leq D$ , let  $\Gamma_i(x)$  denote the set of vertices in  $X$  that are distance  $i$  from vertex  $x$ . Define a parameter  $\Delta_2$  in terms of the intersection numbers by  $\Delta_2 = (k-2)(c_3-1) - (c_2-1)p_{22}^2$ . From Theorem 6.4 it is known that  $\Delta_2 = 0$  implies that  $D \leq 5$  or  $c_2 \in \{1, 2\}$ .

For  $x \in X$  let  $T = T(x)$  denote the subalgebra of  $\text{Mat}_X(\mathbb{C})$  generated by  $A, E_0^*, E_1^*, \dots, E_D^*$ , where for  $0 \leq i \leq D$ ,  $E_i^*$  represents the projection onto the  $i$ th subconstituent of  $\Gamma$  with respect to  $x$ .

In this chapter we find the structure of irreducible  $T$ -modules of endpoint 2 for graphs  $\Gamma$  which have the property that for  $2 \leq i \leq D-1$ , there exist complex scalars  $\alpha_i, \beta_i$  such that for all  $x, y, z \in X$  with  $\partial(x, y) = 2, \partial(x, z) = i, \partial(y, z) = i$ , we have  $\alpha_i + \beta_i |\Gamma_1(x) \cap \Gamma_1(y) \cap \Gamma_{i-1}(z)| = |\Gamma_{i-1}(x) \cap \Gamma_{i-1}(y) \cap \Gamma_1(z)|$ , in case when  $\Delta_2 = 0$  and  $c_2 = 2$ . The case when  $\Delta_2 = 0$  and  $c_2 = 1$  has already been studied in Chapter 7.

We show that if  $\Gamma$  is not almost 2-homogeneous, then up to isomorphism there exists exactly one irreducible  $T$ -module with endpoint 2 and it is not thin. We give a basis for this  $T$ -module, and we give the action of  $A$  on this basis. The results of this chapter are published in the journal “Discrete mathematics 340” (see [43]).

### 8.1 The sets $\mathcal{D}_j^i, \mathcal{D}_i^i(0), \mathcal{D}_i^i(1)$ and $\mathcal{D}_i^i(2)$

In this section we introduce a certain partition of the vertex set  $X$  of  $\Gamma$ .

**Definition 8.1** Let  $\Gamma = (X, \mathcal{R})$  denote a bipartite distance-regular graph with diameter  $D \geq 4$ , valency  $k \geq 3$  and intersection numbers  $b_i, c_i$ . Pick arbitrary vertex  $x \in X$ . For any  $y \in \Gamma_2(x)$  and for all integers  $i, j$  we define  $\mathcal{D}_j^i = \mathcal{D}_j^i(x, y)$  by

$$\mathcal{D}_j^i := \Gamma_{ij}(x, y) = \Gamma_i(x) \cap \Gamma_j(y).$$

We observe  $\mathcal{D}_j^i = \emptyset$  unless  $0 \leq i, j \leq D$  and either  $i = j$  or  $|i - j| = 2$ . Moreover,  $|\mathcal{D}_j^i| = p_{ij}^2$ .

**Lemma 8.2** *With reference to Definition 8.1, let  $y \in \Gamma_2(x)$ . Assume that  $c_2 = 2$  and let  $\bar{x}, \bar{y}$  denote the common neighbours of  $x$  and  $y$ . If  $w \in \mathcal{D}_i^i$  then  $\partial\{\bar{x}, w\} \in \{i-1, i+1\}$  and  $\partial\{\bar{y}, w\} \in \{i-1, i+1\}$ . If  $w \in \mathcal{D}_{i+1}^{i-1} \cup \mathcal{D}_{i-1}^{i+1}$  then  $\partial\{\bar{x}, w\} = i$  and  $\partial\{\bar{y}, w\} = i$ .*

PROOF. Routine. ■

**Definition 8.3** With reference to Definition 8.1, let  $y \in \Gamma_2(x)$ . Assume that  $c_2 = 2$  and let  $\bar{x}, \bar{y}$  denote the common neighbours of  $x$  and  $y$ . For all integers  $i$  define sets  $\mathcal{D}_i^i(0) = \mathcal{D}_i^i(0)(x, y)$ ,  $\mathcal{D}_i^i(1)' = \mathcal{D}_i^i(1)'(x, y)$ ,  $\mathcal{D}_i^i(1)'' = \mathcal{D}_i^i(1)''(x, y)$ ,  $\mathcal{D}_i^i(1) = \mathcal{D}_i^i(1)(x, y)$  and  $\mathcal{D}_i^i(2) = \mathcal{D}_i^i(2)(x, y)$  by

$$\begin{aligned}\mathcal{D}_i^i(0) &= \{w \in \mathcal{D}_i^i \mid \partial(\bar{x}, w) = i + 1, \partial(\bar{y}, w) = i + 1\}, \\ \mathcal{D}_i^i(1)' &= \{w \in \mathcal{D}_i^i \mid \partial(\bar{x}, w) = i - 1, \partial(\bar{y}, w) = i + 1\}, \\ \mathcal{D}_i^i(1)'' &= \{w \in \mathcal{D}_i^i \mid \partial(\bar{x}, w) = i + 1, \partial(\bar{y}, w) = i - 1\}, \\ \mathcal{D}_i^i(1) &= \mathcal{D}_i^i(1)' \cup \mathcal{D}_i^i(1)''\end{aligned}$$

and

$$\mathcal{D}_i^i(2) = \{w \in \mathcal{D}_i^i \mid \partial(\bar{x}, w) = i - 1, \partial(\bar{y}, w) = i - 1\}.$$

We observe that  $\mathcal{D}_i^i$  is disjoint union of  $\mathcal{D}_i^i(0)$ ,  $\mathcal{D}_i^i(1)$  and  $\mathcal{D}_i^i(2)$ . Also  $|\mathcal{D}_i^i(0) \cup \mathcal{D}_i^i(1) \cup \mathcal{D}_i^i(2)| = p_{ii}^2$  for  $0 \leq i \leq D$ , and there are no edges inside the set  $\bigcup_{h=0}^2 \mathcal{D}_i^i(h)$ .

**Remark 8.4** With reference to Definition 8.3, note that

$$\mathcal{D}_i^i(h) = \{z \in \mathcal{D}_i^i \mid |\Gamma_{i-1}(z) \cap \mathcal{D}_i^i| = h\} \quad \text{for } 0 \leq h \leq 2.$$

**Lemma 8.5** With reference to Definition 8.3, let  $y \in \Gamma_2(x)$ . Then we have  $\mathcal{D}_2^0 = \{x\}$ ,  $\mathcal{D}_0^2 = \{y\}$ ,  $\mathcal{D}_1^1(1)' = \{\bar{x}\}$ ,  $\mathcal{D}_1^1(1)'' = \{\bar{y}\}$ ,  $\mathcal{D}_1^1(0) = \emptyset$ ,  $\mathcal{D}_1^1(2) = \emptyset$  and  $\mathcal{D}_2^2(2) = \emptyset$ .

PROOF. It follows from Corollary 6.9(i) that  $\mathcal{D}_2^2(2) = \emptyset$ . The rest follow immediate from the definition of sets  $\mathcal{D}_j^j$  and  $\mathcal{D}_i^i(h)$  ( $0 \leq h \leq 2$ ). ■

**Lemma 8.6** With reference to Definition 8.3, let  $y \in \Gamma_2(x)$ . Then  $\mathcal{D}_{D-1}^{D-1}(0) = \Gamma_D(\bar{x}) \cap \Gamma_D(\bar{y})$  and  $\mathcal{D}_D^D(2) = \Gamma_D(x) \cap \Gamma_D(y) = \mathcal{D}_D^D$ .

PROOF. Immediate from Lemma 8.2 and Definition 8.3. ■

**Remark 8.7** With reference to Definition 8.3, note that  $\partial(\bar{x}, \bar{y}) = 2$  and that  $x, y$  are the common neighbours of  $\bar{x}, \bar{y}$ . Consequently, if we have a result that holds for  $x, y$  (and  $\bar{x}, \bar{y}$  as their common neighbours), then an analogous result for  $\bar{x}, \bar{y}$  (and  $x, y$  as their common neighbours) also holds (see Lemma 8.8 for more details). We will use this fact in the proof of Lemma 8.9(iii) and Lemma 8.21 claims (ii), (iv) and (vi).

**Lemma 8.8** (Chapter 4, Lemma 4.11) With reference to Definition 8.3, the following (i)–(iv) hold.

- (i)  $\mathcal{D}_{i+1}^{i-1}(x, y) = \mathcal{D}_i^i(1)'(\bar{x}, \bar{y})$  and  $\mathcal{D}_{i-1}^{i+1}(x, y) = \mathcal{D}_i^i(1)''(\bar{x}, \bar{y})$  for  $1 \leq i \leq D - 1$ .
- (ii)  $\mathcal{D}_i^i(0)(x, y) = \mathcal{D}_{i+1}^{i+1}(2)(\bar{x}, \bar{y})$  for  $1 \leq i \leq D - 1$ .
- (iii)  $\mathcal{D}_i^i(2)(x, y) = \mathcal{D}_{i-1}^{i-1}(0)(\bar{x}, \bar{y})$  for  $2 \leq i \leq D$ .
- (iv)  $\mathcal{D}_i^i(1)'(x, y) = \mathcal{D}_{i+1}^{i-1}(\bar{x}, \bar{y})$  and  $\mathcal{D}_i^i(1)''(x, y) = \mathcal{D}_{i-1}^{i+1}(\bar{x}, \bar{y})$  for  $1 \leq i \leq D - 1$ .

**Lemma 8.9** With reference to Definition 8.3, let  $y \in \Gamma_2(x)$ . For  $2 \leq i \leq D - 1$  the following (i)–(iii) hold.

- (i)  $|\mathcal{D}_{i+1}^{i-1}| = |\mathcal{D}_{i-1}^{i+1}| = p_{i-1, i+1}^2 = p_{i+1, i-1}^2 = \frac{b_2 b_3 \dots b_i}{c_1 c_2 \dots c_{i-1}}$ .

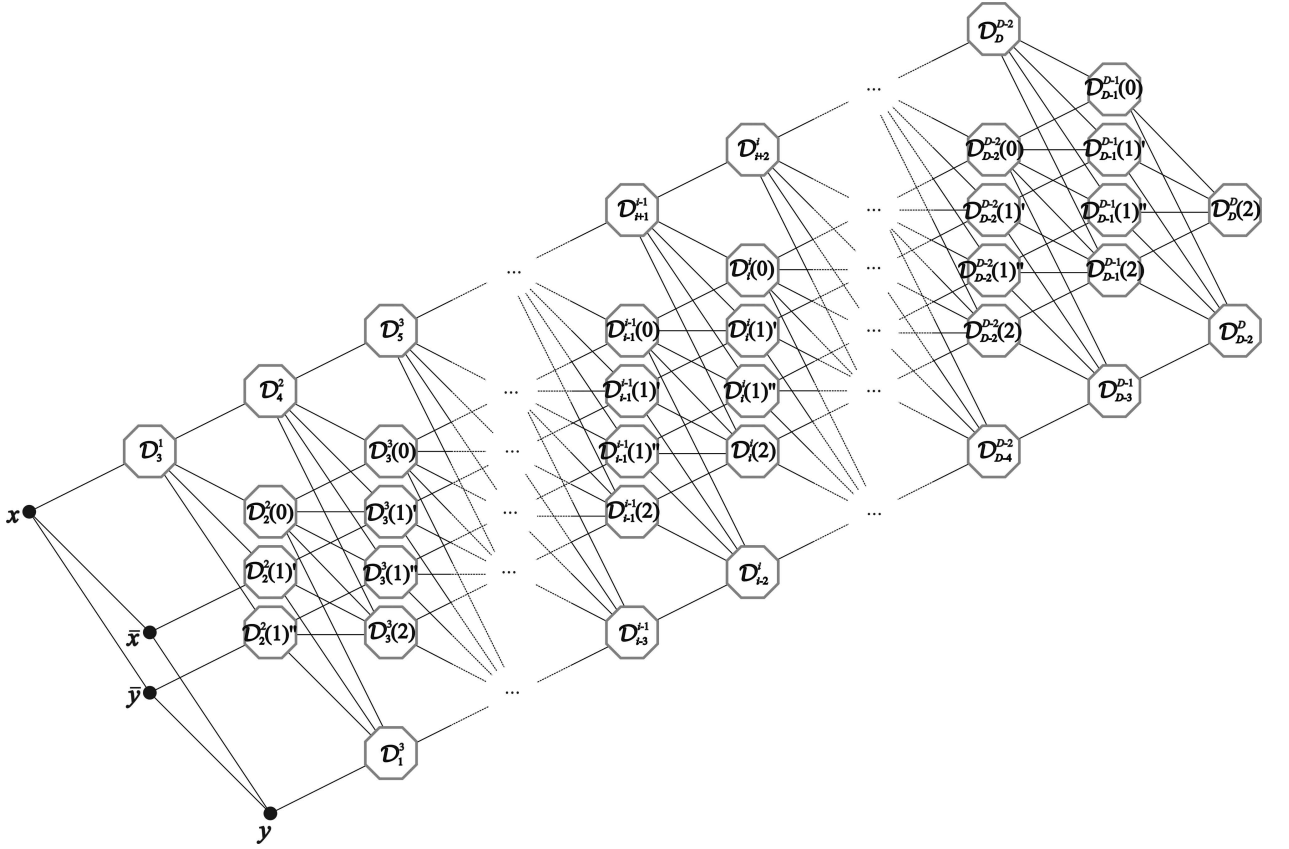

**Figure 8.1.** The partition of graph  $\Gamma$ , with reference to Definition 8.3. Observe that  $\Gamma_i(x) = \mathcal{D}_{i+2}^i \cup \mathcal{D}_i^i(0) \cup \mathcal{D}_i^i(1)' \cup \mathcal{D}_i^i(1)'' \cup \mathcal{D}_i^i(2) \cup \mathcal{D}_{i-2}^i$  (disjoint union) and  $\Gamma_i(y) = \mathcal{D}_i^{i-2} \cup \mathcal{D}_i^i(0) \cup \mathcal{D}_i^i(1)' \cup \mathcal{D}_i^i(1)'' \cup \mathcal{D}_i^i(2) \cup \mathcal{D}_i^{i+2}$  (disjoint union).

$$(ii) \quad |\mathcal{D}_i^i(1)'| = |\mathcal{D}_i^i(1)''| = p_{i-1, i+1}^2 = p_{i+1, i-1}^2 = \frac{b_2 b_3 \dots b_i}{c_1 c_2 \dots c_{i-1}}.$$

$$(iii) \quad |\mathcal{D}_i^i(0)| = |\mathcal{D}_{i+1}^{i+1}(2)| = \frac{b_2 b_3 \dots b_i}{c_1 c_2 \dots c_i} (c_{i+1} - c_i - 1).$$

PROOF. Claims (i) and (ii) follow immediately from Lemma 3.7(i). We will prove (iii) by mathematical induction.

Note that  $|\mathcal{D}_2^2| = p_{22}^2$  and that  $\mathcal{D}_2^2$  is disjoint union of  $\mathcal{D}_2^2(0)$ ,  $\mathcal{D}_2^2(1)'$  and  $\mathcal{D}_2^2(1)''$ . Using (ii) and Lemma 3.7(ii) we have  $|\mathcal{D}_2^2(0)| = p_{22}^2 - 2(k-2) = \frac{b_2}{c_2} (c_3 - c_2 - 1)$ . Now, just for a moment, let's interchange the role of  $x, y$  with the role of  $\bar{x}, \bar{y}$ . Then we have  $|\mathcal{D}_3^3(2)| = \frac{b_2}{c_2} (c_3 - c_2 - 1)$ .

Assume that  $|\mathcal{D}_i^i(0)| = |\mathcal{D}_{i+1}^{i+1}(2)| = \frac{b_2 b_3 \dots b_i}{c_1 c_2 \dots c_i} (c_{i+1} - c_i - 1)$  for  $2 \leq i \leq j$  (where  $j$  is some integer,  $j \in \{3, \dots, D-2\}$ ). We will show that claim (iii) holds for  $j+1$ . Since  $\mathcal{D}_{j+1}^{j+1}$  is disjoint union of  $\mathcal{D}_{j+1}^{j+1}(0)$ ,  $\mathcal{D}_{j+1}^{j+1}(1)'$ ,  $\mathcal{D}_{j+1}^{j+1}(1)''$  and  $\mathcal{D}_{j+1}^{j+1}(2)$  we have

$$\begin{aligned} |\mathcal{D}_{j+1}^{j+1}(0)| &= |\mathcal{D}_{j+1}^{j+1}| - |\mathcal{D}_{j+1}^{j+1}(1)'| - |\mathcal{D}_{j+1}^{j+1}(1)''| - |\mathcal{D}_{j+1}^{j+1}(2)| \\ &= p_{j+1, j+1}^2 - 2p_{j, j+2}^2 - \frac{b_2 b_3 \dots b_j}{c_1 c_2 \dots c_j} (c_{j+1} - c_j - 1). \end{aligned}$$

Now using Lemma 3.7 the results follow. ■

**Corollary 8.10** *With reference to Definitions 6.1 and 8.3, let  $y \in \Gamma_2(x)$ . For  $2 \leq i \leq D-1$  the following (i)–(iii) hold.*

$$(i) \quad \mathcal{D}_{i+1}^{i-1} \neq \emptyset, \mathcal{D}_{i-1}^{i+1} \neq \emptyset, \mathcal{D}_i^i(1)' \neq \emptyset \text{ and } \mathcal{D}_i^i(1)'' \neq \emptyset.$$



- (ii)  $c_{i+1} = c_i + 1$  if and only if  $\mathcal{D}_i^i(0) = \emptyset$  if and only if  $\mathcal{D}_{i+1}^{i+1}(2) = \emptyset$ .
- (iii)  $\Delta_i = 0$  if and only if  $\mathcal{D}_i^i(0) = \emptyset$  and  $\mathcal{D}_i^i(2) = \emptyset$ .

PROOF. Immediate from Lemma 6.8(ii) and Lemma 8.9. ■

**Lemma 8.11** *With reference to Definition 8.3, let  $y \in \Gamma_2(x)$ . For  $2 \leq i \leq D-1$  the following (i)–(iii) hold.*

- (i) *There is no edge between  $\mathcal{D}_i^i(0)$  and  $\mathcal{D}_{i-1}^{i-1}(1)' \cup \mathcal{D}_{i-1}^{i-1}(1)'' \cup \mathcal{D}_{i-1}^{i-1}(2)$ .*
- (ii) *There is no edge between  $\mathcal{D}_i^i(1)'$  and  $\mathcal{D}_{i-1}^{i-1}(1)'' \cup \mathcal{D}_{i-1}^{i-1}(2)$ .*
- (iii) *There is no edge between  $\mathcal{D}_i^i(1)''$  and  $\mathcal{D}_{i-1}^{i-1}(1)' \cup \mathcal{D}_{i-1}^{i-1}(2)$ .*

PROOF. Immediate from definition of sets  $\mathcal{D}_j^j$  and  $\mathcal{D}_i^i(h)$  ( $0 \leq h \leq 2$ ) (see Figure 1). ■

**Lemma 8.12** *With reference to Definition 8.3, let  $y \in \Gamma_2(x)$ . If there exists  $h$  ( $3 \leq h \leq D-1$ ) for which  $\mathcal{D}_{h-1}^{h-1}(0) \neq \emptyset$  and  $\mathcal{D}_h^h(0) = \emptyset$  then  $\mathcal{D}_i^i(0) = \emptyset$  and  $\mathcal{D}_{i+1}^{i+1}(2) = \emptyset$  for every  $i$  ( $h \leq i \leq D-1$ ).*

PROOF. Pick  $h$  for which  $\mathcal{D}_{h-1}^{h-1}(0) \neq \emptyset$  and  $\mathcal{D}_h^h(0) = \emptyset$ . Since  $\mathcal{D}_{h-1}^{h-1}(0) \neq \emptyset$  we have  $\mathcal{D}_h^h(2) \neq \emptyset$ , and  $\mathcal{D}_h^h(0) = \emptyset$  implies  $\mathcal{D}_{h+1}^{h+1}(2) = \emptyset$ . Pick arbitrary  $z \in \mathcal{D}_h^h(2)$ , and note that  $\Gamma_1(z) \cap \Gamma_{h+1}(y) \subseteq \mathcal{D}_{h+1}^{h-1}$ , so  $z$  has  $b_h$  neighbours in  $\mathcal{D}_{h+1}^{h-1}$ . On the other hand  $\mathcal{D}_{h+1}^{h-1}$  is a subset of  $\Gamma_{h-1}(x)$ , which implies that  $c_h \geq b_h$ . Moreover, since  $z$  must have at least one neighbour in  $\mathcal{D}_{h-1}^{h-1}$  we have  $c_h > b_h$ .

Now, assume that there is some  $s > h$  such that  $\mathcal{D}_i^i(0) = \emptyset$  (for  $h \leq i < s$ ) and  $\mathcal{D}_s^s(0) \neq \emptyset$ . Pick arbitrary  $w \in \mathcal{D}_s^s(0)$ . Note that  $\Gamma_1(w) \cap \Gamma_{s-1}(y) \subseteq \mathcal{D}_{s-1}^{s+1}$ , so  $w$  has  $c_s$  neighbours in  $\mathcal{D}_{s-1}^{s+1}$ . On the other hand we have that  $\mathcal{D}_{s-1}^{s+1}$  is a subset of  $\Gamma_{s+1}(x)$ , which implies that  $b_s \geq c_s$ . As  $h < s$  we have  $b_h < c_h \leq c_s \leq b_s$ . Thus  $h < s$  and  $b_h < b_s$ , a contradiction. ■

**Lemma 8.13** *With reference to Definitions 6.5 and 8.3, let  $y \in \Gamma_2(x)$ . Then the following (i)–(vi) hold.*

- (i)  $c_i = i$  for  $2 \leq i \leq f$ .
- (ii) If  $\ell \leq D-2$  then  $c_{i+1} = k - (D - i - 1)$  for  $\ell \leq i \leq D-1$ .
- (iii)  $f < \ell$  and  $\ell \geq \lceil \frac{D}{2} \rceil$ .
- (iv)  $\Delta_i \neq 0$  if and only if  $f \leq i \leq \ell$ .
- (v)  $\mathcal{D}_i^i(0) \neq \emptyset$  and  $\mathcal{D}_{i+1}^{i+1}(2) \neq \emptyset$  for  $f \leq i \leq \ell - 1$ ;  $\mathcal{D}_i^i(0) = \emptyset$  and  $\mathcal{D}_{i+1}^{i+1}(2) = \emptyset$  for  $2 \leq i \leq f - 1$ .
- (vi) If  $\ell \leq D-2$  then  $\mathcal{D}_i^i(0) = \emptyset$  and  $\mathcal{D}_{i+1}^{i+1}(2) = \emptyset$  for  $\ell \leq i \leq D-1$ .

PROOF. Claims (i) and (ii) follow immediately from Lemma 6.8(ii). Since  $\Delta_{f-1} = 0$  and  $\Delta_f \neq 0$  we have  $c_{f+1} - c_f - 1 \neq 0$ , which means that  $\Delta_{f+1} \neq 0$ . Therefore  $f < \ell$ . If  $\ell \leq \lfloor \frac{D}{2} \rfloor$ , then we can show that  $c_\ell > b_\ell$  (similarly as in the proof of Lemma 8.12). This is in contradiction with [3, Proposition 4.1.6]. Claims (iv), (v) and (vi) follow immediately from Lemma 8.12 and Corollary 8.10. ■

With reference to Definitions 6.5 and 8.3, let  $y \in \Gamma_2(x)$ . Note that if  $\ell = f + 1$  then the only nonempty cells among  $\mathcal{D}_i^i(0)$ ,  $\mathcal{D}_{i+1}^{i+1}(2)$  ( $2 \leq i \leq D-3$ ) are  $\mathcal{D}_f^f(0)$  and  $\mathcal{D}_{f+1}^{f+1}(2)$ . We will need Theorem 8.14 in Section 8.2.



**Theorem 8.14** *With reference to Definitions 6.5 and 8.3, let  $y \in \Gamma_2(x)$  and assume that  $\ell = f + 1$ . Then the partition of  $X$  into nonempty sets  $\mathcal{D}_{i+1}^{i-1}, \mathcal{D}_{i-1}^{i+1}, \mathcal{D}_i^i(1)', \mathcal{D}_i^i(1)''$  ( $1 \leq i \leq D - 1$ ),  $\mathcal{D}_f^f(0)$  and  $\mathcal{D}_{f+1}^{f+1}(2)$  is equitable. Moreover the corresponding parameters are independent of  $x, y$ .*

PROOF. Routine. (For example, each  $z \in \mathcal{D}_{f+1}^{f+1}(2)$  is adjacent to precisely  $c_f$  vertices in  $\mathcal{D}_f^f(1)''$ ,  $c_f$  vertices in  $\mathcal{D}_f^f(1)'$ ,  $b_{f+1}$  vertices in  $\mathcal{D}_f^{f+2}$ ,  $b_{f+1}$  vertices in  $\mathcal{D}_{f+2}^f$ ,  $c_{f+1} - 2c_f - b_{f+1}$  vertices in  $\mathcal{D}_f^f(0)$  and no other vertices in  $X$ .)  $\blacksquare$

## 8.2 Maps $G_i, H_i$ and $I_i$

In this section we introduce certain maps  $G_i, H_i, I_i$  ( $2 \leq i \leq D - 1$ ). We will later assume that these maps are linearly dependent.

**Definition 8.15** *With reference to Definition 8.1, let  $y \in \Gamma_2(x)$ . We define maps  $G_i, H_i, I_i : \mathcal{D}_i^i \rightarrow \mathbb{N} \cup \{0\}$  ( $2 \leq i \leq D - 1$ ) as follows. For  $z \in \mathcal{D}_i^i$  we let*

$$G_i(z) = |\Gamma_{i-1}(z) \cap \mathcal{D}_1^1|, \quad H_i(z) = |\Gamma_1(z) \cap \mathcal{D}_{i-1}^{i-1}|, \quad I_i(z) = 1.$$

With reference to Definition 8.15, our goal in this chapter is to describe the irreducible  $T$ -modules of endpoint 2 in the case when for every  $x \in X, y \in \Gamma_2(x)$  and for every  $i$  ( $2 \leq i \leq D - 1$ ) there exist complex scalars  $\alpha_i, \beta_i$  such that  $H_i = \alpha_i I_i + \beta_i G_i$ .

Assume the above dependency holds for every  $i$  ( $2 \leq i \leq D - 1$ ). If  $\Delta_2 > 0$ , then the irreducible  $T$ -modules with endpoint 2 were studied by MacLean and Miklavič (see [27, Theorem 9.6]). If  $\Delta_i = 0$  for  $2 \leq i \leq D - 2$ , then  $\Gamma$  is almost 2-homogeneous, and its irreducible  $T$ -modules with endpoint 2 are described in [12, Theorem 3.11]. In this chapter we therefore assume that  $\Delta_2 = 0$ , and that there exists some  $i$  ( $3 \leq i \leq D - 2$ ), such that  $\Delta_i \neq 0$ . Recall that, by Theorem 7.5, the above scalars  $\alpha_i, \beta_i$  are uniquely determined if  $\Delta_i \neq 0$ .

**Theorem 8.16** *With reference to Definitions 6.1, 8.3 and 8.15, pick arbitrary  $i$  ( $3 \leq i \leq D - 1$ ). Then the following (i), (ii) hold.*

- (i) *If  $\Delta_i = 0$  then  $H_i(z) = c_{i-1}$  and  $G_i(z) = 1$  for all  $z \in \mathcal{D}_i^i$ .*
- (ii) *Assume that there exist complex scalars  $\alpha_i, \beta_i$  such that  $H_i(z) = \alpha_i I_i(z) + \beta_i G_i(z)$ , for all  $z \in \mathcal{D}_i^i$ . If  $\Delta_i \neq 0$  then*

$$\alpha_i = \frac{c_i(k-2)(c_i - c_{i-1} - 1)}{2\Delta_i},$$

$$\beta_i = \frac{c_{i-1}b_i(c_{i+1} - c_i - 1) - c_i b_{i+1}(c_i - c_{i-1} - 1)}{2\Delta_i}.$$

PROOF. Since  $\Delta_i = 0$  if and only if  $\mathcal{D}_i^i(0) = \emptyset$  and  $\mathcal{D}_i^i(2) = \emptyset$ , for arbitrary  $z \in \mathcal{D}_i^i$  we have  $H_i(z) = c_{i-1}$  and  $G_i(z) = 1$  (see Figure 1). Thus (i) follows. Claim (ii) follows immediately from Theorem 7.5 and the fact that  $c_2 = 2$ .  $\blacksquare$

**Theorem 8.17** *With reference to Definitions 6.1, 8.3 and 8.15, assume that there exists some  $i$  ( $2 \leq i \leq D - 3$ ) such that only  $\Delta_i$  and  $\Delta_{i+1}$  are nonzero. Then for every  $j$  ( $3 \leq j \leq D - 1$ ) there exist complex scalars  $\alpha_j, \beta_j$  such that  $H_j(z) = \alpha_j I_j(z) + \beta_j G_j(z)$  for all  $z \in \mathcal{D}_j^j$ .*

PROOF. From the equitable partition of Theorem 8.14 it is not hard to compute that  $H_j = c_{j-1}G_j$  for every  $j$  ( $2 \leq j \leq i$ ),  $H_{i+1} = (k + 2c_{i+1} - 2c_{i+2})I_{i+1} + (c_{i+2} - k)G_{i+1}$  and  $H_j = c_{j-1}G_j$  for every  $j$  ( $i + 2 \leq j \leq D - 1$ ).  $\blacksquare$

### 8.3 Equitable partition

In this section we will introduce an equitable partition of the vertex set  $X$  of  $\Gamma$ , that we will need in Section 8.5. For the rest of this chapter we refer to the following definition.

**Definition 8.18** Let  $\Gamma = (X, \mathcal{R})$  denote a bipartite distance-regular graph with diameter  $D \geq 4$ , valency  $k \geq 3$  and intersection numbers  $c_i, b_i$ , with  $c_2 = 2$ . With reference to Definition 6.1, assume that  $\Delta_2 = 0$  and that  $\Delta_i \neq 0$  for at least one  $i$  ( $3 \leq i \leq D - 2$ ). Let

$$f = \min\{i \in \mathbb{N} \mid 3 \leq i \leq D - 2 \text{ and } \Delta_i \neq 0\},$$

$$\ell = \max\{i \in \mathbb{N} \mid 3 \leq i \leq D - 1 \text{ and } \Delta_i \neq 0\}.$$

We fix vertex  $x \in X$ , and for any  $y \in \Gamma_2(x)$  let  $\bar{x}, \bar{y}$  denote the common neighbours of  $x$  and  $y$ . For all integers  $i, j$  define sets  $\mathcal{D}_j^i = \mathcal{D}_j^i(x, y)$ ,  $\mathcal{D}_i^i(0) = \mathcal{D}_i^i(0)(x, y)$ ,  $\mathcal{D}_i^i(1) = \mathcal{D}_i^i(1)(x, y)$ ,  $\mathcal{D}_i^i(1)' = \mathcal{D}_i^i(1)'(x, y)$ ,  $\mathcal{D}_i^i(1)'' = \mathcal{D}_i^i(1)''(x, y)$ ,  $\mathcal{D}_i^i(2) = \mathcal{D}_i^i(2)(x, y)$  as in Definition 8.3. Assume that for  $f \leq i \leq \ell$  there exist complex scalars  $\alpha_i, \beta_i$  such that for all  $x \in X$  and  $y \in \Gamma_2(x)$ ,  $H_i = \alpha_i I_i + \beta_i G_i$ , where  $G_i, H_i, I_i$  are as in Definition 8.15.

**Remark 8.19** With reference to Definition 8.18, we note that for each integer  $i$  for which  $\Delta_i = 0$ , we have that  $G_i$  is a constant function by Lemma 6.3. Under our assumptions,  $\Delta_i = 0$  for  $2 \leq i \leq f - 1$  and for  $\ell + 1 \leq i \leq D - 1$ . From Theorem 8.16(i), we see that  $H_i$  is also a constant function for these same  $i$  values. Hence it follows that for every  $i$  ( $2 \leq i \leq D - 1$ ), there exist complex scalars  $\alpha_i, \beta_i$  such that  $H_i = \alpha_i I_i + \beta_i G_i$ . Also, note that by Theorem 8.16(i),  $\alpha_i + \beta_i = c_{i-1}$  if  $\Delta_i = 0$ .

**Example 8.20** Denote by  $\Gamma$  the Double coset graph of the binary Golay code [3, Section 11.3E]. The intersection array of this graph is  $\{23, 22, 21, 20, 3, 2, 1; 1, 2, 3, 20, 21, 22, 23\}$ . Easy computations give us  $\Delta_2 = 0$ ,  $\Delta_3 \neq 0$ ,  $\Delta_4 \neq 0$ ,  $\Delta_5 = 0$  and  $\Delta_6 = 0$ . Now, from Theorem 8.17, we see that  $\Gamma$  satisfies all conditions of Definition 8.18. Also, note that  $\Delta_2 = 0$  and  $\Delta_3 \neq 0$  yield that  $\Gamma$  is not  $Q$ -polynomial (for example, use (a.1) $\Leftrightarrow$ (a.5) or (a.2) $\Leftrightarrow$ (a.9), and the fact that a  $Q$ -polynomial graph  $\Gamma$  has at most two irreducible  $T$ -modules with endpoint 2, and they are both thin [5]).

**Lemma 8.21** *With reference to Definition 8.18, let  $y \in \Gamma_2(x)$ . Then the following (i)–(vi) hold.*

(i) *For every  $i$  ( $3 \leq i \leq D - 1$ ) and for every  $z \in \mathcal{D}_i^i(1)' \cup \mathcal{D}_i^i(1)''$ ,*

$$|\Gamma_1(z) \cap \mathcal{D}_{i-1}^{i-1}(0)| = \alpha_i + \beta_i - c_{i-1}.$$

(ii) *For every  $i$  ( $3 \leq i \leq D - 1$ ) and for every  $z \in \mathcal{D}_{i+1}^{i-1} \cup \mathcal{D}_{i-1}^{i+1}$ ,*

$$|\Gamma_1(z) \cap \mathcal{D}_i^i(2)| = \alpha_i + \beta_i - c_{i-1}.$$

(iii) *For every  $i$  ( $f + 1 \leq i \leq \ell - 1$ ) and for every  $z \in \mathcal{D}_i^i(0)$ ,*

$$|\Gamma_1(z) \cap \mathcal{D}_{i-1}^{i-1}(0)| = \alpha_i.$$

(iv) *For every  $i$  ( $f + 1 \leq i \leq \ell - 1$ ) and for every  $z \in \mathcal{D}_{i+1}^{i+1}(2)$ ,*

$$|\Gamma_1(z) \cap \mathcal{D}_i^i(2)| = \alpha_i.$$

(v) For every  $i$  ( $f + 1 \leq i \leq \ell - 1$ ) and for every  $z \in \mathcal{D}_i^i(2)$ ,

$$|\Gamma_1(z) \cap \mathcal{D}_{i+1}^{i+1}(2)| = b_i - (c_i - \alpha_i - 2\beta_i).$$

(vi) For every  $i$  ( $f + 1 \leq i \leq \ell - 1$ ) and for every  $z \in \mathcal{D}_{i-1}^{i-1}(0)$ ,

$$|\Gamma_1(z) \cap \mathcal{D}_i^i(0)| = b_i - (c_i - \alpha_i - 2\beta_i).$$

PROOF. We will prove claims (i) and (ii). The proofs of the other claims are similar.

(i) Pick arbitrary  $z \in \mathcal{D}_i^i(1)''$ , and consider sets of vertices  $\Gamma_{i-2}(\bar{y})$  and  $\Gamma_{i-1}(\bar{y})$ . Note that  $\mathcal{D}_{i-1}^{i-1}(1)'' \subseteq \Gamma_{i-2}(\bar{y})$ ,  $\mathcal{D}_i^i(1)'' \subseteq \Gamma_{i-1}(\bar{y})$ , and that  $z$  has exactly  $c_{i-1}$  neighbours in  $\Gamma_{i-2}(\bar{y})$ . But all neighbours of  $z$  in  $\Gamma_{i-2}(\bar{y})$  are in  $\mathcal{D}_{i-1}^{i-1}(1)''$  so  $z$  has exactly  $c_{i-1}$  neighbours in  $\mathcal{D}_{i-1}^{i-1}(1)''$ .

By construction  $G_i(z) = 1$ , so  $z$  has exactly  $\alpha_i + \beta_i$  neighbours in  $\mathcal{D}_i^i$ . Since  $\Gamma_1(z) \cap \mathcal{D}_i^i \subseteq \mathcal{D}_{i-1}^{i-1}(0) \cup \mathcal{D}_{i-1}^{i-1}(1)''$  the result follows. If  $z \in \mathcal{D}_i^i(1)'$  then the proof is similar.

(ii) Pick arbitrary  $z \in \mathcal{D}_{i+1}^{i-1}$  and consider sets  $\Gamma_{i-1}(\bar{x})$  and  $\Gamma_i(\bar{x})$ . Just for a moment, let's interchange the role between  $x, y$  and  $\bar{x}, \bar{y}$ . Now the result follows immediately from claim (i) and Lemma 8.8.  $\blacksquare$

**Theorem 8.22** *With reference to Definition 8.18, let  $y \in \Gamma_2(x)$ . Then the partition of  $X$  into nonempty sets  $\mathcal{D}_{i+1}^{i-1}$ ,  $\mathcal{D}_{i-1}^{i+1}$ ,  $\mathcal{D}_i^i(1)$  ( $1 \leq i \leq D - 1$ ) and  $\mathcal{D}_i^i(0)$ ,  $\mathcal{D}_{i+1}^{i+1}(2)$  ( $f \leq i \leq \ell - 1$ ) is equitable. Moreover the corresponding parameters are independent of  $x, y$ .*

PROOF. First consider partition of  $X$  into nonempty sets  $\mathcal{D}_{i+1}^{i-1}$ ,  $\mathcal{D}_{i-1}^{i+1}$ ,  $\mathcal{D}_i^i(1)'$ ,  $\mathcal{D}_i^i(1)''$  ( $1 \leq i \leq D - 1$ ) and  $\mathcal{D}_i^i(0)$ ,  $\mathcal{D}_{i+1}^{i+1}(2)$  ( $f \leq i \leq \ell - 1$ ). That this partition is equitable follows immediately from Corollary 8.10, Lemma 8.21 and Lemmas 4.15, 4.16, 4.17, 4.18. Since  $\mathcal{D}_i^i(1)'$  and  $\mathcal{D}_i^i(1)''$  have the same corresponding parameters and since  $\mathcal{D}_i^i(1) = \mathcal{D}_i^i(1)' \cup \mathcal{D}_i^i(1)''$ , the result follows.  $\blacksquare$

## 8.4 Some products in $T$

In this section we evaluate several products in the Terwilliger algebra which we shall need later.

**Definition 8.23** Let  $\Gamma = (X, \mathcal{R})$  denote a bipartite distance-regular graph with diameter  $D \geq 4$ , valency  $k \geq 4$ , intersection numbers  $b_i, c_i$ , distance matrices  $A_i$  ( $0 \leq i \leq D$ ) and Bose-Mesner algebra  $M$ .  $V$  will denote the standard module for  $X$ . We fix  $x \in X$  and then suppress it in notation, writing  $E_i^* = E_i^*(x)$  ( $0 \leq i \leq D$ ),  $M^* = M^*(x)$  and  $T = T(x)$  for the dual idempotents with respect to  $x$ , the dual Bose-Mesner algebra with respect to  $x$  and the Terwilliger algebra with respect to  $x$ , respectively.

**Definition 8.24** With reference to Definitions 8.18 and 8.23, for arbitrary  $y, z \in X$  and for all integers  $1 \leq i \leq D$ ,  $0 \leq h \leq 2$  define matrices  $B_h^i$  by

$$(B_h^i)_{zy} = \begin{cases} 1 & \text{if } \partial(x, y) = 2 \text{ and } z \in \mathcal{D}_i^i(h), \\ 0 & \text{otherwise.} \end{cases}$$

**Lemma 8.25** *With reference to Definition 8.24, for arbitrary  $z, y \in X$  and for  $2 \leq i \leq D - 1$  the following (i)–(vii) hold.*

$$(i) (E_{i-1}^* A_{i+1} E_2^*)_{zy} = \begin{cases} 1 & \text{if } \partial(x, y) = 2 \text{ and } z \in \mathcal{D}_{i+1}^{i-1}, \\ 0 & \text{otherwise.} \end{cases}$$

$$(ii) (E_{i+1}^* A_{i-1} E_2^*)_{zy} = \begin{cases} 1 & \text{if } \partial(x, y) = 2 \text{ and } z \in \mathcal{D}_{i-1}^{i+1}, \\ 0 & \text{otherwise.} \end{cases}$$

$$(iii) (E_i^* A_{i-1} E_1^* A E_2^*)_{zy} = \begin{cases} 2 & \text{if } \partial(x, y) = 2 \text{ and } z \in \mathcal{D}_{i-2}^i \cup \mathcal{D}_i^i(2), \\ 1 & \text{if } \partial(x, y) = 2 \text{ and } z \in \mathcal{D}_i^i(1), \\ 0 & \text{otherwise.} \end{cases}$$

$$(iv) (E_i^* A_{i+1} E_1^* A E_2^*)_{zy} = \begin{cases} 2 & \text{if } \partial(x, y) = 2 \text{ and } z \in \mathcal{D}_{i+2}^i \cup \mathcal{D}_i^i(0), \\ 1 & \text{if } \partial(x, y) = 2 \text{ and } z \in \mathcal{D}_i^i(1), \\ 0 & \text{otherwise.} \end{cases}$$

$$(v) (E_i^* A_i E_2^*)_{zy} = \begin{cases} 1 & \text{if } \partial(x, y) = 2 \text{ and } z \in \mathcal{D}_i^i, \\ 0 & \text{otherwise.} \end{cases}$$

$$(vi) \sum_{h=0}^2 B_h^i = E_i^* A_i E_2^* \text{ and } B_1^i + 2B_2^i = E_i^* A_{i-1} E_1^* A E_2^* - 2E_i^* A_{i-2} E_2^*.$$

$$(vii) 2B_0^i + B_1^i = E_i^* A_{i+1} E_1^* A E_2^* - 2E_i^* A_{i+2} E_2^*.$$

PROOF. Immediate from definition of sets  $\mathcal{D}_j^i$ ,  $\mathcal{D}_j^i(h)$  ( $0 \leq h \leq 2$ ), Lemma 5.20 and Lemma 5.21.  $\blacksquare$

With reference to Definition 8.23, in Section 5.6 we had defined matrices  $L = L(x)$  and  $R = R(x)$  in  $T$  as follows. The  $(y, z)$ -entry of  $L$  is 1 if  $y, z$  are adjacent with  $\partial(x, z) = \partial(x, y) + 1$  and 0 otherwise ( $y, z \in X$ ). The  $(y, z)$ -entry of  $R$  is 1 if  $y, z$  are adjacent with  $\partial(x, y) = \partial(x, z) + 1$  and 0 otherwise ( $y, z \in X$ ). Then  $L, R \in T$  since

$$L = \sum_{h=0}^D E_{h-1}^* A E_h^*, \quad R = \sum_{h=0}^D E_{h+1}^* A E_h^* \quad (8.1)$$

(for notational convenience, we let  $E_{-1}^* = E_{D+1}^* = 0$ ). It is not hard to see that if  $\Gamma$  is bipartite, then  $R + L = A$ . We refer to  $R$  and  $L$  as the *raising* and *lowering* matrix with respect to  $x$ , respectively.

**Lemma 8.26** *With reference to Definition 8.24, let  $y \in \Gamma_2(x)$ . Then the following (i), (ii) hold.*

(i) *For  $2 \leq i \leq D$ , if  $\Delta_{i-1} \neq 0$  then*

$$\begin{aligned} L E_i^* A_{i-2} E_2^* &= (c_{i-1} - \alpha_{i-1}) E_{i-1}^* A_{i-1} E_2^* + (2\beta_{i-1} + b_{i-1}) E_{i-1}^* A_{i-3} E_2^* \\ &\quad - \beta_{i-1} E_{i-1}^* A_{i-2} E_1^* A E_2^*. \end{aligned}$$

(ii) *For  $3 \leq i \leq D - 3$ , if  $\Delta_{i+1} \neq 0$  then*

$$\begin{aligned} R E_i^* A_{i+2} E_2^* &= (c_{i+1} - \alpha_{i+1} - 2\beta_{i+1}) E_{i+1}^* A_{i+1} E_2^* + (c_{i+1} - 2\beta_{i+1}) E_{i+1}^* A_{i+3} E_2^* \\ &\quad + \beta_{i+1} E_{i+1}^* A_{i+2} E_1^* A E_2^*. \end{aligned}$$

PROOF. By Remark 8.19, for every  $i$  ( $2 \leq i \leq D - 1$ ) there exist complex scalars  $\alpha_i, \beta_i$  such that  $H_i = \alpha_i I_i + \beta_i G_i$ . We will prove claim (i). The proof of (ii) is similar.

(i) Choose  $z, y \in X$  and integer  $i$  ( $2 \leq i \leq D$ ). Note that by (8.1),  $L E_i^* A_{i-2} E_2^* = E_{i-1}^* A E_i^* A_{i-2} E_2^*$ . It follows from Lemmas 5.20, 5.21 that the  $(z, y)$ -entries of both sides of the equation are 0 if  $\partial(x, y) \neq 2$  or  $\partial(x, z) \neq i - 1$ .

Assume now  $\partial(x, y) = 2$  and  $\partial(x, z) = i - 1$ . Observe that by Lemma 5.21, the number  $(L E_i^* A_{i-2} E_2^*)_{zy}$  is equal to the number of neighbours that  $z$  has in  $\mathcal{D}_{i-2}^i$ . Assume that  $\Delta_{i-1} \neq 0$ .

Since for every  $0 \leq h \leq 2$  each  $z \in \mathcal{D}_{i-1}^{i-1}(h)$  is adjacent to precisely  $c_{i-1} - (\alpha_{i-1} + h\beta_{i-1})$  vertices in  $\mathcal{D}_{i-2}^i$  and each  $z \in \mathcal{D}_{i-3}^{i-1}$  is adjacent to precisely  $b_{i-1}$  vertices in  $\mathcal{D}_{i-2}^i$ , we have

$$LE_i^* A_{i-2} E_2^* = \sum_{h=0}^2 (c_{i-1} - \alpha_{i-1} - h\beta_{i-1}) B_h^{i-1} + b_{i-1} E_{i-1}^* A_{i-3} E_2^*.$$

The result follows from Lemma 8.25(vi). ■

**Lemma 8.27** *With reference to Definition 8.24, let  $y \in \Gamma_2(x)$ . Then the following (i)–(iv) hold.*

- (i) For  $0 \leq i \leq D - 2$ ,  $LE_i^* A_{i+2} E_2^* = b_{i+1} E_{i-1}^* A_{i+1} E_2^*$ .
- (ii) For  $3 \leq i \leq f$ ,  $LE_i^* A_{i-2} E_2^* = E_{i-1}^* A_{i-1} E_2^* + b_{i-1} E_{i-1}^* A_{i-3} E_2^*$ .
- (iii) For  $2 \leq i \leq D$ ,  $RE_i^* A_{i-2} E_2^* = c_{i-1} E_{i+1}^* A_{i-1} E_2^*$ .
- (iv) For  $\ell \leq i \leq D - 3$ ,  $RE_i^* A_{i+2} E_2^* = E_{i+1}^* A_{i+1} E_2^* + c_{i+1} E_{i+1}^* A_{i+3} E_2^*$ .

PROOF. Similar to the proof of Lemma 8.26. ■

## 8.5 More products in $T$

In this section, using our equitable partition from Section 8.3, we evaluate more products in the Terwilliger algebra which we shall need later.

**Lemma 8.28** *With reference to Definition 8.18, for  $y, z \in \Gamma_2(x)$  and  $2 \leq i \leq D$  the number  $|\Gamma_{i-2}(z) \cap \mathcal{D}_{i-2}^i|$  is equal to  $k_i c_i c_{i-1} k^{-1} (k-1)^{-1}$  if  $y = z$ ,  $k_i c_i c_{i-1} (c_{i-1} - 1) k^{-1} (k-1)^{-1} (k-2)^{-1}$  if  $\partial(y, z) = 2$ , and  $k_i c_i c_{i-1} (c_{i-1} (c_i - 4) + 2) k^{-1} (k-1)^{-1} (k-2)^{-1} (k-3)^{-1}$  if  $\partial(y, z) = 4$ .*

PROOF. If  $y = z$ , then  $|\Gamma_{i-2}(z) \cap \mathcal{D}_{i-2}^i|$  is equal to  $p_{i,i-2}^2$ , and the result now follows from Lemma 3.7(i). Assume  $\partial(y, z) = 2$  and note that  $z \in \mathcal{D}_2^2$ . It follows from Theorem 8.22 that the number of paths of length  $i - 2$  between  $z$  and  $\mathcal{D}_{i-2}^i$  is independent of  $z$ . Moreover, between any two vertices of  $\Gamma$  which are at distance  $i - 2$ , there exist exactly  $c_1 c_2 \cdots c_{i-2}$  paths of length  $i - 2$ . Therefore, the scalar  $|\Gamma_{i-2}(z) \cap \mathcal{D}_{i-2}^i|$  is independent of  $z$ ; denote this scalar by  $\psi_i$ . Pick  $w \in \mathcal{D}_1^1 = \{\bar{x}, \bar{y}\}$  and note that  $\mathcal{D}_2^2(1) = \mathcal{D}_2^2$ , and for  $v \in \mathcal{D}_{i-2}^i$  we have  $\partial(v, w) = i - 1$ . Thus for any  $v \in \mathcal{D}_{i-2}^i$ , there are precisely  $c_{i-1} - 1$  vertices in  $\mathcal{D}_2^2$  that are adjacent to  $w$  and distance  $i - 2$  from  $v$ . Using these comments we count in two ways the number of pairs  $(z, v)$  such that  $z \in \mathcal{D}_2^2$ ,  $v \in \mathcal{D}_{i-2}^i$ , and  $\partial(z, v) = i - 2$ . This yields  $\psi_i |\mathcal{D}_2^2| = |\mathcal{D}_{i-2}^i| 2(c_{i-1} - 1)$ . Thus  $\psi_i = p_{i,i-2}^2 2(c_{i-1} - 1) (p_{2,2}^2)^{-1}$ . Using Lemma 3.7 and the fact that  $c_2 = 2$ ,  $c_3 = 3$ , we find  $\psi_i = k_i c_i c_{i-1} (c_{i-1} - 1) k^{-1} (k-1)^{-1} (k-2)^{-1}$ .

Now assume  $\partial(y, z) = 4$ , and use a similar argument. Again let  $\psi_i = |\Gamma_{i-2}(z) \cap \mathcal{D}_{i-2}^i|$ . Note that for any  $v \in \mathcal{D}_{i-2}^i$ , there are precisely  $2(c_{i-1} - 1)$  vertices in  $\mathcal{D}_2^2$  that are distance  $i - 2$  from  $v$ , as we counted above. Hence there are precisely  $p_{2,i-2}^i - 1 - 2(c_{i-1} - 1)$  vertices in  $\mathcal{D}_4^2$  that are distance  $i - 2$  from  $v$ . Here we count in two ways the number of pairs  $(z, v)$  such that  $z \in \mathcal{D}_4^2$ ,  $v \in \mathcal{D}_{i-2}^i$ , and  $\partial(z, v) = i - 2$ . This yields  $\psi_i |\mathcal{D}_4^2| = |\mathcal{D}_{i-2}^i| (p_{2,i-2}^i - 1 - 2(c_{i-1} - 1))$ . Using Lemma 3.7 and the fact that  $c_2 = 2$ ,  $c_3 = 3$ , we obtain the desired result. ■

**Corollary 8.29** *With reference to Definition 8.18, write  $E_i^* = E_i^*(x)$  ( $0 \leq i \leq D$ ). Then for  $2 \leq i \leq D$  we have*

$$\begin{aligned} E_2^* A_{i-2} E_i^* A_{i-2} E_2^* &= \frac{k_i c_i c_{i-1}}{k(k-1)} E_2^* + \frac{k_i c_i c_{i-1} (c_{i-1} - 1)}{k(k-1)(k-2)} E_2^* A_2 E_2^* \\ &\quad + \frac{k_i c_i c_{i-1} (c_{i-1} (c_i - 4) + 2)}{k(k-1)(k-2)(k-3)} E_2^* A_4 E_2^*. \end{aligned}$$

PROOF. For  $y, z \in X$ , one verifies the  $(y, z)$ -entry of both sides are equal. If  $y \notin \Gamma_2(x)$  or  $z \notin \Gamma_2(x)$ , then the  $(y, z)$ -entry of each side is 0. If  $y, z \in \Gamma_2(x)$  then the  $(y, z)$ -entry of both sides are equal by Lemmas 5.20, 5.21 and 8.28. ■

**Lemma 8.30** *With reference to Definition 8.18, for  $y, z \in \Gamma_2(x)$  and  $2 \leq i \leq D - 2$  the number  $|\Gamma_{i-2}(z) \cap \mathcal{D}_{i+2}^i|$  is equal to  $k_i b_i b_{i+1} c_i c_{i-1} k^{-1} (k-1)^{-1} (k-2)^{-1} (k-3)^{-1}$  if  $\partial(y, z) = 4$ , and 0 otherwise.*

PROOF. Similar to the proof of Lemma 7.23, using the facts that  $c_2 = 2, c_3 = 3$ . ■

**Corollary 8.31** *With reference to Definition 8.18, write  $E_i^* = E_i^*(x)$  ( $0 \leq i \leq D$ ). Then for  $2 \leq i \leq D - 2$  we have*

$$E_2^* A_{i+2} E_i^* A_{i-2} E_2^* = \frac{k_i b_i b_{i+1} c_i c_{i-1}}{k(k-1)(k-2)(k-3)} E_2^* A_4 E_2^*.$$

PROOF. Similar to the proof of Corollary 8.29. ■

**Lemma 8.32** *With reference to Definition 8.18, for  $y, z \in \Gamma_2(x)$  and  $2 \leq i \leq D - 2$  the number  $|\Gamma_i(z) \cap \mathcal{D}_{i+2}^i|$  is equal to 0 if  $y = z$ ,  $k_i b_i b_{i+1} (c_{i+1} - 1) k^{-1} (k-1)^{-1} (k-2)^{-1}$  if  $\partial(y, z) = 2$ , and  $k_i b_i b_{i+1} (c_i (b_{i-1} - 1) + (b_i - 4)(c_{i+1} - 1)) k^{-1} (k-1)^{-1} (k-2)^{-1} (k-3)^{-1}$  if  $\partial(y, z) = 4$ .*

PROOF. Similar to the proof of Lemma 7.25 using the facts that  $c_2 = 2, c_3 = 3$ . ■

**Corollary 8.33** *With reference to Definition 8.18, write  $E_i^* = E_i^*(x)$  ( $0 \leq i \leq D$ ). Then for  $2 \leq i \leq D - 2$  we have*

$$\begin{aligned} E_2^* A_{i+2} E_i^* A_i E_2^* &= \frac{k_i b_i b_{i+1} (c_{i+1} - 1)}{k(k-1)(k-2)} E_2^* A_2 E_2^* \\ &+ \frac{k_i b_i b_{i+1} (c_i (b_{i-1} - 1) + (b_i - 4)(c_{i+1} - 1))}{k(k-1)(k-2)(k-3)} E_2^* A_4 E_2^*. \end{aligned}$$

PROOF. Similar to the proof of Corollary 8.29. ■

## 8.6 Some scalar products

In the remainder of the chapter, we will use the following definition.

**Definition 8.34** *With reference to Definitions 8.18 and 8.23, let  $W$  denote an irreducible  $T$ -module with endpoint 2, and let  $v$  denote a nonzero vector in  $E_2^* W$ . For  $0 \leq i \leq D$ , define*

$$v_i^+ = E_i^* A_{i-2} v, \quad v_i^- = E_i^* A_{i+2} v. \quad (8.2)$$

Observe that  $v_2^+ = v, v_i^+ = 0$  if  $i < 2$ , and  $v_i^- = 0$  if  $i < 2$  or  $i > D - 2$ . Moreover, by [10, Corollary 9.3(i)], we have

$$E_i^* A_i E_2^* v = -(v_i^+ + v_i^-) \quad (0 \leq i \leq D). \quad (8.3)$$

**Lemma 8.35** ([9, Corollary 5.9]) *With reference to Definition 8.34,  $JW = 0$ .*

**Lemma 8.36** *With reference to Definition 8.34,  $E_2^* A_2 E_2^* v = -2v$ .*

PROOF. Let  $\Gamma_2^2 = \Gamma_2^2(x)$  denote the graph with vertex set  $\tilde{X} = \Gamma_2(x)$  and edge set  $\tilde{R} = \{yz \mid y, z \in \tilde{X}, \partial(y, z) = 2\}$ . The graph  $\Gamma_2^2$  has exactly  $k_2$  vertices and it is regular with valency  $p_{22}^2$  ([11, Lemma 3.2]). Let  $\tilde{A}$  denote the adjacency matrix of  $\Gamma_2^2$ . The matrix  $\tilde{A}$  is symmetric with real entries. Therefore,  $\tilde{A}$  is diagonalizable with all eigenvalues real. Note that eigenvalues for  $E_2^*A_2E_2^*$  and  $\tilde{A}$  are the same.

Since  $\Delta_2 = 0$ , we know  $E_2^*A_2E_2^*$  has exactly one distinct eigenvalue, say  $\eta$ , on  $E_2^*W$  by [11, Theorem 4.11, Corollary 4.13, Lemma 5.3]. Thus, every nonzero vector in  $E_2^*W$  is an eigenvector for  $E_2^*A_2E_2^*$  with eigenvalue  $\eta$ . By [11, Lemmas 5.4, 5.5] and the fact that  $c_2 = 2$ , we find  $\eta = -2$ . The result follows.  $\blacksquare$

**Lemma 8.37** *With reference to Definition 8.34,  $E_2^*A_4E_2^*v = v$ .*

PROOF. By Lemma 8.35, Lemma 5.20 and the fact that  $J = \sum_{i=0}^D A_i$ , we find

$$0 = E_2^*Jv = E_2^*v + E_2^*A_2E_2^*v + E_2^*A_4E_2^*v.$$

The result now follows from Lemma 8.36.  $\blacksquare$

**Lemma 8.38** *With reference to Definition 8.34, the following (i)–(iii) hold.*

- (i)  $\|v_i^+\|^2 = \frac{k_i c_i c_{i-1} ((k-2)(b_{i-1} - 1) - c_{i-1} b_i)}{k(k-1)(k-2)(k-3)} \|v\|^2 \quad (2 \leq i \leq D).$
- (ii)  $\|v_i^-\|^2 = \frac{k_i b_i b_{i+1} ((k-2)(c_{i+1} - 1) - c_i b_{i+1})}{k(k-1)(k-2)(k-3)} \|v\|^2 \quad (2 \leq i \leq D-2).$
- (iii)  $\langle v_i^+, v_i^- \rangle = \frac{k_i b_i b_{i+1} c_i c_{i-1}}{k(k-1)(k-2)(k-3)} \|v\|^2 \quad (2 \leq i \leq D-2).$

PROOF. (i) Evaluating  $\|v_i^+\|^2 = \langle E_i^*A_{i-2}v, E_i^*A_{i-2}v \rangle$  using  $v = E_2^*v$ , (3.6), and Corollary 8.29, we find

$$\begin{aligned} \|v_i^+\|^2 &= \frac{k_i c_i c_{i-1}}{k(k-1)} \|v\|^2 + \frac{k_i c_i c_{i-1} (c_{i-1} - 1)}{k(k-1)(k-2)} \langle E_2^*A_2E_2^*v, v \rangle \\ &\quad + \frac{k_i c_i c_{i-1} (c_{i-1} (c_i - 4) + 2)}{k(k-1)(k-2)(k-3)} \langle E_2^*A_4E_2^*v, v \rangle. \end{aligned}$$

The result now follows from Lemmas 8.36 and 8.37.

(ii) Using (8.3), we observe  $\|v_i^-\|^2 = \langle E_i^*A_{i+2}v, E_i^*A_{i+2}v \rangle = \langle -E_i^*A_{i-2}v - E_i^*A_i v, E_i^*A_{i+2}v \rangle$ . The rest of the proof is now similar to the proof of (i) above.

(iii) Similar to the proof of (i) above.  $\blacksquare$

**Lemma 8.39** *With reference to Definition 8.34, the following (i)–(ii) hold.*

- (i) *For every  $i$  ( $f \leq i \leq \ell$ ),  $\{v_i^+, v_i^-\}$  is linearly independent set.*
- (ii) *For every  $i$  ( $2 \leq i \leq f-1$ ) (and if  $\ell \leq D-2$  for  $\ell+1 \leq i \leq D-2$ ),  $\{v_i^+, v_i^-\}$  is a linearly dependent set.*

PROOF. Note that

$$\begin{aligned} &\frac{k^2(k-1)^2(k-2)^2(k-3)^2}{k_i^2 b_i b_{i+1} c_i c_{i-1} \|v\|^4} \begin{vmatrix} \langle v_i^+, v_i^+ \rangle & \langle v_i^+, v_i^- \rangle \\ \langle v_i^-, v_i^+ \rangle & \langle v_i^-, v_i^- \rangle \end{vmatrix} \\ &= \begin{vmatrix} (k-2)(b_{i-1} - 1) - c_{i-1} b_i & b_i b_{i+1} \\ c_i c_{i-1} & (k-2)(c_{i+1} - 1) - c_i b_{i+1} \end{vmatrix} \end{aligned}$$



$$= (k-1)(k-2)(c_{i+1}(c_i - c_{i-1} - 1) + b_{i-1}(c_{i+1} - c_i - 1) + c_{i-1} - c_{i+1} + 2).$$

Now, the result follows immediately from Lemma 6.8(ii) and Lemma 8.13 (for example, for every  $i$  ( $f \leq i \leq \ell$ ), the above expression is nonzero). ■

**Corollary 8.40** *With reference to Definition 8.34, for every  $i$  ( $2 \leq i \leq f-1$ ) (and if  $\ell \leq D-2$ , for  $\ell+1 \leq i \leq D-2$ ),  $v_i^+ = v_i^-$ .*

PROOF. Note that, since  $\{v_i^+, v_i^-\}$  is a linearly dependent set, we have  $v_i^- = \frac{\langle v_i^+, v_i^- \rangle}{\|v_i^+\|^2} v_i^+$  (Lemma 6.10(i) and Lemma 8.38(i) yield  $\|v_i^+\| \neq 0$ ). By Lemma 8.13(i), (ii) and Lemma 8.38,  $\frac{\langle v_i^+, v_i^- \rangle}{\|v_i^+\|^2} = 1$ . The result follows. ■

## 8.7 The irreducible $T$ -modules with endpoint 2

With reference to Definition 8.34, in this section we describe the irreducible  $T$ -modules with endpoint 2.

**Lemma 8.41** *With reference to Definition 8.34, assume  $\ell \leq D-2$ . Then the following (i), (ii) hold.*

- (i) For  $2 \leq i \leq D$ ,  $v_i^+ \neq 0$  if and only if  $2 \leq i \leq D-2$ .
- (ii) For  $2 \leq i \leq D-2$ ,  $v_i^- \neq 0$ .

PROOF. Note that  $\ell \leq D-2$  yields  $c_{D-2} = k-2$  by Lemma 8.13(ii). Since  $c_{D-2} = k-2$  if and only if  $(k-2)(b_{D-2} - 1) - c_{D-2}b_{D-1} = 0$ , Lemma 8.38 yields  $\|v_{D-1}^+\| = 0$ , which implies  $v_{D-1}^+ = 0$ . Next,  $c_{D-2} = k-2$  yields  $b_{D-2} = 2$ ,  $b_{D-1} = 1$  and with that  $\|v_D^+\| = 0$ . Thus  $v_D^+ = 0$ .

The rest of the proof follows immediately from Lemmas 6.10 and 8.38. ■

**Lemma 8.42** *With reference to Definition 8.34, assume  $\ell = D-1$ . Then the following (i), (ii) hold.*

- (i) For  $2 \leq i \leq D$ ,  $v_i^+ \neq 0$  if and only if  $2 \leq i \leq D-1$ .
- (ii) For  $2 \leq i \leq D-2$ ,  $v_i^- \neq 0$ .

PROOF. Immediate from Lemmas 6.7, 6.10, 8.13 and 8.38. ■

**Theorem 8.43** *With reference to Definition 8.34, the following is a basis for  $W$ :*

$$v_i^+ \quad (2 \leq i \leq \ell), \quad v_i^- \quad (f \leq i \leq D-2). \quad (8.4)$$

PROOF. We first show that  $W$  is spanned by the vectors (8.4). Let  $W'$  denote the subspace of  $V$  spanned by the vectors (8.4) and note that  $W' \subseteq W$ . We claim that  $W'$  is a  $T$ -module. By construction  $W'$  is  $M^*$ -invariant. First we observe  $E_1^* A E_2^* v = 0$  since  $W$  has endpoint 2. It now follows from (8.3), Lemmas 8.26, 8.27, 8.36 and Corollary 8.40 that  $W'$  is invariant under  $L$  and  $R$ . Recall that  $A = L + R$  and  $A$  generates  $M$  so  $W'$  is  $M$ -invariant. The claim follows. Note that  $W' \neq 0$  since  $v \in W'$  so  $W' = W$  by the irreducibility of  $W$ .

Moreover, the vectors (8.4) are nonzero by Lemma 8.41, and linearly independent by (5.5) and Lemma 8.39. The result follows. ■



## 8.8 The irreducible $T$ -modules with endpoint 2: the $A$ -action

With reference to Definition 8.34, in this section, we display the action of  $A$  on the basis for  $W$  given in Theorem 8.43. Since  $A = L + R$ , it suffices to give the actions of  $L, R$  on this basis.

**Lemma 8.44** *With reference to Definition 8.34, for all nonzero  $v \in E_2^*W$  the following (i)–(iv) hold.*

- (i)  $Lv_2^+ = 0$ .
- (ii)  $Lv_i^+ = (b_{i-1} - 2)v_{i-1}^+ \quad (3 \leq i \leq f)$ .
- (iii)  $Lv_i^+ = \frac{b_{i-1}(k-2)(c_i - c_{i-1} - 1)}{2\Delta_{i-1}}v_{i-1}^+ + c_{i-1} \left( \frac{(k-2)(c_{i-1} - c_{i-2} - 1)}{2\Delta_{i-1}} - 1 \right) v_{i-1}^- \quad (f+1 \leq i \leq \ell)$ .
- (iv)  $Lv_i^- = b_{i+1}v_{i-1}^- \quad (f \leq i \leq D-2)$ .

PROOF. First observe that  $E_1^*AE_2^*v = 0$ , since  $W$  has endpoint 2. Applying the equations in Lemmas 8.26(i), 8.27 to  $v$ , and using (8.3), Theorem 8.16 and Corollary 8.40, we obtain the desired result (note that by Corollary 8.40,  $v_{f-1}^- = v_{f-1}^+$ ).  $\blacksquare$

**Lemma 8.45** *With reference to Definition 8.34, assume  $\ell \leq D-2$ . Then for all nonzero  $v \in E_2^*W$  the following (i)–(iv) hold.*

- (i)  $Rv_i^+ = c_{i-1}v_{i+1}^+ \quad (2 \leq i \leq \ell)$ .
- (ii) For  $f \leq i \leq \ell-1$ 

$$Rv_i^- = c_{i+1} \left( \frac{(k-2)(c_{i+1} - c_i - 1)}{2\Delta_{i+1}} - 1 \right) v_{i+1}^+ + \left( c_{i+1} - b_{i+1} + \frac{b_{i+1}(k-2)(c_{i+2} - c_{i+1} - 1)}{2\Delta_{i+1}} \right) v_{i+1}^-.$$
- (iii)  $Rv_i^- = (c_{i+1} - 2)v_{i+1}^- \quad (\ell \leq i \leq D-3)$ .
- (iv)  $Rv_{D-2}^- = 0$ .

PROOF. First observe that  $E_1^*AE_2^*v = 0$ , since  $W$  has endpoint 2. Applying the equations in Lemma 8.26(ii), 8.27 to  $v$ , and using (8.3), Theorem 8.16 and Corollary 8.40, we obtain the desired result.  $\blacksquare$

**Lemma 8.46** *With reference to Definition 8.34, assume  $\ell = D-1$ . Then for all nonzero  $v \in E_2^*W$  the following (i)–(iii) hold.*

- (i)  $Rv_i^+ = c_{i-1}v_{i+1}^+ \quad (2 \leq i \leq D-2)$ .
- (ii)  $Rv_{D-1}^+ = 0$ .
- (iii) For  $f \leq i \leq D-2$ 

$$Rv_i^- = c_{i+1} \left( \frac{(k-2)(c_{i+1} - c_i - 1)}{2\Delta_{i+1}} - 1 \right) v_{i+1}^+ + \left( c_{i+1} - b_{i+1} + \frac{b_{i+1}(k-2)(c_{i+2} - c_{i+1} - 1)}{2\Delta_{i+1}} \right) v_{i+1}^-.$$

PROOF. Similar to the proof of Lemma 8.45.  $\blacksquare$

## 8.9 The isomorphism class

In this section we prove that up to isomorphism there exists exactly one irreducible  $T$ -module with endpoint 2.

**Theorem 8.47** *With reference to Definition 8.18, let  $T = T(x)$  denote Terwilliger algebra with respect to  $x$ . Then the following (i), (ii) hold.*

- (i) *Up to isomorphism, there is a unique irreducible  $T$ -module of endpoint 2.*
- (ii) *Let  $W$  denote an irreducible  $T$ -module with endpoint 2. Then  $W$  appears in  $V$  with multiplicity  $k_2 - k$ .*

**PROOF.** Since  $x \in X$  is fixed, we will suppress it in notation, writing  $E_i^* = E_i^*(x)$  ( $0 \leq i \leq D$ ) and  $M^* = M^*(x)$  for the dual idempotents with respect to  $x$  and the dual Bose-Mesner algebra with respect to  $x$ , respectively.

(i) First assume  $\ell \leq D - 2$ . Let  $W$  and  $W'$  denote irreducible  $T$ -modules with endpoint 2. Fix nonzero  $v \in E_2^*W$ ,  $v' \in E_2^*W'$ . By Theorem 8.43,  $W$  has basis  $\{E_i^*A_{i-2}v \mid 2 \leq i \leq \ell\} \cup \{E_i^*A_{i+2}v \mid f \leq i \leq D - 2\}$ , and  $W'$  has a basis  $\{E_i^*A_{i-2}v' \mid 2 \leq i \leq \ell\} \cup \{E_i^*A_{i+2}v' \mid f \leq i \leq D - 2\}$ . Let  $\sigma : W \rightarrow W'$  denote the vector space isomorphism defined by  $\sigma(E_i^*A_{i-2}v) = E_i^*A_{i-2}v'$  ( $2 \leq i \leq \ell$ ) and  $\sigma(E_i^*A_{i+2}v) = E_i^*A_{i+2}v'$  ( $f \leq i \leq D - 2$ ). We show that  $\sigma$  is a  $T$ -module isomorphism. Since  $A$  generates  $M$  and  $E_0^*, E_1^*, \dots, E_D^*$  is a basis for  $M^*$ , it suffices to show  $\sigma$  commutes with each of  $A, E_0^*, E_1^*, \dots, E_D^*$ .

Using (eiv) and the definition of  $\sigma$ , we immediately find that  $\sigma$  commutes with each of  $E_0^*, E_1^*, \dots, E_D^*$ . It follows from Lemmas 8.44, 8.45 that  $\sigma$  commutes with each of  $L, R$ . Recall  $A = L + R$ , so  $\sigma$  commutes with  $A$ . The result follows.

The case when  $\ell = D - 1$  is considered in a similar way.

(ii) Routine. ■

# On the Terwilliger algebra of a bipartite DRG with $D \leq 5$

Let  $\Gamma = (X, \mathcal{R})$  denote a bipartite distance-regular graph with diameter  $D \geq 4$  and valency  $k \geq 3$ . Assume  $\Gamma$  is not almost 2-homogeneous. We fix  $x \in X$  and let  $E_i^* = E_i^*(x)$  ( $0 \leq i \leq D$ ) and  $T = T(x)$  denote the dual idempotents and the Terwilliger algebra of  $\Gamma$  with respect to  $x$ , respectively. Let  $W$  denote an irreducible  $T$ -module with endpoint 2 and let  $v$  denote a nonzero vector in  $E_2^*W$ . For  $0 \leq i \leq D$ , define  $v_i^+ = E_i^*A_{i-2}E_2^*v$ ,  $v_i^- = E_i^*A_{i+2}E_2^*v$ .

Main results of this section are Theorems 9.10 and 9.24.

In Theorem 9.10 we find a spanning set for  $W$ , that is,

$$W = \text{span}\{v_2^+, v_3^+, \dots, v_D^+, v_2^-, v_3^-, \dots, v_{D-2}^-\}$$

under assumption that there exist complex scalars  $\alpha_i, \beta_i$  ( $2 \leq i \leq D-1$ ) such that  $|\Gamma_{i-1}(x) \cap \Gamma_{i-1}(y) \cap \Gamma_1(z)| = \alpha_i + \beta_i |\Gamma_1(x) \cap \Gamma_1(y) \cap \Gamma_{i-1}(z)|$  holds for all  $y \in \Gamma_2(x)$  and  $z \in \Gamma_i(x) \cap \Gamma_i(y)$ .

In Theorem 9.24 we prove that the following (i), (ii) are equivalent.

- (i)  $\Gamma$  has, up to isomorphism, exactly one irreducible  $T$ -module  $W$  with endpoint 2, and  $W$  is non-thin with  $\dim(E_2^*W) = 1$ ,  $\dim(E_{D-1}^*W) \leq 1$  and  $\dim(E_i^*W) \leq 2$  for  $3 \leq i \leq D$ .
- (ii)  $\Delta_2 = 0$ , and there exist complex scalars  $\alpha_i, \beta_i$  ( $2 \leq i \leq D-1$ ) such that

$$|\Gamma_{i-1}(x) \cap \Gamma_{i-1}(y) \cap \Gamma_1(z)| = \alpha_i + \beta_i |\Gamma_1(x) \cap \Gamma_1(y) \cap \Gamma_{i-1}(z)|$$

for all  $y \in \Gamma_2(x)$  and  $z \in \Gamma_i(x) \cap \Gamma_i(y)$ .

This chapter presents joint work with Š. Miklavič, and the paper is accepted for publication in the journal “The Art of Discrete and Applied Mathematics” (see [37]).

## 9.1 Background

Let us introduce some notation that we will use in the rest of this section.

**Definition 9.1** ([12, Definition 3.2]) Let  $\Gamma$  denote a distance-regular with diameter  $D \geq 4$  and valency  $k \geq 3$ . Fix  $x \in X$ . For  $1 \leq i \leq D$  we define matrices  $\Lambda_i = \Lambda_i(x)$  in  $\text{Mat}_X(\mathbb{C})$  by

$$(\Lambda_i)_{zy} = \begin{cases} |\Gamma_1(x) \cap \Gamma_1(y) \cap \Gamma_{i-1}(z)|, & \text{if } \partial(x, y) = 2, \partial(x, z) = \partial(y, z) = i, \\ 0, & \text{otherwise} \end{cases} \quad (z, y \in X).$$

**Notation 9.2** Let  $\Gamma = (X, \mathcal{R})$  denote a bipartite distance-regular graph with diameter  $D \geq 4$ , valency  $k \geq 3$  and intersection numbers  $b_i, c_i$ , which is not almost 2-homogeneous. Let  $A_i$  ( $0 \leq i \leq D$ ) be the distance matrices of  $\Gamma$ , and let  $V$  denote the standard module for  $\Gamma$ . We

fix  $x \in X$  and let  $E_i^* = E_i^*(x)$  ( $0 \leq i \leq D$ ) and  $T = T(x)$  denote the dual idempotents and the Terwilliger algebra of  $\Gamma$  with respect to  $x$ , respectively. We assume that for  $2 \leq i \leq D-1$ , there exist complex scalars  $\alpha_i, \beta_i$  such that for all  $y, z \in X$  with  $\partial(x, y) = 2, \partial(x, z) = i, \partial(y, z) = i$ , we have

$$\alpha_i + \beta_i |\Gamma_1(x) \cap \Gamma_1(y) \cap \Gamma_{i-1}(z)| = |\Gamma_{i-1}(x) \cap \Gamma_{i-1}(y) \cap \Gamma_1(z)|.$$

Let matrices  $L = L(x), R = R(x)$  and  $\Lambda_i = \Lambda_i(x)$  ( $1 \leq i \leq D$ ) be as in Definitions 5.19 and 9.1. Let scalars  $\Delta_i, \gamma_i$  ( $2 \leq i \leq D-1$ ) be as in Definition 6.1.

With reference to Notation 9.2, pick  $2 \leq i \leq D-1$  and assume that  $\Delta_i \neq 0$ . By Theorem 7.5 scalars  $\alpha_i$  and  $\beta_i$  are uniquely determined and given by

$$\begin{aligned} \alpha_i &= \frac{c_i(c_i - 1)(b_{i-1} - c_2) - c_i c_{i-1}(b_i - 1)(c_2 - 1)}{c_2 \Delta_i}, \\ \beta_i &= \frac{c_i(c_{i+1} - c_i)(b_{i-1} - 1) - b_i(c_{i+1} - 1)(c_i - c_{i-1})}{c_2 \Delta_i}. \end{aligned} \quad (9.1)$$

If  $\Delta_i = 0$ , then scalars  $\alpha_i$  and  $\beta_i$  are not uniquely determined. For example, if  $\Delta_2 = 0$ , then one of the possible values for  $\alpha_2$  and  $\beta_2$  is  $\alpha_2 = 0, \beta_2 = 1$ . Note however that by Lemma 6.3 this is not the only possible solution.

## 9.2 Some products in $T$

With reference to Notation 9.2, in this section we compute some products of matrices of  $T$ . We start by recalling the following results.

**Lemma 9.3** ([36, Lemma 6.1]) *With reference to Notation 9.2, for  $0 \leq h, i, j \leq D$  and  $y, z \in X$  the  $(y, z)$ -entry of  $E_h^* A_i E_j^*$  is 1 if  $\partial(x, y) = h, \partial(y, z) = i, \partial(x, z) = j$ , and 0 otherwise.*

**Lemma 9.4** ([36, Lemma 6.5]) *With reference to Notation 9.2, for  $0 \leq h, i, j, r, s \leq D$  and  $y, z \in X$  the  $(y, z)$ -entry of  $E_h^* A_r E_i^* A_s E_j^*$  is  $|\Gamma_i(x) \cap \Gamma_r(y) \cap \Gamma_s(z)|$  if  $\partial(x, y) = h, \partial(x, z) = j$ , and 0 otherwise.*

**Lemma 9.5** ([12, Lemma 3.3]) *With reference to Notation 9.2, we have*

$$\Lambda_1 = E_1^* A E_2^*, \quad \Lambda_i = E_i^* A_{i-1} E_1^* A E_2^* - c_2 E_i^* A_{i-2} E_2^* \quad (2 \leq i \leq D).$$

In particular,  $\Lambda_i \in T$  ( $1 \leq i \leq D$ ).

**Theorem 9.6** *With reference to Notation 9.2 the following holds for  $3 \leq i \leq D$ :*

$$L E_i^* A_{i-2} E_2^* = b_{i-1} E_{i-1}^* A_{i-3} E_2^* + (c_{i-1} - \alpha_{i-1}) E_{i-1}^* A_{i-1} E_2^* - \beta_{i-1} \Lambda_{i-1}. \quad (9.2)$$

PROOF. Pick  $z, y \in X$  and an integer  $3 \leq i \leq D$ . We show that  $(z, y)$ -entries of both sides of (9.2) agree. Note that by (5.3) and Lemma 9.4,

$$(L E_i^* A_{i-2} E_2^*)_{zy} = \begin{cases} |\Gamma_i(x) \cap \Gamma_{i-2}(y) \cap \Gamma_1(z)| & \text{if } \partial(x, y) = 2, \partial(x, z) = i-1, \\ 0 & \text{otherwise.} \end{cases} \quad (9.3)$$

It follows from (9.3), Lemma 9.3 and Definition 9.1 that the  $(z, y)$ -entries of both sides of (9.2) are 0 if  $\partial(x, y) \neq 2$  or  $\partial(x, z) \neq i-1$ . Assume now  $\partial(x, y) = 2$  and  $\partial(x, z) = i-1$ . Observe

that by the triangle inequality we have that  $\partial(z, y) \in \{i-3, i-1, i+1\}$ . We consider each of these three cases separately.

Case 1:  $\partial(x, y) = 2$ ,  $\partial(x, z) = i-1$  and  $\partial(z, y) = i-3$ . Note that in this case we have  $(LE_i^* A_{i-2} E_2^*)_{zy} = b_{i-1}$  by (9.3). By Lemma 9.3 and Definition 9.1 the  $(z, y)$ -entries of both sides of (9.2) agree.

Case 2:  $\partial(x, y) = 2$ ,  $\partial(x, z) = i-1$  and  $\partial(z, y) = i-1$ . Observe that by (9.3) we have

$$\begin{aligned} (LE_i^* A_{i-2} E_2^*)_{zy} &= c_{i-1} - |\Gamma_1(z) \cap \Gamma_{i-2}(x) \cap \Gamma_{i-2}(y)| \\ &= c_{i-1} - (\alpha_{i-1} + \beta_{i-1} |\Gamma_{i-2}(z) \cap \Gamma_1(x) \cap \Gamma_1(y)|). \end{aligned}$$

By Lemma 9.3 and Definition 9.1 the  $(z, y)$ -entries of both sides of (9.2) agree.

Case 3:  $\partial(x, y) = 2$ ,  $\partial(x, z) = i-1$  and  $\partial(z, y) = i+1$ . By (9.3), Lemma 9.3 and Definition 9.1 the  $(z, y)$ -entries of both sides of (9.2) are 0.  $\blacksquare$

### 9.3 Irreducible $T$ -modules with endpoint 2

With reference to Notation 9.2, let  $W$  denote an irreducible  $T$ -module with endpoint 2. In this section we find a spanning set for  $W$ .

**Definition 9.7** With reference to Notation 9.2, let  $W$  denote an irreducible  $T$ -module with endpoint 2 and let  $v$  denote a nonzero vector in  $E_2^* W$ . For  $0 \leq i \leq D$ , define

$$v_i^+ = E_i^* A_{i-2} E_2^* v, \quad v_i^- = E_i^* A_{i+2} E_2^* v.$$

Note that  $v_2^+ = v$ ,  $v_i^+ = 0$  if  $i < 2$ , and  $v_i^- = 0$  if  $i < 2$  or  $i > D-2$ .

**Lemma 9.8** ([10, Corollary 9.3(i), Theorem 9.4]) *With reference to Definition 9.7, the following (i)–(iv) hold.*

- (i)  $E_i^* A_i E_2^* v = -(v_i^+ + v_i^-)$  ( $2 \leq i \leq D$ ).
- (ii)  $Rv_i^+ = c_{i-1} v_{i+1}^+$  ( $2 \leq i \leq D-1$ ) and  $Rv_D^+ = 0$ .
- (iii)  $Lv_i^- = b_{i+1} v_{i-1}^-$  ( $2 \leq i \leq D-2$ ).
- (iv)  $Lv_{i+1}^+ - Rv_{i-1}^- = b_i v_i^+ - c_i v_i^-$  ( $1 \leq i \leq D-1$ ).

**Lemma 9.9** *With reference to Definition 9.7, the following (i)–(iii) hold.*

- (i)  $\Lambda_i v = -c_2 v_i^+$  ( $2 \leq i \leq D$ ).
- (ii)  $Lv_2^+ = 0$  and

$$Lv_i^+ = (b_{i-1} - c_{i-1} + \alpha_{i-1} + c_2 \beta_{i-1}) v_{i-1}^+ - (c_{i-1} - \alpha_{i-1}) v_{i-1}^-$$

for  $3 \leq i \leq D$ .

- (iii)

$$Rv_i^- = (c_2 \beta_{i+1} - c_{i+1} + \alpha_{i+1}) v_{i+1}^+ + \alpha_{i+1} v_{i+1}^-$$

for  $2 \leq i \leq D-2$ .

**PROOF.** (i) Immediate from Lemma 9.5 and Definition 9.7.

(ii) Note that  $Lv_2^+ = 0$  as the endpoint of  $W$  is 2. To obtain the result for  $Lv_i^+$  ( $3 \leq i \leq D$ ) apply (9.2) to  $v$  and use Definition 9.7, Lemma 9.8(i) and (i) above.

(iii) Immediately by (ii) above and Lemma 9.8(iv).  $\blacksquare$

**Theorem 9.10** *With reference to Definition 9.7,*

$$W = \text{span}\{v_2^+, v_3^+, \dots, v_D^+, v_2^-, v_3^-, \dots, v_{D-2}^-\}.$$

PROOF. Denote  $W' = \text{span}\{v_2^+, v_3^+, \dots, v_D^+, v_2^-, v_3^-, \dots, v_{D-2}^-\}$  and note that  $W' \subseteq W$ . We now show that  $W = W'$ . Note that  $E_i^* v_j^+ = \delta_{ij} v_j^+$  for  $2 \leq j \leq D$  and  $E_i^* v_j^- = \delta_{ij} v_j^-$  for  $2 \leq j \leq D-2$ . Therefore,  $W'$  is invariant under the action of  $E_i^*$  for  $0 \leq i \leq D$ . Observe also that  $W'$  is invariant under the action of  $L$  by Lemma 9.8(iii) and Lemma 9.9(ii), and also invariant under the action of  $R$  by Lemma 9.8(ii) and Lemma 9.9(iii). As  $A = R + L$ ,  $W'$  is invariant under the action of  $A$ . As  $T$  is generated by  $A$  and  $E_i^*$  ( $0 \leq i \leq D$ ), this implies that  $W'$  is a  $T$ -module. Recall that  $W$  is irreducible and that  $W'$  contains a nonzero vector  $v$ . It follows that  $W = W'$ .  $\blacksquare$

**Corollary 9.11** *With reference to Definition 9.7, we have*

$$\dim(E_{D-1}^* W) \leq 1, \quad \dim(E_D^* W) \leq 1.$$

PROOF. Immediately from Theorem 9.10.  $\blacksquare$

In the rest of the chapter we study the case when  $D = 5$  and  $\Delta_2 = 0$  in detail. If  $D = 5$  and  $\Delta_2 = \Delta_3 = 0$ , then  $\Gamma$  is almost 2-homogeneous, contradicting our assumption in Notation 9.2. Therefore, we have that  $\Delta_3 \neq 0$ .

## 9.4 The case $\Delta_2 = 0$ and $\Delta_3 \neq 0$

With reference to Notation 9.2, in this section we study graphs with  $\Delta_2 = 0$  and  $\Delta_3 \neq 0$ . We first have the following observation.

**Lemma 9.12** *With reference to Definition 9.7, assume that  $\Delta_2 = 0$  and  $\Delta_3 \neq 0$ . Then the following (i), (ii) hold.*

(i)

$$c_3 = \frac{(c_2^2 - c_2 + 1)k - c_2(c_2 + 1)}{k + c_2^2 - 3c_2}.$$

(ii)

$$\alpha_3 = 0, \quad \beta_3 = \frac{c_2(k-2)}{k + c_2^2 - 3c_2}.$$

PROOF. (i) Solve  $\Delta_2 = 0$  for  $c_3$ . Note that  $k + c_2^2 - 3c_2 = (c_2 - 1)(c_2 - 2) + k - 2 > 0$  as  $k \geq 3$ .

(ii) Use Definition 4.12, (9.1) and (i) above.  $\blacksquare$

**Lemma 9.13** *With reference to Definition 9.7, assume that  $\Delta_2 = 0$  and  $\Delta_3 \neq 0$ . Then*

$$E_2^* A_2 E_2^* v = -\frac{c_2(k-2)}{k + c_2^2 - 3c_2} v.$$

PROOF. Let  $\Gamma_2^2 = \Gamma_2^2(x)$  denote the graph with vertex set  $\tilde{X} = \Gamma_2(x)$  and edge set  $\tilde{R} = \{yz \mid y, z \in \tilde{X}, \partial(y, z) = 2\}$ . The graph  $\Gamma_2^2$  has exactly  $k_2$  vertices and it is regular with valency  $p_{22}^2$  ([11, Lemma 3.2]). Let  $\tilde{A}$  denote the adjacency matrix of  $\Gamma_2^2$ . The matrix  $\tilde{A}$  is symmetric with real entries. Therefore  $\tilde{A}$  is diagonalizable with all eigenvalues real. Note that eigenvalues for  $E_2^* A_2 E_2^*$  and  $\tilde{A}$  are the same.

Since  $\Delta_2 = 0$ , we know  $E_2^* A_2 E_2^*$  has exactly one distinct eigenvalue  $\eta$  on  $E_2^* W$  by [11, Theorem 4.11, Corollary 4.13, Lemma 5.3]. Thus, every nonzero vector in  $E_2^* W$  is an eigenvector for  $E_2^* A_2 E_2^*$  with eigenvalue  $\eta$ . By [11, Lemmas 5.4, 5.5] we find  $\eta = -\frac{c_2}{\gamma_2}$ . The result now follows from Definition 4.12 and Lemma 9.12(i).  $\blacksquare$

**Corollary 9.14** *With reference to Definition 9.7, assume that  $\Delta_2 = 0$  and  $\Delta_3 \neq 0$ . Then*

$$v_2^- = \frac{b_2(c_2 - 1)}{k + c_2^2 - 3c_2} v_2^+.$$

PROOF. By Lemma 9.8(i) and Lemma 9.13(i) we have

$$-v_2^+ - v_2^- = E_2^* A_2 E_2^* v = -\frac{c_2(k - 2)}{k + c_2^2 - 3c_2} v_2^+.$$

The result follows. ■

**Corollary 9.15** *With reference to Definition 9.7, assume that  $D = 5$ ,  $\Delta_2 = 0$  and  $\Delta_3 \neq 0$ . Then*

$$W = \text{span}\{v_2^+, v_3^+, v_4^+, v_5^+, v_3^-\}. \quad (9.4)$$

PROOF. Immediately from Theorem 9.10 and Corollary 9.14. ■

Observe that by (5.5) vectors  $v_2^+, v_3^+, v_4^+, v_5^+$  are linearly independent, provided they are non-zero.

## 9.5 Some scalar products

With reference to Definition 9.7, assume that  $D = 5$ ,  $\Delta_2 = 0$  and  $\Delta_3 \neq 0$ . Our goal for the rest of this chapter is to find a basis for  $W$ . In this section we compute the norms of vectors  $v_3^+, v_4^+, v_5^+, v_3^-$  in terms of the intersection numbers of  $\Gamma$  and  $\|v\|$ . Note that by [29, Lemma 6.4] we have  $\Delta_4 \neq 0$  as well. The assumptions of [29, Lemma 6.4] are somehow different from assumptions of Notation 9.2. However, the proof of [29, Lemma 6.4] works just fine also under assumptions of Notation 9.2.

**Lemma 9.16** *With reference to Definition 9.7, assume that  $\Delta_2 = 0$  and  $\Delta_3 \neq 0$ . Then*

$$\|v_3^+\|^2 = \frac{b_2(b_2 - c_2)}{k + c_2^2 - 3c_2} \|v\|^2.$$

*In particular, if  $D \geq 5$  then  $v_3^+ \neq 0$ .*

PROOF. By Lemma 9.8(ii), (2.1) and Definition 5.19 we have

$$\|v_3^+\|^2 = \langle v_3^+, v_3^+ \rangle = \langle Rv_2^+, v_3^+ \rangle = \langle v_2^+, Lv_3^+ \rangle.$$

The result now follows from Lemma 9.9(ii), Corollary 9.14 and since  $\alpha_2 = 0$ ,  $\beta_2 = 1$ . Now assume that  $v_3^+ = 0$ . Observe that this implies  $b_2 = c_2$ . If  $D \geq 5$  then by [3, Proposition 4.1.6](i),(ii) we have  $c_2 \leq c_3 \leq b_2$ , and so  $c_2 = c_3$ . But then  $c_2 = 1$  by Lemma 9.12(i), and so  $k = b_2 + c_2 = 2$ , a contradiction. ■

**Lemma 9.17** *With reference to Definition 9.7, assume that  $\Delta_2 = 0$  and  $\Delta_3 \neq 0$ . Then*

$$\langle v_3^+, v_3^- \rangle = \frac{b_2 b_4 (c_2 - 1)}{k + c_2^2 - 3c_2} \|v\|^2.$$

PROOF. By Lemma 9.8(ii), (2.1) and Definition 5.19 we have

$$\langle v_3^+, v_3^- \rangle = \langle Rv_2^+, v_3^- \rangle = \langle v_2^+, Lv_3^- \rangle.$$

The result now follows from Lemma 9.8(iii) and Corollary 9.14. ■

**Lemma 9.18** *With reference to Definition 9.7, assume that  $D = 5$ ,  $\Delta_2 = 0$  and  $\Delta_3 \neq 0$ . Then*

$$\|v_4^+\|^2 = \frac{b_2((b_3 - 1)b_2 - c_3(c_2 - 1)b_4)}{c_2(k + c_2^2 - 3c_2)} \|v\|^2.$$

*In particular,  $v_4^+ = 0$  if and only if  $c_2 \neq 1$  and  $b_4 = b_2(b_3 - 1)/(c_3(c_2 - 1))$ .*

PROOF. By Lemma 9.8(ii), (2.1) and Definition 5.19 we have

$$\langle v_4^+, v_4^+ \rangle = \frac{1}{c_2} \langle Rv_3^+, v_4^+ \rangle = \frac{1}{c_2} \langle v_3^+, Lv_4^+ \rangle.$$

The formula for  $\|v_4^+\|^2$  now follows from Lemma 9.9(ii), Lemma 9.12(ii), Lemma 9.16 and Lemma 9.17.

It is clear that  $v_4^+ = 0$  if  $c_2 \neq 1$  and  $b_4 = b_2(b_3 - 1)/(c_3(c_2 - 1))$ . Therefore assume now that  $v_4^+ = 0$ . It follows that  $(b_3 - 1)b_2 = c_3(c_2 - 1)b_4$ . If  $c_2 = 1$ , then also  $b_3 = 1$  and  $c_3 = 1$  by Lemma 9.12(i). But then  $k = c_3 + b_3 = 2$ , a contradiction. Therefore  $c_2 \neq 1$  and the result follows. ■

**Lemma 9.19** *With reference to Definition 9.7, assume that  $D = 5$ ,  $\Delta_2 = 0$  and  $\Delta_3 \neq 0$ . Then*

$$\|v_3^-\|^2 = \left( \frac{(c_2 - 1)(c_4 - 1)b_2}{k + c_2^2 - 3c_2} + \frac{(k - 1)\Delta_3}{b_2 - 1} \right) \frac{b_2 b_4 \|v\|^2}{c_2(kc_2 - k - c_2) + b_2}.$$

PROOF. By Lemma 9.8(iv), (2.1) and Definition 5.19 we have

$$c_3 \langle v_3^-, v_3^- \rangle = b_3 \langle v_3^+, v_3^- \rangle + \langle Rv_2^-, v_3^- \rangle - \langle v_4^+, Rv_3^- \rangle.$$

The result now follows from Lemmas 9.9(iii), 9.12, 9.17 and 9.18, Corollary 9.14 and (9.1). ■

**Corollary 9.20** *With reference to Definition 9.7, assume that  $D = 5$ ,  $\Delta_2 = 0$  and  $\Delta_3 \neq 0$ . Then the following (i), (ii) hold.*

(i)  $v_3^- \neq 0$ .

(ii)  $v_3^+, v_3^-$  are linearly independent.

PROOF. (i) Note that  $(c_2 - 1)(c_4 - 1)b_2/(k + c_2^2 - 3c_2) \geq 0$  and that  $(k - 1)\Delta_3/(b_2 - 1) > 0$  by [8, Theorem 12]. Moreover, it is easy to see that  $c_2(kc_2 - k - c_2) + b_2 > 0$ . The result follows.

(ii) Assume on the contrary that  $v_3^+, v_3^-$  are linearly dependent. Let

$$B = \begin{pmatrix} \langle v_3^+, v_3^+ \rangle & \langle v_3^+, v_3^- \rangle \\ \langle v_3^-, v_3^+ \rangle & \langle v_3^-, v_3^- \rangle \end{pmatrix}$$

and note that  $\det(B) = 0$ . Using Lemmas 9.16, 9.17 and 9.19 one could easily see that the only factor of  $\det(B)$  which could be zero is

$$c_4 k - c_2^3 k + 2c_2^2 k - 2c_2 k + c_2^3 c_4 - 2c_2^2 c_4 - c_2 c_4 + 2c_2^2.$$

Solving this for  $c_4$  and then computing  $\Delta_3$  using Definition 4.12, we obtain  $\Delta_3 = 0$ , a contradiction. This shows that  $v_3^+, v_3^-$  are linearly independent. ■

**Lemma 9.21** *With reference to Definition 9.7, assume that  $D = 5$ ,  $\Delta_2 = 0$  and  $\Delta_3 \neq 0$ . Then*

$$\|v_5^+\|^2 = \frac{b_4 - c_4 + \alpha_4 + c_2 \beta_4}{c_3} \|v_4^+\|^2.$$

*In particular,  $v_5^+ = 0$  if and only if  $v_4^+ = 0$  or  $b_4 - c_4 + \alpha_4 + c_2 \beta_4 = 0$ .*

PROOF. By Lemma 9.8(ii), (2.1) and Definition 5.19 we have

$$\langle v_5^+, v_5^+ \rangle = \frac{1}{c_3} \langle Rv_4^+, v_5^+ \rangle = \frac{1}{c_3} \langle v_4^+, Lv_5^+ \rangle.$$

The result now follows from Lemma 9.9(ii). ■



## 9.6 A basis

With reference to Definition 9.7, assume that  $D = 5$ ,  $\Delta_2 = 0$  and  $\Delta_3 \neq 0$ . In this section we display a basis for  $W$ . We will also show that, up to isomorphism,  $\Gamma$  has a unique irreducible  $T$ -module with endpoint 2.

**Theorem 9.22** *With reference to Definition 9.7, assume that  $D = 5$ ,  $\Delta_2 = 0$  and  $\Delta_3 \neq 0$ . Then the following (i)–(iii) hold.*

(i) *If  $v_5^+ \neq 0$ , then the following is a basis for  $W$ :*

$$v_i^+ \ (2 \leq i \leq 5), \quad v_3^-. \quad (9.5)$$

(ii) *If  $v_4^+ \neq 0$  and  $v_5^+ = 0$ , then the following is a basis for  $W$ :*

$$v_i^+ \ (2 \leq i \leq 4), \quad v_3^-. \quad (9.6)$$

(iii) *If  $v_4^+ = 0$ , then the following is a basis for  $W$ :*

$$v_i^+ \ (2 \leq i \leq 3), \quad v_3^-. \quad (9.7)$$

*In particular,  $W$  is not thin.*

PROOF. Note that by (9.4),  $W$  is spanned by vectors  $v_i^+$  ( $2 \leq i \leq 5$ ) and  $v_3^-$ . Vector  $v_2^+ = v$  is nonzero by definition. Vectors  $v_3^+$  and  $v_3^-$  are nonzero by Lemma 9.16 and Corollary 9.20(i), respectively. We prove part (i). Proofs of parts (ii) and (iii) are similar.

If  $v_5^+ \neq 0$ , then  $v_4^+ \neq 0$  by Lemma 9.21. Vectors  $v_i^+$  ( $2 \leq i \leq 5$ ) and  $v_3^-$  are linearly independent by (5.5) and Corollary 9.20(ii). This shows that (9.5) is a basis for  $W$ . As  $\dim(E_2^*(W)) = 2$ , the subspace  $W$  is not thin. The result follows. ■

**Theorem 9.23** *With reference to Definition 9.7, assume that  $D = 5$ ,  $\Delta_2 = 0$  and  $\Delta_3 \neq 0$ . Then  $\Gamma$  has, up to isomorphism, exactly one irreducible  $T$ -module with endpoint 2.*

PROOF. Let  $U$  denote an irreducible  $T$ -module with endpoint 2, different from  $W$ . Fix nonzero  $u \in E_2^*U$ , and for  $2 \leq i \leq 5$  define

$$u_i^+ = E_i^* A_{i-2} E_2^* u$$

and let  $u_3^- = E_3^* A_5 E_2^* u$ . It follows from the results of Section 9.5 and Theorem 9.22 that  $u_2^+, u_3^+, u_3^-$  are nonzero and that nonzero vectors in the set  $\{u_i^+ \mid 2 \leq i \leq 5\} \cup \{u_3^-\}$  form a basis for  $U$ . Furthermore, it follows from Lemma 9.18 and Lemma 9.21 that  $u_4^+$  ( $u_5^+$ , respectively) is nonzero if and only if  $v_4^+$  ( $v_5^+$ , respectively) is nonzero.

Let  $\sigma : W \rightarrow U$  be defined by  $\sigma(v_i^+) = u_i^+$  ( $2 \leq i \leq 5$ ) and  $\sigma(v_3^-) = u_3^-$ . It follows from the comments above that  $\sigma$  is a vector space isomorphism from  $W$  to  $U$ . We show that  $\sigma$  is a  $T$ -module isomorphism. Since  $A$  generates  $M$  and  $E_0^*, E_1^*, \dots, E_5^*$  is a basis for  $M^*$ , it suffices to show that  $\sigma$  commutes with each of  $A, E_0^*, E_1^*, \dots, E_D^*$ . Using the fact that  $E_i^* E_j^* = \delta_{ij} E_i^*$  and the definition of  $\sigma$  we immediately find that  $\sigma$  commutes with each of  $E_0^*, E_1^*, \dots, E_D^*$ . Recall that  $A = R + L$ . It follows from Lemma 9.8, Lemma 9.9 and Corollary 9.14 that  $\sigma$  commutes with  $A$ . The result follows. ■

With reference to Definition 9.7, assume that  $\Delta_2 = 0$  and  $\Delta_3 \neq 0$ . It is known that this implies  $c_2 \in \{1, 2\}$ , or  $D \leq 5$ , see Theorem 6.4. If  $c_2 \in \{1, 2\}$ , then the structure of irreducible  $T$ -modules with endpoint 2 was studied in detail in Chapters 7 and 8. Therefore,

we are mainly interested in the case  $c_2 \geq 3$ . We have to mention however that we are not aware of any of such a graph. Using a small computer program we found intersection arrays  $\{b_0, b_1, b_2, b_3, b_4; c_1, c_2, c_3, c_4, c_5\}$  up to valency  $k = 20000$ , which satisfy the following conditions:  $c_2 \geq 3$ ,  $\Delta_2 = 0$ ,  $\Delta_3 > 0$ ,  $\Delta_4 > 0$ ,  $\gamma_2 \in \mathbb{N}$ ,  $p_{22}^2 \in \mathbb{N}$ . None of them passed feasibility condition  $p_{ij}^1 \in \mathbb{N} \cup \{0\}$ , see the table below.

intersection arrays	feasibility condition
(58, 57, 49, 21, 1; 1, 9, 37, 57, 58)	$p_{23}^1 = 1102/3 \notin \mathbb{N}$
(112, 111, 100, 45, 4; 1, 12, 67, 108, 112)	$p_{34}^1 = 103600/67 \notin \mathbb{N}$
(186, 185, 161, 35, 1; 1, 25, 151, 185, 186)	$p_{23}^1 = 6882/5 \notin \mathbb{N}$
(274, 273, 256, 120, 10; 1, 18, 154, 264, 274)	$p_{23}^1 = 12467/3 \notin \mathbb{N}$
(274, 273, 256, 120, 1; 1, 18, 154, 273, 274)	$p_{23}^1 = 12467/3 \notin \mathbb{N}$
(1192, 1191, 1156, 561, 28; 1, 36, 631, 1164, 1192)	$p_{23}^1 = 118306/3 \notin \mathbb{N}$
(3236, 3235, 3136, 760, 1; 1, 100, 2476, 3235, 3236)	$p_{23}^1 = 523423/5 \notin \mathbb{N}$

However, together with the results from Chapters 7 and 8, paper [29], Theorems 9.22 and 9.23 imply the following characterization.

**Theorem 9.24** *Let  $\Gamma = (X, \mathcal{R})$  denote a bipartite distance-regular graph with diameter  $D \geq 4$  and valency  $k \geq 3$ . Assume  $\Gamma$  is not almost 2-homogeneous. We fix  $x \in X$  and let  $E_i^* = E_i^*(x)$  ( $0 \leq i \leq D$ ) and  $T = T(x)$  denote the dual idempotents and the Terwilliger algebra of  $\Gamma$  with respect to  $x$ , respectively. Then the following (i), (ii) are equivalent.*

- (i)  $\Gamma$  has, up to isomorphism, exactly one irreducible  $T$ -module  $W$  with endpoint 2, and  $W$  is non-thin with  $\dim(E_2^*W) = 1$ ,  $\dim(E_{D-1}^*W) \leq 1$  and  $\dim(E_i^*W) \leq 2$  for  $3 \leq i \leq D$ .
- (ii)  $\Delta_2 = 0$ , and there exist complex scalars  $\alpha_i, \beta_i$  ( $2 \leq i \leq D-1$ ) such that

$$|\Gamma_{i-1}(x) \cap \Gamma_{i-1}(y) \cap \Gamma_1(z)| = \alpha_i + \beta_i |\Gamma_1(x) \cap \Gamma_1(y) \cap \Gamma_{i-1}(z)| \quad (9.8)$$

for all  $y \in \Gamma_2(x)$  and  $z \in \Gamma_i(x) \cap \Gamma_i(y)$ .

---

# Bibliography

---

- [1] S. Axler, *Linear algebra done right*, Undergraduate Texts in Mathematics, Springer, Cham, 3rd edition, 2015, doi:10.1007/978-3-319-11080-6, <https://doi.org/10.1007/978-3-319-11080-6>. 6
- [2] E. Bannai and T. Ito, *Algebraic combinatorics. I*, The Benjamin/Cummings Publishing Co., Inc., Menlo Park, CA, 1984. 26, 95
- [3] A. E. Brouwer, A. M. Cohen and A. Neumaier, *Distance-regular graphs*, volume 18 of *Ergebnisse der Mathematik und ihrer Grenzgebiete (3) [Results in Mathematics and Related Areas (3)]*, Springer-Verlag, Berlin, 1989, doi:10.1007/978-3-642-74341-2, <http://dx.doi.org/10.1007/978-3-642-74341-2>. 3, 20, 25, 26, 50, 68, 70, 83, 96, 97
- [4] M. Cámara, J. Fàbrega, M. A. Fiol and E. Garriga, Some families of orthogonal polynomials of a discrete variable and their applications to graphs and codes, *Electron. J. Combin.* **16** (2009), Research Paper 83, 30, [http://www.combinatorics.org/Volume\\_16/Abstracts/v16i1r83.html](http://www.combinatorics.org/Volume_16/Abstracts/v16i1r83.html). 14, 15
- [5] J. S. Caughman, IV, The Terwilliger algebras of bipartite  $P$ - and  $Q$ -polynomial schemes, *Discrete Math.* **196** (1999), 65–95, doi:10.1016/S0012-365X(98)00196-4, [http://dx.doi.org/10.1016/S0012-365X\(98\)00196-4](http://dx.doi.org/10.1016/S0012-365X(98)00196-4). 2, 6, 70, 97
- [6] J. S. Caughman, IV, Bipartite  $Q$ -polynomial distance-regular graphs, *Graphs Combin.* **20** (2004), 47–57, doi:10.1007/s00373-003-0538-8, <http://dx.doi.org/10.1007/s00373-003-0538-8>. 2, 26, 29
- [7] K. Coolsaet and A. Jurišić, Using equality in the Krein conditions to prove nonexistence of certain distance-regular graphs, *J. Combin. Theory Ser. A* **115** (2008), 1086–1095, <https://doi.org/10.1016/j.jcta.2007.12.001>. 17
- [8] B. Curtin, 2-homogeneous bipartite distance-regular graphs, *Discrete Math.* **187** (1998), 39–70, doi:10.1016/S0012-365X(97)00226-4, [http://dx.doi.org/10.1016/S0012-365X\(97\)00226-4](http://dx.doi.org/10.1016/S0012-365X(97)00226-4). 2, 49, 84, 96
- [9] B. Curtin, Bipartite distance-regular graphs. I, *Graphs Combin.* **15** (1999), 143–158, doi:10.1007/s003730050049, <http://dx.doi.org/10.1007/s003730050049>. 1, 44, 46, 74, 95, 102
- [10] B. Curtin, Bipartite distance-regular graphs. II, *Graphs Combin.* **15** (1999), 377–391, doi:10.1007/s003730050072, <http://dx.doi.org/10.1007/s003730050072>. 1, 61, 74, 81
- [11] B. Curtin, The local structure of a bipartite distance-regular graph, *European J. Combin.* **20** (1999), 739–758, doi:10.1006/eujc.1999.0307, <http://dx.doi.org/10.1006/eujc.1999.0307>. 1, 61, 75, 82

- [12] B. Curtin, Almost 2-homogeneous bipartite distance-regular graphs, *European J. Combin.* **21** (2000), 865–876, doi:10.1006/eujc.2000.0399, <http://dx.doi.org/10.1006/eujc.2000.0399>. 2, 3, 40, 50, 53, 69, 79, 80, 96, 97
- [13] C. W. Curtis and I. Reiner, *Representation theory of finite groups and associative algebras*, Pure and Applied Mathematics, Vol. XI, Interscience Publishers, a division of John Wiley & Sons, New York-London, 1962.
- [14] E. van Dam, J. H. Koolen and H. Tanaka, *Distance-regular graphs*, Dynamic Surveys, Electron. J. Combin., 2016, <http://www.combinatorics.org/ojs/index.php/eljc/article/view/DS22/pdf>. 20, 41, 100
- [15] P. Delsarte and V. I. Levenshtein, Association schemes and coding theory, *IEEE Trans. Inform. Theory* **44** (1998), 2477–2504, doi:10.1109/18.720545, information theory: 1948–1998, <https://doi.org/10.1109/18.720545>. 6
- [16] G. A. Dickie, *Q-polynomial structures for association schemes and distance-regular graphs*, ProQuest LLC, Ann Arbor, MI, 1995, thesis (Ph.D.)—The University of Wisconsin - Madison, [http://gateway.proquest.com/openurl?url\\_ver=Z39.88-2004&rft\\_val\\_fmt=info:ofi/fmt:kev:mtx:dissertation&res\\_dat=xri:pqdiss&rft\\_dat=xri:pqdiss:9536154](http://gateway.proquest.com/openurl?url_ver=Z39.88-2004&rft_val_fmt=info:ofi/fmt:kev:mtx:dissertation&res_dat=xri:pqdiss&rft_dat=xri:pqdiss:9536154). 25, 26
- [17] E. S. Egge, A generalization of the Terwilliger algebra, *J. Algebra* **233** (2000), 213–252, doi:10.1006/jabr.2000.8420, <http://dx.doi.org/10.1006/jabr.2000.8420>. 61
- [18] M. A. Fiol, Algebraic characterizations of distance-regular graphs, *Discrete Math.* **246** (2002), 111–129, formal power series and algebraic combinatorics (Barcelona, 1999), [https://doi.org/10.1016/S0012-365X\(01\)00255-2](https://doi.org/10.1016/S0012-365X(01)00255-2). 12
- [19] M. A. Fiol, S. Gago and E. Garriga, A simple proof of the spectral excess theorem for distance-regular graphs, *Linear Algebra Appl.* **432** (2010), 2418–2422, <https://doi.org/10.1016/j.laa.2009.07.030>. 14, 15
- [20] M. A. Fiol and E. Garriga, From local adjacency polynomials to locally pseudo-distance-regular graphs, *J. Combin. Theory Ser. B* **71** (1997), 162–183, <https://doi.org/10.1006/jctb.1997.1778>. 15
- [21] J. T. Go, The Terwilliger algebra of the hypercube, *European J. Combin.* **23** (2002), 399–429, doi:10.1006/eujc.2000.0514, <http://dx.doi.org/10.1006/eujc.2000.0514>. 95
- [22] D. G. Higman, Coherent configurations. I. Ordinary representation theory, *Geometriae Dedicata* **4** (1975), 1–32, doi:10.1007/BF00147398, <https://doi.org/10.1007/BF00147398>. 10
- [23] D. G. Higman, Coherent algebras, *Linear Algebra Appl.* **93** (1987), 209–239, [https://doi.org/10.1016/S0024-3795\(87\)90326-0](https://doi.org/10.1016/S0024-3795(87)90326-0). 6, 10
- [24] S. Hobart and T. Ito, The structure of nonthin irreducible  $T$ -modules of endpoint 1: ladder bases and classical parameters, *J. Algebraic Combin.* **7** (1998), 53–75, doi:10.1023/A:1008619211978, <http://dx.doi.org/10.1023/A:1008619211978>. 3
- [25] A. J. Hoffman, On the polynomial of a graph, *Amer. Math. Monthly* **70** (1963), 30–36, <https://doi.org/10.2307/2312780>. 9

- [26] M. S. MacLean, The local eigenvalues of a bipartite distance-regular graph, *European J. Combin.* **45** (2015), 115–123, doi:10.1016/j.ejc.2014.10.011, <http://dx.doi.org/10.1016/j.ejc.2014.10.011>.
- [27] M. S. MacLean and Š. Miklavič, On bipartite distance-regular graphs with exactly two irreducible  $T$ -modules with endpoint two, *Linear Algebra Appl.* **515** (2017), 275 – 297, doi:http://dx.doi.org/10.1016/j.laa.2016.11.021, <http://www.sciencedirect.com/science/article/pii/S002437951630547X>. 2, 53, 69, 96
- [28] M. S. MacLean, Š. Miklavič and S. Penjić, On the Terwilliger algebra of bipartite distance-regular graphs with  $\Delta_2 = 0$  and  $c_2 = 1$ , *Linear Algebra Appl.* **496** (2016), 307–330, doi:10.1016/j.laa.2016.01.040, <http://dx.doi.org/10.1016/j.laa.2016.01.040>. 2, 52, 102
- [29] M. S. MacLean and Š. Miklavič, On bipartite distance-regular graphs with exactly one non-thin  $T$ -module with endpoint two, *European J. Combin.* **64** (2017), 125–137, doi:10.1016/j.ejc.2017.04.004, <https://doi.org/10.1016/j.ejc.2017.04.004>. 83, 86
- [30] M. S. MacLean and P. Terwilliger, Taut distance-regular graphs and the subconstituent algebra, *Discrete Math.* **306** (2006), 1694–1721, doi:10.1016/j.disc.2006.03.046, <http://dx.doi.org/10.1016/j.disc.2006.03.046>.
- [31] M. S. MacLean and P. Terwilliger, The subconstituent algebra of a bipartite distance-regular graph; thin modules with endpoint two, *Discrete Math.* **308** (2008), 1230–1259, doi:10.1016/j.disc.2007.03.071, <http://dx.doi.org/10.1016/j.disc.2007.03.071>.
- [32] W. J. Martin and H. Tanaka, Commutative association schemes, *European J. Combin.* **30** (2009), 1497–1525, doi:10.1016/j.ejc.2008.11.001, <https://doi.org/10.1016/j.ejc.2008.11.001>. 6
- [33] C. D. Meyer, *Matrix analysis and applied linear algebra (incl. CD-ROM and solutions manual)*, Philadelphia, PA: Society for Industrial and Applied Mathematics (SIAM), 2000. 11
- [34] Š. Miklavič, On bipartite  $Q$ -polynomial distance-regular graphs, *European J. Combin.* **28** (2007), 94–110, doi:10.1016/j.ejc.2005.09.003, <http://dx.doi.org/10.1016/j.ejc.2005.09.003>. 2, 26, 53, 97
- [35] Š. Miklavič, On bipartite  $Q$ -polynomial distance-regular graphs with  $c_2 = 1$ , *Discrete Math.* **307** (2007), 544–553, doi:10.1016/j.disc.2005.09.044, <http://dx.doi.org/10.1016/j.disc.2005.09.044>. 31, 37, 54, 55, 57, 102
- [36] Š. Miklavič, The Terwilliger algebra of a distance-regular graph of negative type, *Linear Algebra Appl.* **430** (2009), 251–270, doi:10.1016/j.laa.2008.07.013, <http://dx.doi.org/10.1016/j.laa.2008.07.013>. 48, 80
- [37] Š. Miklavič and S. Penjić, On the Terwilliger algebra of certain family of bipartite distance-regular graphs with  $\Delta_2 = 0$ , *accepted for publication, ADAM journal - The Art of Discrete and Applied Mathematics*, <https://adam-journal.eu/index.php/ADAM>. 79
- [38] Š. Miklavič and S. Penjić, On bipartite  $Q$ -polynomial distance-regular graphs with  $c_2 \leq 2$ , *Electron. J. Combin.* **21** (2014), #4.53. 29, 102
- [39] A. Neumaier, Krein conditions and near polygons, *J. Combin. Theory Ser. A* **54** (1990), 201–209, [https://doi.org/10.1016/0097-3165\(90\)90030-Z](https://doi.org/10.1016/0097-3165(90)90030-Z). 17

- [40] K. Nomura, Homogeneous graphs and regular near polygons, *J. Combin. Theory Ser. B* **60** (1994), 63–71, doi:10.1006/jctb.1994.1006, <http://dx.doi.org/10.1006/jctb.1994.1006>.
- [41] K. Nomura, A refinement of the split decomposition of a tridiagonal pair, *Linear Algebra Appl.* **403** (2005), 1–23, doi:10.1016/j.laa.2004.12.034, <http://dx.doi.org/10.1016/j.laa.2004.12.034>.
- [42] S. Penjić, *Algebraic characterizations of distance-regular graphs*, Master's thesis, University of Sarajevo, 2013. [12](#), [102](#)
- [43] S. Penjić, On the Terwilliger algebra of bipartite distance-regular graphs with  $\Delta_2 = 0$  and  $c_2 = 2$ , *Discrete Math.* **340** (2017), 452–466, doi:http://dx.doi.org/10.1016/j.disc.2016.09.001. [65](#)
- [44] J. J. Seidel, Strongly regular graphs, in: *Surveys in combinatorics (Proc. Seventh British Combinatorial Conf., Cambridge, 1979)*, Cambridge Univ. Press, Cambridge-New York, volume 38 of *London Math. Soc. Lecture Note Ser.*, pp. 157–180, 1979. [17](#)
- [45] P. Terwilliger, The subconstituent algebra of an association scheme. I, *J. Algebraic Combin.* **1** (1992), 363–388, doi:10.1023/A:1022494701663, <http://dx.doi.org/10.1023/A:1022494701663>. [95](#)
- [46] P. Terwilliger, The subconstituent algebra of an association scheme. II, *J. Algebraic Combin.* **2** (1993), 73–103, doi:10.1023/A:1022480715311, <http://dx.doi.org/10.1023/A:1022480715311>.
- [47] P. Terwilliger, The subconstituent algebra of an association scheme. III, *J. Algebraic Combin.* **2** (1993), 177–210, doi:10.1023/A:1022415825656, <http://dx.doi.org/10.1023/A:1022415825656>. [26](#), [47](#), [48](#)
- [48] P. Terwilliger, A new inequality for distance-regular graphs, *Discrete Math.* **137** (1995), 319–332, doi:10.1016/0012-365X(93)E0170-9, [http://dx.doi.org/10.1016/0012-365X\(93\)E0170-9](http://dx.doi.org/10.1016/0012-365X(93)E0170-9). [2](#), [24](#), [25](#), [97](#)
- [49] P. Terwilliger, Algebraic graph theory (MATH 846), January 2009., Lecture notes, University of Wisconsin. [5](#), [18](#), [42](#), [43](#), [44](#)
- [50] E. R. van Dam, The spectral excess theorem for distance-regular graphs: a global (over)view, *Electron. J. Combin.* **15** (2008), Research Paper 129, 10, [http://www.combinatorics.org/Volume\\_15/Abstracts/v15i1r129.html](http://www.combinatorics.org/Volume_15/Abstracts/v15i1r129.html).
- [51] B. Weisfeiler, *On construction and identification of graphs*, Lecture Notes in Mathematics, Vol. 558, Springer-Verlag, Berlin-New York, 1976, with contributions by A. Lehman, G. M. Adelson-Velsky, V. Arlazarov, I. Faragev, A. Uskov, I. Zuev, M. Rosenfeld and B. Weisfeiler, Edited by Boris Weisfeiler.

---

# Index

---

- $A_i$ , 5
- $E_i$ , 7
- $G_i(z)$ , 52, 69
- $H_i(z)$ , 52, 69
- $I_i(z)$ , 52, 69
- $T$ -module, 41
- $\mathcal{D}_j^i$ , 52, 65
- $\mathcal{D}_i^i(0)$ , 54, 66
- $\mathcal{D}_i^i(1)$ , 54, 66
- $\mathcal{D}_i^i(1)'$ , 66
- $\mathcal{D}_i^i(1)''$ , 66
- $\mathcal{D}_i^i(2)$ , 66
- $\Delta_i$ , 49
- $E_i^*$ , 41
- $\Gamma_{ij}(x, y)$ , 52, 65
- $\Lambda_i$ , 79
- $\alpha_i$ , 53
- $\beta_i$ , 53
- $\ell$ , 50, 54, 70
- $\gamma_i$ , 49
- $\omega_{ii}^+$ , 53
- $\omega_{ii}^-$ , 53
- $\omega_{ij}$ , 53
- $\phi$ -homogeneous component, 44
- $\rho(x)$ , 18
- $d$ -cube, 27
- $f$ , 50, 54, 70
- $v_i^+$ , 61, 74, 81
- $v_i^-$ , 61, 74, 81
- adjoint, 6
- algebra, 6
  - adjacency, 10
  - Bose-Mesner, 10
  - coherent, 6
  - dual Bose-Mesner, 41
  - Terwilliger, 41
- association scheme, 6
  - commutative, 6
  - symmetric, 6
- clique, 4
- corresponding parameters, 29
- diameter, 5
- direct sum, 5
- distance, 5
- dual bipartite, 26
- dual bipartite  $Q$ -polynomial structure, 26
- dual eigenvalue sequence
  - trivial, 24
- edge
  - loop, 4
- edges, 4
- eigenvalue, 24
  - multiplicity, 24
- equitable partition, 29
- graph, 4
  - $Q$ -polynomial with respect to  $E$ , 25
  - $Q$ -polynomial with respect to  $\theta$ , 25
  - $d$ -dimensional hypercube, 27
  - antipodal, 28
  - antipodal quotient, 28
  - bipartite, 22
  - connected, 5
  - distance-regular, 5, 20
  - dual bipartite, 26
  - finite, 4
  - Hamming, 27
  - Johnson, 27
  - regular, 5
  - simple, 4
- half cube, 28
- inner product, 13
- intersection numbers, 21
- irreducible module

- multiplicity, 44
- isomorphism of  $T$ -modules, 42
- Krein parameters, 16, 25
- linear operator
  - projector, 5
- loop, 4
- matrices
  - lowering, 48
  - raising, 48
- matrix
  - adjacency, 5
  - distance- $i$ , 5
- module
  - diameter, 42
  - endpoint, 42
  - irreducible, 41
  - primary, 45
  - standard, 4, 23
  - thin, 47
  - thin with respect to  $x$ , 42
- modules
  - isomorphic, 42
- numbers
  - intersection, 21
- operator
  - normal, 6
  - self-adjoint, 6
- orthogonal projector, 6
- predistance polynomials, 16
- primitive idempotents, 7
- sequence
  - dual eigenvalue, 24
- standard module, 23
- structure
  - dual bipartite, 26
- subalgebra
  - self-adjoint, 6
- subspaces
  - complementary, 5
- vector
  - orthogonal projection, 5
  - projection, 5
- vertex
  - valency, 5
- vertices, 4
  - adjacent, 4
  - neighbors, 4
- walk, 5
  - closed, 5



---

# List of Figures

---

2.1	$E_i$ projects on the $\lambda_i$ -eigenspace $V_i$ . . . . .	10
3.1	Intersection diagram (of rank 0) with respect to $x$ and illustration for coefficients $c_h, a_h$ and $b_h$ . . . . .	20
4.1	The partition of graph $\Gamma$ with respect to $x \in X, y \in \Gamma_2(x)$ and $z, v \in \Gamma_{11}(x, y)$ . . . . .	33
7.1	The partition with reference to Definition 7.8, when $\ell \leq D - 2$ . Observe that $\Gamma_i(x) = \mathcal{D}_{i+2}^i \cup \mathcal{D}_i^i(0) \cup \mathcal{D}_i^i(1) \cup \mathcal{D}_{i-2}^i$ and $\Gamma_i(y) = \mathcal{D}_i^{i-2} \cup \mathcal{D}_i^i(0) \cup \mathcal{D}_i^i(1) \cup \mathcal{D}_i^{i+2}$ ( $2 \leq i \leq D$ ). . . . .	57
8.1	The partition of graph $\Gamma$ , with reference to Definition 8.3. Observe that $\Gamma_i(x) = \mathcal{D}_{i+2}^i \cup \mathcal{D}_i^i(0) \cup \mathcal{D}_i^i(1)' \cup \mathcal{D}_i^i(1)'' \cup \mathcal{D}_i^i(2) \cup \mathcal{D}_{i-2}^i$ (disjoint union) and $\Gamma_i(y) = \mathcal{D}_i^{i-2} \cup \mathcal{D}_i^i(0) \cup \mathcal{D}_i^i(1)' \cup \mathcal{D}_i^i(1)'' \cup \mathcal{D}_i^i(2) \cup \mathcal{D}_i^{i+2}$ (disjoint union). . . . .	67

---

# Povzetek v slovenskem jeziku

---

## O Terwilligerjevi algebri dvodelnih razdaljno-regularnih grafov

### Teoretična izhodišča

Naj bo  $\mathbb{C}$  obseg kompleksnih števil in naj bo  $X$  neprazna končna množica. Naj  $\text{Mat}_X(\mathbb{C})$  označuje  $\mathbb{C}$ -algebro, ki vsebuje vse kvadratne matrike s kompleksnimi koeficienti, ki imajo vrstice in stolpce indeksirane z elementi množice  $X$ . Naj bo  $V = \mathbb{C}^X$  vektorski prostor nad obsegom  $\mathbb{C}$ , ki ga sestavljajo vsi stolpčni vektorji s kompleksnim komponentami, ki imajo vrstice indeksirane z elementi množice  $X$ . Opazimo, da  $\text{Mat}_X(\mathbb{C})$  deluje na  $V$  z levim množenjem. Prostoru  $V$  pravimo *standardni modul*. Na prostoru  $V$  definirajmo skalarni produkt  $\langle \cdot, \cdot \rangle$ :  $\langle u, v \rangle = u^t \bar{v}$  za vse  $u, v \in V$ , kjer  $t$  označuje transponiranje in  $\bar{\cdot}$  označuje kompleksno konjugacijo. Za vsak  $y \in X$  naj bo  $\hat{y}$  vektor iz  $V$ , ki ima  $y$ -koordinato enako 1, vse ostale koordinate pa enake 0. Tedaj je množica

$$\{\hat{y} \mid y \in X\} \tag{1}$$

ortonormirana baza za  $V$ .

Naj bo  $\Gamma = (X, R)$  končen neusmerjen povezan graf brez zank in večkratnih povezav, z množico vozlišč  $X$  in množico povezav  $R$ . *Ekvitalna particija* grafa je particija  $\pi = \{C_1, C_2, \dots, C_s\}$  njegove množice vozlišč, tako da je za poljubni celi števili  $i, j$  ( $1 \leq i, j \leq s$ ), število sosedov, ki jih ima neko vozlišče iz množice  $C_i$  v množici  $C_j$ , neodvisno od izbire vozlišča iz množice  $C_i$ . To število sosedov označimo s  $c_{ij}$ . Številom  $c_{ij}$  ( $1 \leq i, j \leq s$ ) pravimo *parametri* ekvitalne particije  $\pi$ .

Za poljubni vozlišči  $x, y \in X$  označimo z  $\partial(x, y)$  njuno medsebojno razdaljo. Naj bo  $D := \max\{\partial(x, y) \mid x, y \in X\}$  *premer* (diameter) grafa  $\Gamma$ . Za vozlišče  $x \in X$  in celo število  $i$  naj bo  $\Gamma_i(x)$  množica vseh vozlišč, ki so na razdalji  $i$  od  $x$ . Naj bo  $k$  celo nenegativno število. Graf  $\Gamma$  je *regularen s stopnjo  $k$* , če je  $|\Gamma_1(x)| = k$  za vsak  $x \in X$ . Graf  $\Gamma$  je *razdaljno-regularen*, če za poljubna cela števila  $h, i, j$  ( $0 \leq h, i, j \leq D$ ), in za poljubni vozlišči  $x, y \in X$  z lastnostjo  $\partial(x, y) = h$  velja, da je število

$$p_{ij}^h = |\Gamma_i(x) \cap \Gamma_j(y)|$$

neodvisno od izbire vozlišč  $x$  in  $y$ . Številom  $p_{ij}^h$  pravimo *presečna števila* grafa  $\Gamma$ . Seveda velja  $p_{ij}^h = p_{ji}^h$  za  $0 \leq h, i, j \leq D$ . Zaradi poenostavitve notacije definirajmo  $c_i := p_{1, i-1}^i$  ( $1 \leq i \leq D$ ),  $a_i := p_{1i}^i$  ( $0 \leq i \leq D$ ),  $b_i := p_{1, i+1}^i$  ( $0 \leq i \leq D-1$ ),  $k_i := p_{ii}^0$  ( $0 \leq i \leq D$ ), ter  $c_0 = b_D = 0$ . Od sedaj naprej predpostavimo, da je  $\Gamma$  razdaljno-regularen graf valence  $k \geq 3$  in premera  $D \geq 3$ .

Ponovimo sedaj nekaj osnovnih definicij iz algebraične teorije grafov. Za  $0 \leq i \leq D$  naj  $A_i$  označuje matriko v  $\text{Mat}_X(\mathbb{C})$ , ki ima  $(x, y)$ -element definiran s predpisom

$$(A_i)_{xy} = \begin{cases} 1 & \text{če } \partial(x, y) = i, \\ 0 & \text{če } \partial(x, y) \neq i \end{cases} \quad (x, y \in X).$$

Izkaže se, da je za  $i < 0$  in  $i > D$  prikladno definirati matriko  $A_i$  kot ničelno matriko iz  $\text{Mat}_X(\mathbb{C})$ . Matrika  $A_i$  se imenuje  $i$ -ta *razdaljna matrika* grafa  $\Gamma$ . Matriki  $A_1$  pravimo *matrika sosednosti* grafa  $\Gamma$  in jo krajše označimo tudi z  $A$ . Znano je, da so matrike  $A_0, A_1, \dots, A_D$  baza komutativne podalgebre  $M$  algebre  $\text{Mat}_X(\mathbb{C})$ . Algebri  $M$  pravimo *Bose-Mesnerjeva algebra* grafa  $\Gamma$ . Izkaže se, da matrika  $A$  generira  $M$  [2, str. 190].

Sedaj bomo definirali dualne idempotente grafa  $\Gamma$ . S tem namenom fiksirajmo vozlišče  $x \in X$ . Za  $0 \leq i \leq D$  naj bo  $E_i^* = E_i^*(x)$  diagonalna matrika v  $\text{Mat}_X(\mathbb{C})$  z  $(y, y)$ -elementom

$$(E_i^*)_{yy} = \begin{cases} 1 & \text{če } \partial(x, y) = i, \\ 0 & \text{če } \partial(x, y) \neq i \end{cases} \quad (y \in X). \quad (2)$$

Matriki  $E_i^*$  pravimo  $i$ -ti *dualni idempotent* grafa  $\Gamma$  glede na vozlišče  $x$  [45, str. 378]. Znano je, da so matrike  $E_0^*, E_1^*, \dots, E_D^*$  baza komutativne podalgebre  $M^* = M^*(x)$  algebre  $\text{Mat}_X(\mathbb{C})$ . Podalgebri  $M^*$  pravimo *dualna Bose-Mesnerjeva algebra* grafa  $\Gamma$  glede na vozlišče  $x$  [45, p. 378]. Za  $0 \leq i \leq D$  velja

$$E_i^*V = \text{span}\{\hat{y} \mid y \in X, \partial(x, y) = i\},$$

ter  $\dim(E_i^*V) = k_i$ . Opazimo tudi, da velja

$$V = E_0^*V + E_1^*V + \dots + E_D^*V \quad (\text{ortogonalna direktna vsota}). \quad (3)$$

Matrika  $E_i^*$  predstavlja projekcijo prostora  $V$  na podprostor  $E_i^*V$  za  $0 \leq i \leq D$ .

Naj bo  $T = T(x)$  podalgebra algebre  $\text{Mat}_X(\mathbb{C})$ , ki je generirana s podalgebrama  $M, M^*$ . Podalgebri  $T$  pravimo *Terwilligerjeva algebra* grafa  $\Gamma$  glede na vozlišče  $x$  [45, Definicija 3.3]. Ker je  $M$  generirana z matriko  $A$ , je  $T$  generirana z matriko  $A$  in z dualnim idempotenti  $E_i^*$  ( $0 \leq i \leq D$ ). Algebra  $T$  ima končno dimenzijo. Po konstrukciji je  $T$  zaprta glede na operaciji konjugacije in transponiranja. Zato je algebra  $T$  polenostavna [45, Lema 3.4(i)].

Podprostor  $W$  prostora  $V$  je  $T$ -modul, če je  $BW \subseteq W$  za vsak  $B \in T$ . Naj bo  $W$   $T$ -modul. Pravimo, da je  $W$  *nerazcepen*, če je neničelen, ter sta edina  $T$ -modula, ki jih  $W$  vsebuje, ničelni  $T$ -modul ter  $T$ -modul  $W$ .

Po [21, Posledica 6.2] je vsak  $T$ -modul ortogonalna direktna vsota nerazcepnih  $T$ -modulov. Zato je tudi standardni modul  $V$  ortogonalna direktna vsota nerazcepnih  $T$ -modulov. Naj bosta  $W, W'$  poljubna  $T$ -modula. *Izomorfizem  $T$ -modulov*  $W$  in  $W'$  je izomorfizem vektorskih prostorov  $\sigma : W \rightarrow W'$ , za katerega velja, da je  $(\sigma B - B\sigma)W = 0$  za vsak  $B \in T$ . Za  $T$ -modula  $W, W'$  pravimo, da sta *izomorfna*, če obstaja izomorfizem  $T$ -modulov  $W$  in  $W'$ . Po [9, Lema 3.3] sta poljubna dva neizomorfna  $T$ -modula ortogonalna. Naj bo  $W$  nerazcepen  $T$ -modul. Po [45, Lema 3.4(iii)] je  $W$  ortogonalna direktna vsota tistih prostorov  $E_0^*W, E_1^*W, \dots, E_D^*W$ , ki so neničelni. *Krajšiče  $T$ -modula*  $W$  je definirano kot  $\min\{i \mid 0 \leq i \leq D, E_i^*W \neq 0\}$ . *Diameter*  $T$ -modula  $W$  je definiran kot  $|\{i \mid 0 \leq i \leq D, E_i^*W \neq 0\}| - 1$ .  $T$ -modul  $W$  je *tanek*, če je  $\dim(E_i^*W) \leq 1$  za  $0 \leq i \leq D$ .

Pojasnimo sedaj motivacijo za doktorsko disertacijo. V ta namen najprej s presečnimi števili grafa  $\Gamma$  definirajmo parametre  $\Delta_i$  ( $1 \leq i \leq D - 1$ ) s predpisom:

$$\Delta_i = (b_{i-1} - 1)(c_{i+1} - 1) - (c_2 - 1)p_{2i}^i.$$

Oglejmo si naslednje lastnosti, ki jih ima lahko dvodelen razdaljno-regularen graf  $\Gamma$ :

- (a.1)  $\Gamma$  ima, do izomorfizma natančno, enolično določen nerazcepen  $T$ -modul s krajiščem 2, in ta modul je tanek.
- (a.2)  $\Gamma$  ima, do izomorfizma natančno, natanko dva nerazcepna  $T$ -modula s krajiščem 2, in ta modula sta tanka.
- (a.3)  $\Gamma$  ima, do izomorfizma natančno, enolično določen nerazcepen  $T$ -modul s krajiščem 2, ta modul ni tanek,  $\dim(E_2^*W) = 1$ ,  $\dim(E_i^*W) \leq 2$  za vsak  $i$  ( $3 \leq i \leq D$ ) in  $\dim(E_{D-1}^*W) \leq 1$ .
- (a.4)  $\Delta_i = 0$  za vsak  $i$  ( $2 \leq i \leq D - 1$ ).
- (a.5)  $\Delta_i = 0$  za vsak  $i$  ( $2 \leq i \leq D - 2$ ).
- (a.6) Za vsak  $i$  ( $1 \leq i \leq D - 2$ ) in za vse  $x, y, z \in X$  z  $\partial(x, y) = 2$ , za katere velja  $\partial(x, z) = i$ ,  $\partial(y, z) = i$ , je število  $|\Gamma_1(x) \cap \Gamma_1(y) \cap \Gamma_{i-1}(z)|$  neodvisno od izbire vozlišč  $x, y, z$ .
- (a.7)  $\Gamma$  ima lastnost, da za vsak  $2 \leq i \leq D - 1$  obstajajo taka kompleksna števila  $\alpha_i, \beta_i$ , da za vse  $x, y, z \in X$  z lastnostjo  $\partial(x, y) = 2$ ,  $\partial(x, z) = i$ ,  $\partial(y, z) = i$  velja, da je  $\alpha_i + \beta_i |\Gamma_1(x) \cap \Gamma_1(y) \cap \Gamma_{i-1}(z)| = |\Gamma_{i-1}(x) \cap \Gamma_{i-1}(y) \cap \Gamma_1(z)|$ .
- (a.8)  $\Gamma$  ima lastnost, da za vsak  $2 \leq i \leq D - 2$  obstajajo taka kompleksna števila  $\alpha_i, \beta_i$ , da za vse  $x, y, z \in X$  z lastnostjo  $\partial(x, y) = 2$ ,  $\partial(x, z) = i$ ,  $\partial(y, z) = i$  velja, da je  $\alpha_i + \beta_i |\Gamma_1(x) \cap \Gamma_1(y) \cap \Gamma_{i-1}(z)| = |\Gamma_{i-1}(x) \cap \Gamma_{i-1}(y) \cap \Gamma_1(z)|$ .
- (a.9)  $\Delta_2 > 0$  in  $\Gamma$  ima lastnost (a.8).
- (a.10)  $\Delta_2 = 0$ ,  $\Delta_i \neq 0$  za nek  $i$  ( $3 \leq i \leq D - 2$ ) in  $\Gamma$  ima lastnost (a.7).

V člankih [8, 12] je Curtin pokazal, da so lastnosti (a.1), (a.5) in (a.6) ekvivalentne. Poleg tega je Curtin tudi pokazal, da v tem primeru velja (a.4) natanko takrat, ko ima do izomorfizma natančno enolično določen nerazcepen  $T$ -modul s krajiščem 2 diameter  $D - 4$ . V [27, Izrek 9.6] sta MacLean in Miklavič pokazala, da sta lastnosti (a.2) in (a.9) ekvivalentni.

Definirajmo sedaj še  $Q$ -polinomsko lastnost grafa  $\Gamma$ . V ta namen se najprej spomnimo, kaj so primitivni idempotenti, lastne vrednosti in Kreinovi parametri grafa  $\Gamma$ . Po [3, str. 45] ima  $M$  še eno bazo  $\{E_i\}_{i=0}^D$ , za katero velja

$$(ei) \quad E_0 = |X|^{-1}J;$$

$$(eii) \quad I = \sum_{i=0}^D E_i;$$

$$(eiii) \quad E_i^t = E_i \quad (0 \leq i \leq D);$$

$$(eiv) \quad E_i E_j = \delta_{ij} E_i \quad (0 \leq i, j \leq D).$$

Matrikam  $\{E_i\}_{i=0}^D$  pravimo *primitivni idempotenti* grafa  $\Gamma$ . Matriki  $E_0$  pravimo *trivialni primitivni idempotent* grafa  $\Gamma$ . Iz lastnosti (eii)–(eiv) sledi

$$V = E_0 V + E_1 V + \dots + E_D V \quad (\text{ortogonalna direktna vsota}). \quad (4)$$

Ker zaporedje matrik  $\{E_i\}_{i=0}^D$  formira bazo algebre  $M$ , obstajajo taka kompleksna števila  $\{\theta_i\}_{i=0}^D$ , da je  $A = \sum_{i=0}^D \theta_i E_i$ . Ker je  $A$  realna simetrična matrika, ki generira  $M$ , se izkaže, da so števila  $\theta_i$  realna. Zgornja enakost v kombinaciji z (eiv) nam da

$$A E_i = E_i A = \theta_i E_i \quad (0 \leq i \leq D).$$

Številu  $\theta_i$  pravimo *lastna vrednost* grafa  $\Gamma$  (pripadajoča matriki  $E_i$ ). Podprostor  $E_i V$  ( $0 \leq i \leq D$ ) je lastni prostor matrike  $A$  za lastno vrednost  $\theta_i$ . Naj bo  $m_i$  rang matrike  $E_i$  ( $0 \leq i \leq D$ ). Opazimo, da je  $m_i$  dimenzija lastnega prostora  $E_i V$  ( $0 \leq i \leq D$ ). Številu  $m_i$  pravimo tudi *večkratnost* lastne vrednosti  $\theta_i$ . Opazimo, da so lastne vrednosti iz zaporedja  $\{\theta_i\}_{i=0}^D$  med seboj različne, ker  $A$  generira  $M$ . Iz (ei) sledi, da je  $\theta_0 = k$ .

Naj bo  $\circ$  operacija množenja matrik po komponentah (imenovana tudi Hadamardovo množenje matrik). Opazimo, da je  $A_i \circ A_j = \delta_{ij} A_i$  za vse  $0 \leq i, j \leq D$ . Iz tega sledi, da je  $M$  zaprta glede na operacijo  $\circ$ . Zato obstajajo taka števila  $q_{ij}^h \in \mathbb{C}$  ( $0 \leq h, i, j \leq D$ ), da velja

$$E_i \circ E_j = |X|^{-1} \sum_{h=0}^D q_{ij}^h E_h \quad (0 \leq i, j \leq D).$$

Pravimo jim *Kreinovi parametri* grafa  $\Gamma$ . Po [3, Trditev 4.1.5] so Kreinovi parametri grafa  $\Gamma$  realna nenegativna števila.

Definirajmo sedaj  $Q$ -polinomsko lastnost grafa  $\Gamma$ . Naj bo  $\{E_i\}_{i=0}^D$  zaporedje primitivnih idempotentov grafa  $\Gamma$ . Za to zaporedje rečemo, da je  $Q$ -polinomsko, če za  $0 \leq h, i, j \leq D$  velja, da je Kreinov parameter  $q_{ij}^h = 0$  (oz.  $q_{ij}^h \neq 0$ ) kadarkoli je eno od števil  $h, i, j$  večje od vsote preostalih dveh (oz. enako vsoti preostalih dveh). Naj bo  $E$  netrivialni primitivni idempotent grafa  $\Gamma$  in naj bo  $\theta$  pridružena lastna vrednost. Pravimo, da je  $\Gamma$   $Q$ -polinomski glede na  $E$  (oziroma  $Q$ -polinomski glede na lastno vrednost  $\theta$ ), če obstaja  $Q$ -polinomsko zaporedje primitivnih idempotentov  $\{E_i\}_{i=0}^D$ , tako da je  $E_1 = E$ .

## Identifikacija problema

Spomnimo se lastnosti (a.1)–(a.10) iz poglavja 1. V doktorski disertaciji smo pokazali, da lastnost (a.10) implicira lastnost (a.3). Lastnost (a.10) po definiciji vsebuje lastnost (a.7). Dvodelni razdaljno-regularni grafi, ki imajo lastnost (a.7), nas zanimajo zato, ker ima to lastnost pomembna družina dvodelnih razdaljno-regularnih grafov. Oglejmo si to družino v naslednjem primeru. Naj bo graf  $\Gamma$   $Q$ -polinomski. Potem ima  $\Gamma$ , do izomorfizma natančno, največ en nerazcepen  $T$ -modul s krajiščem 2 in diametrom  $D - 2$ , največ en nerazcepen  $T$ -modul s krajiščem 2 in diametrom  $D - 4$  (oba ta modula sta tanka) in nobenega drugega nerazcepnega  $T$ -modula s krajiščem 2, glej [5]. Poleg tega nam Terwilligerjev *pogoj uravnoteženih množic* ([48, izrek 3.3]) pove, da ima graf  $\Gamma$  lastnost (a.7) ([34, izrek 9.1]).

V prvem delu disertacije (Poglavje 4) smo predpostavili, da je  $\Gamma$  dvodelen  $Q$ -polinomski razdaljno-regularen graf z premerom  $D \geq 4$ , stopnje  $k \geq 3$  in presečnimi števili  $b_i, c_i$ . Caughman je v članku [5] dokazal, da če je  $D \geq 12$ , potem je  $\Gamma$  bodisi  $D$ -dimenzionalna hiperkocka, bodisi antipodni kvocient  $2D$ -dimenzionalne hiperkocke, bodisi so presečna števila grafa  $\Gamma$  oblike  $c_i = (q^i - 1)/(q - 1)$  ( $0 \leq i \leq D$ ) za neko celo število  $q \geq 2$ . Če je  $c_2 \leq 2$ , potem zadnja od zgornjih treh možnost ni mogoča. Cilj te doktorske disertacije je tudi nadaljevanje študija teh grafov. Pokazali smo, da je v primeru ko je  $c_2 \leq 2$ , graf  $\Gamma$  bodisi  $D$ -dimenzionalna hiperkocka, bodisi antipodni kvocient  $2D$ -dimenzionalne hiperkocke, bodisi je  $D = 5$ .

V drugem delu te doktorske disertacije (Poglavja 7, 8, 9) nismo predpostavili  $Q$ -polinomske lastnosti grafa  $\Gamma$ . Namesto tega smo predpostavili, da ima graf  $\Gamma$  lastnost (a.7), skupaj s pogojem  $\Delta_2 = 0$ . Naš cilj je, da v tem primeru opišemo nerazcepne  $T$ -module s krajiščem 2. Predpostavili smo tudi, da je  $\Delta_i \neq 0$  za nek  $i$  ( $3 \leq i \leq D - 2$ ), saj nerazcepne  $T$ -module s krajiščem 2 za grafe z lastnostjo (a.4) že dobro razumemo [12]. Najprej smo pokazali, da v primeru, ko je  $c_2 \leq 2$ , obstaja neka ekvitalna particija množice vozlišč grafa  $\Gamma$ . Ta particija v primeru  $c_2 = 1$  vsebuje  $3(D - 1) + \ell$  množic, v primeru  $c_2 = 2$  pa  $4(D - 1) + 2\ell$  množic za neko celo število  $\ell$  z  $0 \leq \ell \leq D - 2$ . To ekvitalno particijo smo uporabili za opis nerazcepnih  $T$ -modulov s krajiščem 2.

## Glavni rezultati

**Definicija 1** Naj bo  $\Gamma = (X, R)$  dvodelen razdaljno-regularen graf s premerom  $D \geq 4$ , stopnjo  $k \geq 3$  in presečnimi števili  $b_i, c_i$ . Za  $2 \leq i \leq D - 1$  definirajmo

$$\Delta_i = (b_{i-1} - 1)(c_{i+1} - 1) - (c_2 - 1)p_{2i}^i.$$

V doktorski disertaciji smo dokazali naslednji rezultat.

**Izrek 2** (glej izrek 6.4) *Z notacijo iz definicije 1, če je  $\Delta_2 = 0$ , potem je  $D \leq 5$  ali  $c_2 \in \{1, 2\}$ .*

**Definicija 3** Naj bo  $\Gamma = (X, R)$  dvodelen razdaljno-regularen graf s premerom  $D \geq 4$ , stopnjo  $k \geq 3$  in presečnimi števili  $b_i, c_i$ . Izberimo si poljubno vozlišče  $x \in X$ . Za vsak  $y \in \Gamma_2(x)$  in za vsa cela števila  $i, j$  definirajmo  $\mathcal{D}_j^i = \mathcal{D}_j^i(x, y)$  kot

$$\mathcal{D}_j^i := \Gamma_{ij}(x, y) = \Gamma_i(x) \cap \Gamma_j(y).$$

**Definicija 4** Privzemimo notacijo definicije 3. Naj bo  $y \in \Gamma_2(x)$ . Definirajmo preslikave  $G_i, H_i, I_i : \mathcal{D}_i^i \rightarrow \mathbb{N} \cup \{0\}$  ( $2 \leq i \leq D - 1$ ) na naslednji način. Za  $z \in \mathcal{D}_i^i$  naj bo

$$G_i(z) = |\Gamma_{i-1}(z) \cap \mathcal{D}_1^1|, \quad H_i(z) = |\Gamma_1(z) \cap \mathcal{D}_{i-1}^{i-1}|, \quad I_i(z) = 1.$$

### Ekvitalna particija za primer, ko je $c_2 = 1$

Opišimo si sedaj ekvitalno particijo grafa  $\Gamma$ , ki ima lastnost (a.7), v primeru, ko je  $c_2 = 1$ .

**Definicija 5** Z notacijo iz definicije 3, izberimo  $y \in \Gamma_2(x)$ . Naj bo  $w$  (enolično določen) skupni sosed vozlišč  $x, y$ . Potem za  $1 \leq i \leq D$  definiramo  $\mathcal{D}_i^i(0) = \mathcal{D}_i^i(0)(x, y)$ ,  $\mathcal{D}_i^i(1) = \mathcal{D}_i^i(1)(x, y)$  z

$$\mathcal{D}_i^i(0) = \{z \in \mathcal{D}_i^i \mid \partial(w, z) = i + 1\}, \quad \mathcal{D}_i^i(1) = \{z \in \mathcal{D}_i^i \mid \partial(w, z) = i - 1\}.$$

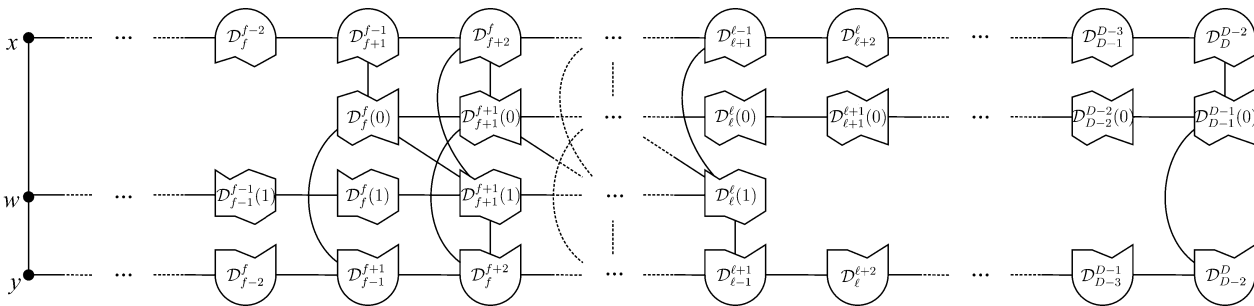

SLIKA 1. Particija množice vozlišč grafa  $\Gamma$  (glej definicijo 6). Opazimo, da je  $\Gamma_i(x) = \mathcal{D}_{i+2}^i \cup \mathcal{D}_i^i(0) \cup \mathcal{D}_i^i(1) \cup \mathcal{D}_{i-2}^i$  (disjunktna unija) in  $\Gamma_i(y) = \mathcal{D}_i^{i-2} \cup \mathcal{D}_i^i(0) \cup \mathcal{D}_i^i(1) \cup \mathcal{D}_i^{i+2}$  (disjunktna unija).

**Definicija 6** Naj bo  $\Gamma = (X, R)$  dvodelen razdaljno-regularen graf s premerom  $D \geq 4$ , stopnjo  $k \geq 3$  in presečnimi števili  $b_i, c_i$ . Predpostavimo, da je  $\Delta_2 = 0$ ,  $c_2 = 1$  in  $\Delta_i = (b_{i-1} - 1)(c_{i+1} - 1) \neq 0$  za nek  $i$  ( $3 \leq i \leq D - 2$ ). Naj bo

$$f = \min\{i \in \mathbb{N} \mid 3 \leq i \leq D - 2 \text{ in } \Delta_i \neq 0\},$$

$$\ell = \max\{i \in \mathbb{N} \mid 3 \leq i \leq D - 1 \text{ in } \Delta_i \neq 0\}.$$

Za poljubnen  $y \in \Gamma_2(x)$  definirajmo  $\mathcal{D}_j^i$ ,  $\mathcal{D}_i^i(0)$  in  $\mathcal{D}_i^i(1)$  ( $0 \leq i, j \leq D$ ) kot v definiciji 3 in definiciji 5. Predpostavimo, da za  $f \leq i \leq \ell$  obstajata kompleksni števili  $\alpha_i, \beta_i$ , tako da za vsak  $y \in \Gamma_2(x)$  velja  $H_i = \alpha_i I_i + \beta_i G_i$ , kjer so  $G_i, H_i, I_i$  kot v definiciji 4.

V doktorski disertaciji smo dokazali naslednji izrek.

**Izrek 7** (glej podpoglavje 7.2) *Z notacijo iz definicije 6, naj bo  $y \in \Gamma_2(x)$ . Potem je particija množice  $X$  na neprazne množice  $\mathcal{D}_{i+1}^{i-1}$ ,  $\mathcal{D}_{i-1}^{i+1}$  ( $1 \leq i \leq D-1$ ),  $\mathcal{D}_i^i(0)$  ( $f \leq i \leq D-1$ ) in  $\mathcal{D}_i^i(1)$  ( $1 \leq i \leq \ell$ ) ekvitalna. Pripadajoči parametri te ekvitalne particije so neodvisni od izbire vozlišč  $x, y$ .*

### Ekvitalna particija za primer, ko je $c_2 = 2$

Opišimo si sedaj ekvitalno particijo grafa  $\Gamma$ , ki ima lastnost (a.7), v primeru, ko je  $c_2 = 2$ .

**Definicija 8** *Z notacijo iz definicije 3, naj bo  $y \in \Gamma_2(x)$ . Predpostavimo, da je  $c_2 = 2$  in naj bosta  $\bar{x}, \bar{y}$  skupna soseda vozlišč  $x$  in  $y$ . Za vsa cela števila  $i$  definirajmo množice  $\mathcal{D}_i^i(0) = \mathcal{D}_i^i(0)(x, y)$ ,  $\mathcal{D}_i^i(1)' = \mathcal{D}_i^i(1)'(x, y)$ ,  $\mathcal{D}_i^i(1)'' = \mathcal{D}_i^i(1)''(x, y)$  in  $\mathcal{D}_i^i(2) = \mathcal{D}_i^i(2)(x, y)$  s predpisi*

$$\begin{aligned} \mathcal{D}_i^i(0) &= \{w \in \mathcal{D}_i^i \mid \partial(\bar{x}, w) = i+1, \partial(\bar{y}, w) = i+1\}, \\ \mathcal{D}_i^i(1)' &= \{w \in \mathcal{D}_i^i \mid \partial(\bar{x}, w) = i-1, \partial(\bar{y}, w) = i+1\}, \\ \mathcal{D}_i^i(1)'' &= \{w \in \mathcal{D}_i^i \mid \partial(\bar{x}, w) = i+1, \partial(\bar{y}, w) = i-1\}, \\ \mathcal{D}_i^i(2) &= \{w \in \mathcal{D}_i^i \mid \partial(\bar{x}, w) = i-1, \partial(\bar{y}, w) = i-1\}. \end{aligned}$$

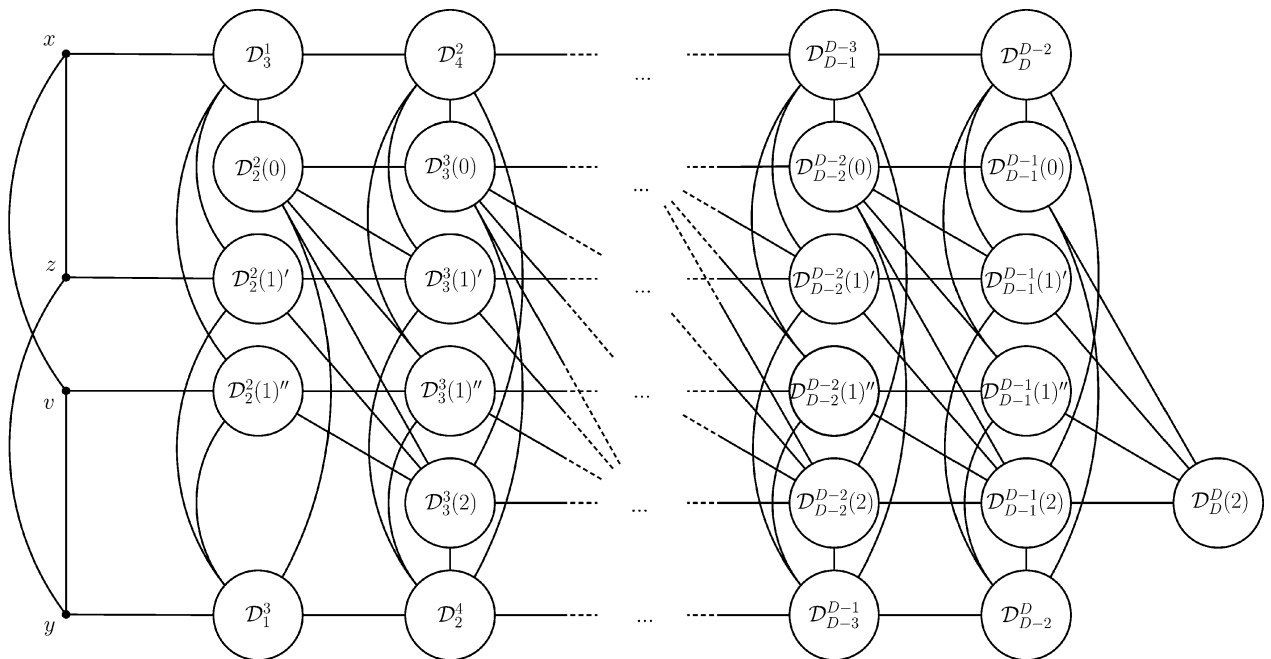

SLIKA 2. Particija vozlišč grafa  $\Gamma$  (glej definicijo 8). Opazimo, da je  $\Gamma_i(x) = \mathcal{D}_{i+2}^i \cup \mathcal{D}_i^i(0) \cup \mathcal{D}_i^i(1)' \cup \mathcal{D}_i^i(1)'' \cup \mathcal{D}_i^i(2) \cup \mathcal{D}_{i-2}^i$  (disjunktna unija) in  $\Gamma_i(y) = \mathcal{D}_i^{i-2} \cup \mathcal{D}_i^i(0) \cup \mathcal{D}_i^i(1)' \cup \mathcal{D}_i^i(1)'' \cup \mathcal{D}_i^i(2) \cup \mathcal{D}_i^{i+2}$  (disjunktna unija).

**Definicija 9** Naj bo  $\Gamma = (X, R)$  dvodelen razdaljno-regularen graf s premerom  $D \geq 4$ , stopnjo  $k \geq 3$  in presečnimi števili  $b_i, c_i$ . Z notacijo definicije 1 predpostavimo, da je  $\Delta_2 = 0$ ,  $c_2 = 2$  in  $\Delta_i \neq 0$  za nek  $i$  ( $3 \leq i \leq D-2$ ). Naj bo

$$f = \min\{i \in \mathbb{N} \mid 3 \leq i \leq D-2 \text{ in } \Delta_i \neq 0\},$$

$$\ell = \max\{i \in \mathbb{N} \mid 3 \leq i \leq D-1 \text{ in } \Delta_i \neq 0\}.$$



Fiksirajmo  $x \in X$ . Za vsak  $y \in \Gamma_2(x)$  naj bosta  $\bar{x}, \bar{y}$  skupna soseda vozlišč  $x$  in  $y$ . Za vsa cela števila  $i, j$  definirajmo množice  $\mathcal{D}_j^i = \mathcal{D}_j^i(x, y)$ ,  $\mathcal{D}_i^i(0) = \mathcal{D}_i^i(0)(x, y)$ ,  $\mathcal{D}_i^i(1)' = \mathcal{D}_i^i(1)'(x, y)$ ,  $\mathcal{D}_i^i(1)'' = \mathcal{D}_i^i(1)''(x, y)$ ,  $\mathcal{D}_i^i(2) = \mathcal{D}_i^i(2)(x, y)$  kot v definiciji 8. Predpostavimo, da za  $f \leq i \leq \ell$  obstajata taki kompleksni števili  $\alpha_i, \beta_i$ , da za vsak  $x \in X$  in  $y \in \Gamma_2(x)$  velja  $H_i = \alpha_i I_i + \beta_i G_i$ , kjer so  $G_i, H_i, I_i$  kot v definiciji 4.

V doktorski disertaciji smo dokazali naslednji izrek.

**Izrek 10** (glej podpoglavje 8.3) *Z notacijo iz definicije 9, naj bo  $y \in \Gamma_2(x)$ . Potem je particija množice  $X$  na na neprazne množice  $\mathcal{D}_{i+1}^{i-1}, \mathcal{D}_{i-1}^{i+1}, \mathcal{D}_i^i(1)' \cup \mathcal{D}_i^i(1)''$  ( $1 \leq i \leq D-1$ ) in  $\mathcal{D}_i^i(0), \mathcal{D}_{i+1}^{i+1}(2)$  ( $f \leq i \leq \ell-1$ ) ekvitalna. Pripadajoči parametri te ekvitalne particije so neodvisni od izbire vozlišč  $x, y$ .*

## O dvodelnih $Q$ -polinomskih razdaljno-regularnih grafih s $c_2 \leq 2$

Poglavje 4 je del prizadevanj za klasifikacijo dvodelnih  $Q$ -polinomskih razdaljno-regularnih grafov. Naš glavni rezultat je naslednji izrek.

**Izrek 11** (glej izrek 4.1) *Naj bo  $\Gamma$  dvodelni  $Q$ -polinomski razdaljno-regularen graf s premerom  $D \geq 4$ , stopnjo  $k \geq 3$  in presečnim številom  $c_2 \leq 2$ . Potem velja natanko ena od naslednjih treh možnosti:*

- (i)  $\Gamma$  je  $D$ -dimenzionalna hiperkocka;
- (ii)  $\Gamma$  je antipodni kvocient  $2D$ -dimenzionalne hiperkocke;
- (iii)  $\Gamma$  je graf s premerom  $D = 5$ , ki ni naveden zgoraj.

Za trenutno stanje klasifikacije  $Q$ -polinomskih razdaljno-regularnih grafov glej [14].

## Nerazcepen $T$ -modul s krajiščem 2 v primeru, ko je $c_2 = 1$

Naj bo  $\Gamma$  dvodelen razdaljno-regularen graf, ki ima lastnost (a.10) v premeru, ko je  $c_2 = 1$ . V poglavju 7 smo opisali strukturo njegovih nerazcepnih  $T$ -modulov s krajiščem 2.

V doktorski disertaciji smo dokazali, da do izomorfizma natančno obstaja samo en nerazcepen  $T$ -modul s krajiščem 2, pri čemer ta modul ni tanek. Poiskali smo bazo tega  $T$ -modula, ter opisali delovanje matrike sosednosti  $A$  grafa  $\Gamma$  na tej bazi.

V disertaciji smo dokazali naslednja dva izreka.

**Izrek 12** (glej izrek 7.34) *Z notacijo iz definicije 6 naj bo  $W$  nerazcepen  $T$ -modul s krajiščem 2. Izberimo si neničelen vektor  $v \in E_2^*W$ . Potem velja naslednje.*

- (i) *Predpostavimo, da je bodisi  $\ell \leq D-2$ , bodisi  $\ell = D-1$  in  $b_{D-1} = 1$ . Potem je*

$$E_i^* A_{i-2} v \quad (2 \leq i \leq \ell), \quad E_i^* A_{i+2} v \quad (f \leq i \leq D-2).$$

*baza  $T$ -modula  $W$ .*

- (ii) *Predpostavimo, da je  $\ell = D-1$  in  $b_{D-1} \neq 1$ . Potem je*

$$E_i^* A_{i-2} v \quad (2 \leq i \leq D), \quad E_i^* A_{i+2} v \quad (f \leq i \leq D-2).$$

*baza  $T$ -modula  $W$ .*



**Izrek 13** (glej izrek 7.39) *Pri predpostavkah definicije 6 sta poljubna dva nerazcepna  $T$ -modula s krajiščem 2 izomorfna.*

### Ireducibilen $T$ -modul s krajiščem 2 v primeru, ko je $c_2 = 2$

Naj bo  $\Gamma$  dvodelen razdaljno-regularen graf, ki ima lastnost (a.10) v premeru, ko je  $c_2 = 2$ . V poglavju 8 smo opisali strukturo njegovih nerazcepnih  $T$ -modulov s krajiščem 2.

V tej doktorski disertaciji smo dokazali, da do izomorfizma natančno obstaja samo en nerazcepen  $T$ -modul s krajiščem 2, pri čemer ta modul ni tanek. Poiskali smo bazo tega  $T$ -modula, ter opisali delovanje matrike sosednosti  $A$  grafa  $\Gamma$  na tej bazi.

V disertaciji sta dokazana naslednja dva izreka .

**Izrek 14** (glej izrek 8.43) *Z notacijo iz definicije 9, naj bo  $W$  nerazcepen  $T$ -modul s krajiščem 2. Izberimo si neničelen vektor  $v \in E_2^*W$ . Potem vektorji*

$$E_i^*A_{i-2}v \quad (2 \leq i \leq \ell), \quad E_i^*A_{i+2}v \quad (f \leq i \leq D-2).$$

*sestavljajo bazo  $T$ -modula  $W$ .*

**Izrek 15** (glej izrek 8.47) *Z notacijo iz definicije 9 velja naslednje.*

- (i) *Do izomorfizma natančno obstaja samo en nerazcepen  $T$ -modul s krajiščem 2.*
- (ii) *Naj bo  $W$  nerazcepen  $T$ -modul s krajiščem 2. Potem je večkratnost  $T$ -modula  $W$  v prostoru  $V$  enaka  $k_2 - k$ .*

### Ireducibilen $T$ -modul s krajiščem 2 v primeru, ko je $D \leq 5$

Naj bo  $\Gamma$  dvodelen razdaljno-regularen graf, ki ima lastnost (a.10) v premeru, ko je  $D \leq 5$ . V poglavju 9 smo opisali strukturo njegovih nerazcepnih  $T$ -modulov s krajiščem 2.

V tej doktorski disertaciji smo dokazali, da do izomorfizma natančno obstaja en sam nerazcepen  $T$ -modul s krajiščem 2, ter da ta modul ni tanek.

V poglavju 9 smo dokazali naslednja dva izreka.

**Izrek 16** (glej izrek 9.10) *Naj bo  $\Gamma = (X, R)$  dvodelen razdaljno-regularen graf s premerom  $D$ , stopnjo  $k \geq 3$ , in naj bo  $W$  nerazcepen  $T$ -modul s krajiščem 2. Izberimo si neničelen vektor  $v \in E_2^*W$ . Potem*

$$W = \text{span}\{v_2^+, v_3^+, \dots, v_D^+, v_2^-, v_3^-, \dots, v_{D-2}^-\}.$$

*kjer je  $v_i^+ = E_i^*A_{i-2}E_2^*v$  in  $v_i^- = E_i^*A_{i+2}E_2^*v$ .*

**Izrek 17** (glej izrek 9.23) *Naj bo  $\Gamma = (X, R)$  dvodelen razdaljno-regularen graf s premerom  $D \leq 5$ , stopnjo  $k \geq 3$  in  $z \Delta_2 = 0$ . Potem sta poljubna nerazcepna  $T$ -modula s krajiščem 2 izomorfna.*

## Metodologija

Osnovna orodja, uporabljena v našem raziskovanju, segajo od kombinatoričnih in algebraičnih metod v teoriji grafov, uporabe linearne algebre v matričnih algebrah, do popolnoma

abstraktnih premislekov v sklopu abstraktne algebre in Wederburnove teorije. Skozi celoten potek raziskovanja smo za testiranje rezultatov uporabljali računalniški program MathWorks MATLAB. Odgovore smo dodatno testirali tudi z uporabo računalniškega programa MAGMA (programski paket namenjen za izračune v algebri, teoriji števil, algebraični geometriji in algebraični kombinatoriki).

Pri problemu dokazovanja, da je dvodelen  $Q$ -polinomski razdaljno-regularen graf  $\Gamma$  s presečnim številom  $c_2 \leq 2$  bodisi  $D$ -dimenzionalna hiperkocka, bodisi antipodni kvocient  $2D$ -dimenzionalne hiperkocke, bodisi je  $D = 5$ , smo uporabili kombinatorične in algebraične metode, podobne tistim, ki so uporabljane v [38].

Pri problemu iskanja ekvitalne particije za dvodelne razdaljno-regularne grafe s presečnim številom  $c_2 \leq 2$ , smo uporabili kombinatorične metode, podobne tistim, ki so uporabljane v [35, 38, 42].

Pri problemu opisa nerazcepnih  $T$ -modulov s krajiščem 2 smo uporabili metode linearne algebre, podobne tistim, ki so uporabljane v [9, 28, 42].

---

# Kazalo

---

Zahvala	iii
Izveček (v angleščini)	v
Izveček (v slovenščini)	vii
Kazalo (v angleščini)	ix
<b>1 Uvod</b>	<b>1</b>
<b>2 Teoretična izhodišča: Algebra sosednosti in Bose-Mesner-jeva algebra</b>	<b>4</b>
2.1 Osnovne definicije . . . . .	4
2.2 Primitivni idempotenti . . . . .	6
2.3 Algebra sosednosti in Bose-Mesner-jeva algebra . . . . .	10
2.4 Skalarni produkt v $\text{Mat}_X(\mathbb{F})$ in $\mathbb{F}_d[x]$ . . . . .	13
2.5 Kreinovi parametri $q_{ij}^h$ . . . . .	16
<b>3 Razdaljno-regularni grafi (RRG)</b>	<b>20</b>
3.1 Razdaljno-regularen graf . . . . .	20
3.2 Standardni modul . . . . .	23
3.3 Zaporedje dualnih lastnih vrednosti . . . . .	24
3.4 $Q$ -polinomska lastnost . . . . .	24
3.5 Primeri . . . . .	26
3.5.1 Johnsonovi grafi . . . . .	27
3.5.2 Hammingovi grafi in kocke . . . . .	27
3.5.3 Polovična kocka . . . . .	28
3.5.4 Antipodni kvocient kocke . . . . .	28
<b>4 Dvodelni <math>Q</math>-polinomske RRG s <math>c_2 \leq 2</math></b>	<b>29</b>
4.1 Primer $D \geq 6$ . . . . .	29
4.2 Particija - prvi del . . . . .	31
4.3 Particija - drugi del . . . . .	35
4.4 Primer $D = 4$ . . . . .	37
<b>5 Terwilligerjeva algebra</b>	<b>41</b>
5.1 Dualna Bose-Mesner-jeva algebra . . . . .	41
5.2 Terwilligerjeva algebra . . . . .	41
5.3 Nerazcepni $T$ -modul s krajiščem 0 . . . . .	45

5.4	Nerazcepni $T$ -modul s krajiščem 1 . . . . .	46
5.5	Opomba o primeru, ko je $\Gamma$ tanek . . . . .	47
5.6	Matriki $R$ in $L$ . . . . .	48
<b>6</b>	<b>Skalarji <math>\Delta_i</math></b>	<b>49</b>
<b>7</b>	<b>O Terwilligerjevi algebr dvodelnih RRG s <math>c_2 = 1</math></b>	<b>52</b>
7.1	Preslikave $G_i, H_i$ in $I_i$ . . . . .	52
7.2	Mnozice $\mathcal{D}_i^i(0), \mathcal{D}_i^i(1)$ in particija . . . . .	54
7.3	Nekaj produktov v $T$ . . . . .	57
7.4	Nekaj produktov v $T$ - nadaljevanje . . . . .	59
7.5	Nekaj skalarnih produktov . . . . .	61
7.6	Nerazcepni $T$ -moduli s krajiščem 2 . . . . .	62
7.7	Nerazcepni $T$ -moduli s krajiščem 2: delovanje matrike $A$ . . . . .	63
7.8	Izomorfn razred nerazcepnega $T$ -modula s krajiščem 2 . . . . .	64
<b>8</b>	<b>O Terwilligerjevi algebr dvodelnih RRG s <math>c_2 = 2</math></b>	<b>65</b>
8.1	Mnozice $\mathcal{D}_j^i, \mathcal{D}_i^i(1)$ in $\mathcal{D}_i^i(2)$ . . . . .	65
8.2	Preslikave $G_i, H_i$ in $I_i$ . . . . .	69
8.3	Ekvitalna particija . . . . .	70
8.4	Nekaj produktov v $T$ . . . . .	71
8.5	Nekaj produktov v $T$ - nadaljevanje . . . . .	73
8.6	Nekaj skalarnih produktov . . . . .	74
8.7	Nerazcepni $T$ -moduli s krajiščem 2 . . . . .	76
8.8	Nerazcepni $T$ -moduli s krajiščem 2: delovanje matrike $A$ . . . . .	77
8.9	Izomorfn razred nerazcepnega $T$ -modula s krajiščem 2 . . . . .	78
<b>9</b>	<b>O Terwilligerjevi algebr dvodelnih RRG z <math>D \leq 5</math></b>	<b>79</b>
9.1	Uvod . . . . .	79
9.2	Nekaj produktov v $T$ . . . . .	80
9.3	Nerazcepni $T$ -moduli s krajiščem 2 . . . . .	81
9.4	Primer ko je $\Delta_2 = 0$ in $\Delta_3 \neq 0$ . . . . .	82
9.5	Nekaj skalarnih produktov . . . . .	83
9.6	Baza . . . . .	85
	<b>Literatura</b>	<b>87</b>
	<b>Povzetek v slovenskem jeziku</b>	<b>94</b>
	Kazalo (v slovenščini) . . . . .	104
	Stvarno kazalo (v slovenščini) . . . . .	106
	<b>Stvarno kazalo (v angleščini)</b>	<b>106</b>
	<b>Izjava</b>	<b>107</b>

---

# Stvarno kazalo

---

- $A_i$ , 5
- $E_i$ , 7
- $G_i(z)$ , 52, 69
- $H_i(z)$ , 52, 69
- $I_i(z)$ , 52, 69
- $T$ -modul, 41
- $\mathcal{D}_j^i$ , 52
- $\mathcal{D}_i^i(0)$ , 54, 66
- $\mathcal{D}_i^i(1)$ , 54
- $\mathcal{D}_i^i(1)'$ , 66
- $\mathcal{D}_i^i(1)''$ , 66
- $\mathcal{D}_i^i(2)$ , 66
- $\mathcal{D}_j^i$ , 65
- $\Delta_i$ , 49
- $E_i^*$ , 41
- $\Gamma_{ij}(x, y)$ , 52, 65
- $\Lambda_i$ , 79
- $\alpha_i$ , 53
- $\beta_i$ , 53
- $\ell$ , 50, 54, 70
- $\gamma_i$ , 49
- $\omega_{ii}^+$ , 53
- $\omega_{ii}^-$ , 53
- $\omega_{ij}$ , 53
- $\phi$  homogena komponenta, 44
- $\rho(x)$ , 18
- $d$ -kocka, 27
- $f$ , 50, 54, 70
- $i$ -ta razdaljna matrika, 5
- $v_i^+$ , 61, 74, 81
- $v_i^-$ , 61, 74, 81
- adjungirana linearna preslikava, 6
- algebra, 6
  - Bose-Mesner-jeva, 10
  - dualna Bose-Mesner-jeva, 41
  - koherentna, 6
  - sebi-adjungirana, 6
  - sosednosti, 10
  - Terwilligerjeva, 41
- asociativna shema, 6
  - komutativna, 6
  - simetrična, 6
- diameter, 5
- direktna vsota, 5
- dualna lastna vrednost, 24
  - trivialna, 24
- dualno dvodelen, 26
- ekvatabilna particija, 29
- graf, 4
  - $Q$ -polinomski glede na lastno vrednost  $\theta$ , 25
  - $Q$ -polinomski glede na matriko  $E$ , 25
  - $d$ -dimenzionalna kocka, 27
  - antipoden, 28
  - antipodni kvocient, 28
  - dualno dvodelen, 26
  - dvodelen, 22
  - enostaven, 4
  - Hamming-ov, 27
  - Johnson-ov, 27
  - končen, 4
  - povezan, 5
  - razdaljno-regularen, 5, 20
  - regularen, 5
- Hermitiski skalarni produkt, 4
- izomorfizem  $T$ -modulov, 42
- klika, 4
- Kreinovi parametri, 16, 25
- lastna vrednost, 24
  - večkratnost, 24
- linearna preslikava
- projektor, 5

- matrika
  - $L$ , 48
  - $R$ , 48
  - $i$ -ta razdaljna, 5
  - sosebnosti, 5
- modul
  - $T$ -modul, 41
  - diameter, 42
  - krajišče, 42
  - nerazcepen, 41
  - primarni, 45
  - standardni, 4
  - tanek, 47
  - tanek glede na vozlišče  $x$ , 42
- moduli
  - izomorfni, 42
- nerazcepen modul
  - večkratnost, 44
- normalna preslikava, 6
- ortogonalni projektor, 6
- podprostor
  - komplementaren, 5
- polovična kocka, 28
- povezave, 4
  - zanka, 4
- predrazdaljni polinomi, 16
- premer, 5
- presečna števila, 21
- primitivni idempotenti, 7
- pripadajoči parametri, 29
- razdalja, 5
- razdaljna matrika, 5
- regularen z valenco  $k$ , 5
- sebi-adjungirana preslikava, 6
- skalarni produkt, 13
- sprehod, 5
  - obhod, 5
- standardni modul, 23
- vektor
  - ortogonalna preslikava, 5
  - projekcija, 5
- vozlišča, 4
  - sosebnja, 4

---

# Declaration

---

I declare that this thesis does not contain any materials previously published or written by another person except where due reference is made in the text.

Safet Penjić